

TORMACH PSG 612 2-AXIS SEMI-AUTOMATIC PERSONAL SURFACE GRINDER

Operator's Manual



**Questions or comments?
Please e-mail us at:
info@tormach.com**



**Tormach PSG 612 Manual:
UM10159_PSG612_Operators_Manual_0314A**

© 2014 Tormach® LLC. All rights reserved.

TABLE OF CONTENTS

1. Scope of Documentation	2
Customer Service	2
About the PSG 612	2
Intended Use	2
Product Features	2
Components	3
Tool Box Inventory	4
Specifications	5
2. Risks of Machinery	6
Basic Machine Safety	6
Operating Safety	6
Electrical Safety	7
For Lifting	7
For Assembly	7
3. Installation	8
Unpacking	8
Assembly	8
Protecting from Rust	8
Lubrication	8
4. Grinder Operation	11
Control Modes and Power Controls	11
Speed and Feed	11
Wheel On/Wheel Off	11
Start/Stop	11
E-Stop	11
Power Mains	11
Powering Up the Machine	12
Using the Magnetic Chuck	12
5. Working With Wheels	13
Adjusting Table Flags	13
Installing a Grinding Wheel	13
Ring Test	14
Replacing the Hub on a Grinding Wheel	14
Wheel Balancing	15
Dressing a Wheel	16
6. Machine Maintenance	17
Backlash Adjustment	17
Gib Screw Adjustment	17
Changing /Cleaning Air Filters	17
Replacing Fuse	18
Replacing the Y Axis Belt	18
Machine Storage	19
7. Electrical Cabinet Components	20
8. Exploded Views	21
9. Troubleshooting	27
10. Warranty	30
11. Index	32

SCOPE OF DOCUMENTATION

The purpose of this manual is to help the reader understand how to prepare for, operate, and maintain the Tormach 2-Axis Semi-Automatic Personal Surface Grinder PSG 612.

While the reader may not have an intimate understanding of the Tormach 2-Axis Semi-Automatic Personal Surface Grinder PSG 612, we assume they have a basic understanding of how to operate this type of machine.

As with all machinery of this nature, learning the nuances of operation is a process that happens through training and experience. If you are not an experienced operator of this type of machinery, read through this entire manual, then learn more from an experienced operator, schooling, or research before attempting operations. Following this advice will help you avoid serious personal injury and get the best results from your work.

Tormach intends to be as accurate as possible in creating technical documentation. That said, periodically manuals are updated to add or remove content to improve the overall accuracy and usability. We use an alpha-numeric revision control method that is identified in the footer of each page. For example, 0413B is the second update to the document in the month of April 2013.

The current version of the manual is made available in electronic format on <http://www.tormach.com/documents.html>. Tormach values customer feedback as it relates to documentation. If you have feedback, positive or constructive, please send an email to info@tormach.com.

Customer Service

Tormach provides technical support through multiple channels. The quickest ways to receive technical support and the answers you need are through one of the methods listed below:

- This manual: always the first place to check
- Tormach online:
www.tormach.com/documents.html
- Email: info@tormach.com
- Telephone: 608-849-8381
- Fax: 209-885-4534
- Watch PSG 612 Videos online by scanning the QR code or visiting:
www.tormach.com/grindervideos



About the PSG 612

Intended Use

The Tormach 2-Axis Semi-Automatic Personal Surface Grinder PSG 612 is a 6" X 12" semi-automatic personal surface grinder. It is intended for use as a general purpose surface grinder for grinding ferrous materials including cast iron, mild steel, and alloy steels. Grinding other materials may be possible, but may require specialized grinding wheels and or specialized grinding techniques. Tormach limits support and warranty when products are used outside the scope of a product's intended purpose.

All applicable warranties for this equipment are voided through modification to the equipment or use outside of the Intended Use. Individuals or companies involved with modifying the equipment or applying the products assume all consequent liability. Refer to the warranty and liability sections at the end of this manual for additional information.

Product Features

A surface grinder allows you to smooth the surface of metallic work pieces, utilizing a semi-automatic table that moves on a horizontal plane and a grinding wheel that moves along a vertical axis. By mounting a work piece to the table with a magnetic chuck, then moving the table and the grinding wheel during the grinding process, extremely small amounts of material can be removed to create high-tolerance flat surfaces.

The PSG 612 is equipped with easy-to-reach front-mounted handwheels for controlling table movement to position the wheel manually.

The table travels in the longitudinal direction (X) on a hydrodynamic (oil film) slideways table, driven by a rack-and-pinion mechanism. Vertical (Z) travel is driven by a manually-operated leadscrew with a counterweight for controlled positioning. Crossfeed travel (Y) is driven by a leadscrew. Both X and Y are automatic and can also be positioned manually.

The stand doubles as a storage cabinet where you can keep the necessary tools and extra grinding wheels right where you need them.

Components

1. Control Panel
2. Power Disconnect
3. Table Jog Handwheel
4. Storage Cabinet
5. Cross Feed Handwheel
6. Table Flags (X)*
7. Shield Plate
8. Grinding Wheel
9. Vertical Adjustment Handwheel
10. Emergency Stop Button

* Table Flags (Y) (Not Shown)



WARNING: SERIOUS PERSONAL INJURY COULD OCCUR IF YOU CONNECT THE MACHINE TO POWER BEFORE COMPLETING THE SETUP PROCESS. DO NOT CONNECT POWER UNTIL INSTRUCTED TO DO SO LATER IN THIS MANUAL.



WARNING: UNTRAINED USERS HAVE AN INCREASED RISK OF SERIOUSLY INJURING THEMSELVES WITH THIS MACHINE. DO NOT OPERATE THIS MACHINE UNTIL YOU HAVE UNDERSTOOD THIS ENTIRE MANUAL AND RECEIVED PROPER TRAINING.



Tool Box Inventory

Qty	Part
1	Metal Tool Box (Not Shown)
1	Cabinet Lock Keys
1	Balancing Arbor
1	Adjustable Spanner Wrench
1	Diamond Dresser (in Protective Case)
1	Diamond Dresser Base
3	Hex Wrenches
4	Machine Foot Assemblies (Feet, Studs, Nuts and Washers)
1	Grinding Wheel Hubs
2	Auxiliary Clamps and Bolts w/Nuts
1	Adjustable End Wrench
1	Dual Open End Wrench
1	Spindle Wrench
2	Screwdriver

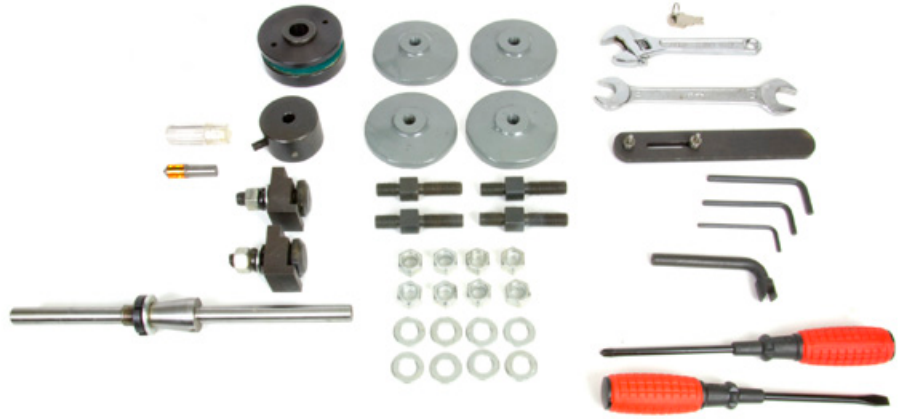

Specifications

Product Dimensions:

Dimensions/Weight:	
Table Size	6" X 12"
Table Slots	1 Slot: 1/2" X 15 1/2" T
Longitudinal Max Travel	13 7/8"
Cross Feed Max Travel	8 1/4"
Min / Max Distance to Spindle Center	3" min, 12" max
Maximum Working Height (Above Table)	8 3/4"
Elevation (Z) Graduation	0.001"
Floor to Table Height	40"
Space Required for Full Range of Movement	51" W X 66" H X 30" D
Stand Footprint	24" X 24"
Approximate Shipping Weight	530 lbs.
Weight	400 lbs.
Crate Dimensions	43 1/2" W X 66" H X 30" D
Max Workpiece	400 lbs.

Power:	
Power Requirements	Single Phase, 110-123 V, 50/60 Hz 8 Amp Peak / 4 Amp Continuous 15 A Breaker Recommended

Spindle:	
Spindle Motor	Industrial Grade 3/4 HP TEFC Single Phase, 115 V 60 Hz 7 Amp Peak Induction Motor
Wheel Size	7" X 1 1/4" X 1/2" Hub
Wheel RPM	3450 RPM (@60 Hz) providing 6300 SFM
Spindle Bearing	P6

Iron:	
Frame and Table	Cast Iron with Hand-Scraped Hydrodynamic Dovetailed Slide Ways and Tapered Adjustment Gibs
Slide Way Surfaces	Low Friction PTFE-filled Acetyl Bonded Sliding Surface, Similar to Turcite® or Rulon®

Motion:	
Feedrate	0-45 ft/min Longitudinal (X) 0-24 ft/min Cross Feed (Y)
Axis Drives	NEMA 34 Stepper Motors with Leadshine® High Performance Microstepping Drivers
Motion	Longitudinal: Rack and Pinion (Automatic) Cross: Leadscrew w/ Anti-backlash Nut (Automatic or Manual) Vertical: Leadscrew w/ Anti-Backlash Nut (Manual)
Vertical Handwheel Graduation	0.0005" (0.012mm)

Control:	
Operator Console	Wheel On/Off, Speed and Cross Feed Control, Power On, E-Stop, 4-Mode Automatic Feed

Other Features:	
Paint	2-Part Copolymer Enamel, Cross-linked Acrylic /Modified Amino Resin
Stand	Sheet Metal With Storage Cabinet and Adjustable Footpads
Lubrication	Single Shot Distribution, 7 Points

1 Year Warranty:	
Standard Warranty	12 Month Tormach Standard Warranty
Extended Warranty	12 Month Optional Extended Warranty, Renewable Yearly

Any machine tool is potentially dangerous. Grinding wheels are brittle and can burst without warning. The combination of a loose or misaligned work piece with the

RISKS OF MACHINERY

inertia of a spindle motor and grinding wheel will usually result in damage to both work and the machine. If loose hair, clothing, gloves, or jewelry gets caught by a rotating piece the results can be disastrous. It is the operator's responsibility to ensure for his own personal safety, as well as the safety of bystanders, should such an incident occur.

This manual tries to give you guidance on safety precautions and techniques, but because we do not know the details of your workshop or other local conditions we cannot accept responsibility for the performance of your machine or any damage or injury caused by its use. It is your responsibility to ensure that you understand the implications of what you are doing and to comply with any legislation and codes of practice applicable to your country or state.

Operating all machinery and machining equipment can be dangerous or relatively safe depending on how it is installed and maintained, and the operator's experience, common sense, risk awareness, working conditions, and use of personal protective equipment (safety glasses, respirators, etc.).

The owner of this machinery or equipment is ultimately responsible for its safe use. This responsibility includes proper installation in a safe environment, personnel training and usage authorization, regular inspection and maintenance, manual availability and comprehension, application of safety devices, integrity of cutting tools or accessories, and the usage of approved personal protective equipment by all operators and bystanders.

The manufacturer of this machinery or equipment will not be held liable for injury or property damage from negligence, improper training, machine modifications, or misuse. Failure to read, understand, and follow the manual and safety labels may result in serious personal injury, including amputation, broken bones, electrocution, or death.

The symbols used in this manual to identify hazard levels are defined as follows:



WARNING: INDICATES A POTENTIALLY HAZARDOUS SITUATION THAT, IF NOT AVOIDED, COULD RESULT IN SERIOUS INJURY OR DEATH.



CAUTION: INDICATES A POTENTIALLY HAZARDOUS SITUATION THAT, IF NOT AVOIDED, COULD RESULT IN INJURY. CAUTIONS ARE ALSO USED TO DRAW ATTENTION TO UNSAFE PRACTICES OR ADVERSE OPERATING CONDITIONS.

Note: Indicates supplemental information and instructions on proper operating conditions/ techniques.

Basic Machine Safety

Operating Safety

Safe operation of the machinery depends on its proper use and precautions taken by each operator.

Read and understand this manual. Be certain every operator understands the proper operation and safety requirements before using the machine.

1. Do not operate this machine without knowing the function of every control key, button, knob or handle. Refer to the manual or contact Tormach if any function is not understood.
2. Never operate this machine with unbalanced or damaged grinding wheels.
3. Protect your eyes. Wear approved safety glasses (with side shields) at all times.
4. Ear protection should be used on any operations that exceed sound levels of 85dBa.
5. Never wear rings, watches, long sleeves, neckties, jewelry or other loose items when operating or working around the machine. Long hair should be bound or kept under a hat.
6. Do not wear gloves while operating the machine. Gloves are easily caught in moving parts or cutting tools.
7. Never operate the machine after consuming alcoholic beverages or taking strong medication.
8. Protect your hands. Stop the machine spindle and ensure that the computer control is stopped before

you:

- a. Change tools;
 - b. Change parts or adjust the work piece;
 - c. Clear away chips or debris – always use a chip scraper or brush;
 - d. Make an adjustment to the part, fixture, or take measurements;
9. Keep work area well lit. Ask for additional light if needed.
 10. Use proper grinding wheels for the job.
 11. Chips and dust from certain materials (e.g., magnesium) can be flammable. Fine dust from normally non-flammable materials can be flammable or even explosive.
 12. Chips and dust from certain materials can be toxic. Vapors from certain overheated materials can be toxic. Always check a Materials Safety Data Sheet (MSDS) of suspect materials. Refuse machining work requests of unknown materials.
 13. If you are in any doubt you must seek guidance from a professionally qualified expert rather than risk injury to yourself or to others.
 14. Always stop the grinder and check to ensure the machine is in stop mode before adjusting the tool or work piece.
 15. Use adequate safeguarding around the operating envelope.

It is the responsibility of the employer to provide and ensure point of operation safeguarding per the following:

- OSHA 1910.212 - General Requirements for All Machines
- ANSI B11.09-2010 Safety Requirements for Grinding Machines
- ANSI B11.TR3-2000 Risk Assessment and Risk Reduction - A Guideline to Estimate, Evaluate, and Reduce Risks Associated with Machine Tools

Electrical Safety



Power Input: The power input should be unplugged before working in the electrical cabinet.

Grounding: Power inputs must be grounded.

During installation it is not enough to assume that the ground line of a wall outlet is properly grounded. Check continuity between the machine frame and true earth ground (water pipe or similar) to ensure a good ground connection.

Electrical Panel: NEVER operate the grinder with the cabinet door open.

Retained Electrical Power: Electronic devices within the electrical cabinet may retain dangerous electrical voltages after the power has been removed.

Electrical Service: Certain service and troubleshooting operations require access to the electrical cabinet while the electrical power is on. Only qualified electrical technicians should perform such operations.

In preparation for installing the Tormach 2-Axis Semi-Automatic Personal Surface Grinder PSG 612 Surface Grinder you will need to identify a workspace that is large enough to accommodate the machine foot print. Select a workspace that is relatively level and away from exposure to moisture or vibrations.



CAUTION: TORMACH STRONGLY RECOMMENDS INSTALLATION AND ASSEMBLY BE COMPLETED WITH THE ASSISTANCE OF ANOTHER PERSON.

During the installation process you will need the following items:

For Lifting

- A forklift, engine hoist, or other mechanical lifting device rated for the weight of the machine.
- A chain or clevis rated for at least 1500 pounds.

For Assembly

- Machine Foot Assemblies (Included)
- Crowbar
- Level

Unpacking

The Tormach PSG 612 will arrive in a shipping crate or pallet jack designed to be moved with a forklift at the base.

INSTALLATION

Tormach recommends leaving the machine bolted to the crate until it is moved to the installation location.

Note: If you notice any transport damage to the shipping container or machine, please call Tormach Customer Service at 1-608-849-8381 before proceeding with the installation instructions.



CAUTION: DO NOT APPLY ANY FORCE TO THE TABLE WHILE MOVING THE MACHINE UNLESS THE RODS AND STRAPS USED DURING SHIPPING ARE IN PLACE. THE TABLE IS A SLIDING MECHANISM HELD IN PLACE BY ITS OWN WEIGHT AND A CROSS FEED SCREW. TILTING THE TABLE IN AN UPRIGHT POSITION CAN DAMAGE THE CROSS FEED SCREW.

Assembly

1. Using a crowbar, remove the sides of the shipping crate.
2. With the grinder base still connected to the base of the crate, reach underneath the crate to un-thread and remove the four bolts and washers used to secure the base to the crate.
3. Temporarily remove the X table: Remove the X table flags and carefully lift the table off of the machine saddle. This provides better balance when lifting the machine from the lifting point.
4. Connect the chain or clevis to the eye bolt located at the top of the grinder.
5. Using the forklift or mechanical lifting device, carefully lift the grinder up from the base of the crate.
6. Pull the base of the crate out and away from the grinder.
7. Thread the stud, nut, and washer onto the machine foot and screw the machine foot assembly into the bottom of the grinder cabinet as shown in the following photo.
8. Slowly lower the machine to the ground at its desired location and replace the table and table flags.
9. Level the machine, adjusting the position of each machine foot assembly as necessary.



Protecting from Rust

Exposed iron and steel surfaces should always be protected from rust and corrosive environments. If your grinder will be unused for more than a couple days, you should mist the surfaces with light water repellent oil such as WD-40.

Initial Lubrication

The X-axis has a bonded layer of plastic compound, a composition of Acetyl and PTFE similar to Turcite®. This is state of the art technology for oil lubricated slideways and superior to plain ground surfaces or hardened and chromed surfaces.

When properly maintained, sliding surfaces will last for a long time. If you use the oil lubrication system properly the slideways are not normally maintenance items.

The central lubrication pump should be filled with quality way oil. We recommend Perkins Perlube WL-68 (Tormach Part Number 31386). Other acceptable alternatives are Tonna 68 (Shell), Vactra No. 2 (Mobil), Way-lube 68 (Sunoco), WayLube 68 (Texaco), Febis 68 (Esso) or equivalent oil.



A shot of lubrication should be given **for each 4 hours** of operation and after the machine has stood unused for **more than 48 hours**.

Always make certain that the lubrication oil is clean. The oil is delivered to 7 points throughout the machine. This includes (reference the Lubrication Schematic on the next page):

- X-Front
- X-Back
- Y-Right
- Y-Left
- X-Drive Shaft
- Z-Ways
- Y-Leadscrew

These are some of the most critical and expensive mechanical parts of the machine. Any dirt or foreign material suspended in the oil is going to be delivered directly to these parts and can dramatically shorten the effective life of the machine.

Be sure to clean off the cover and surrounding area before refilling the oil reservoir. The strainer at the top of the reservoir is only a screen; it is not a filter.

Your PSG 612 comes standard with a single shot manual oil pump. An optional Automatic Oiler is also available (Tormach Part Number 31373).

Notes:

- **The pump is spring loaded, where the spring force creates a very light hydraulic pressure. You can get the oil out quicker by pushing a bit, but apply too much force and you can pop off one of the oil lines.**
- **You will have a more uniform distribution of oil if the machine is moving when the hydraulic pressure is applied.**
- **The pump sucks up oil from the reservoir on the pull stroke and delivers it to the machine on the push stroke. If at some point the oil pump seems to move much easier on the push stroke then make certain that you do not have a broken oil line.**
- **Extreme axis positions can expose the oil distribution channels that are cut into the way support saddle surfaces. If the pump is used in**





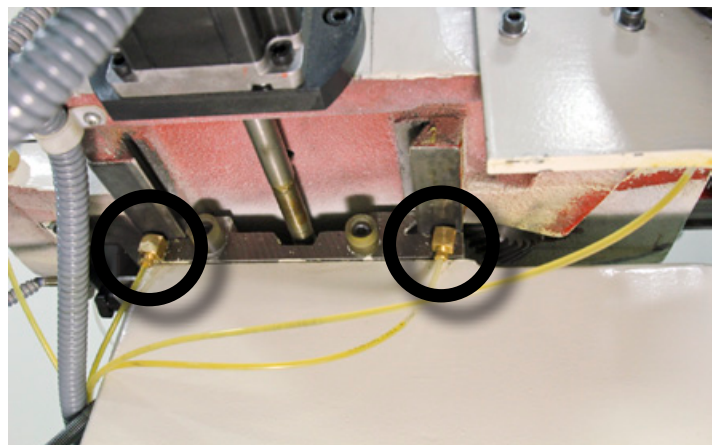
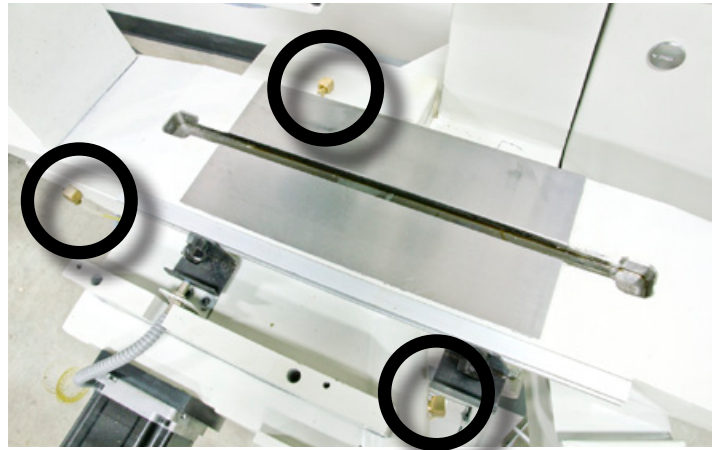

those positions the hydraulic force of the oil will not apply it throughout the machine as intended. Instead the oil will simply squirt out at the point where the oil channel is exposed.

- **After a long period of inactivity or in cold conditions the oil system may become clogged. See Tormach Service Bulletin SB0031 – Flushing the Lubrication System in the Event of a Clog.**



P-29

Compression Fittings

-  Elbow (31311)
-  Nut (31310)
-  Ferrule (31309)
-  Manifold Orifice (31370)
-  Gib Orifice (31408)
-  Nut and Ferrule Bundle (31409)
-  4mm Nylon Tubing (31304)

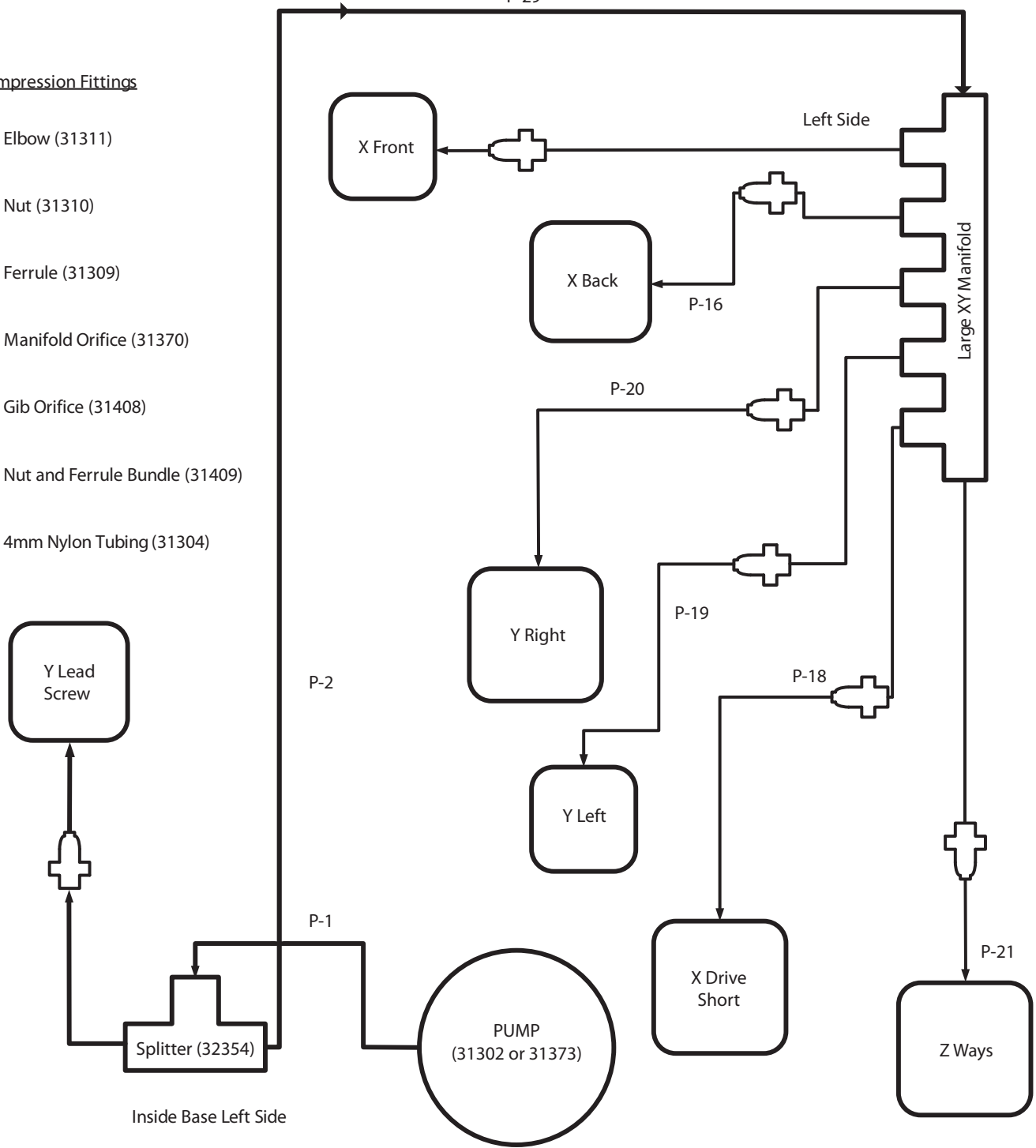

Control Modes and Power Controls



	Mode Select Button	Push this button to switch between grinding modes. Each mode has a green LED below the mode symbol to indicate the mode is active. The machine will not change feed modes while in motion.
	Feed at Both Ends	The grinder feeds in the Y-axis at each end of the X-axis stroke.
	Feed at Left End Only	The grinder feeds in the Y-axis at the left end of each X-axis stroke.
	Continuous Feed	The Y-axis is in continuous feed at set feed.
	No Feed	Use this feed for plunge grinding. No Y-axis motion.

Speed and Feed

The speed and feed knobs are used to control the motion of the work table. Speed controls X-axis motion and Feed controls how far the table moves in the Y-axis. Turn the knobs in a clockwise direction to increase speed or feed.

Wheel On/Wheel Off

The Wheel On and Wheel Off buttons turn the grinding wheel on and off, respectively. Wheel Off will not stop the X- or Y-axis.

Start/Stop

The Start/Stop button starts and stops table motion.

E-Stop

The E-Stop button supplies power to the machine. Rotate to power up

Main Power Disconnect

The Power Mains switch (located on the side of the control panel) completely disconnects the machine from an electrical power source.

Powering Up the Machine

1. Connect the main power cord to an approved IEC wall outlet.
2. Turn the main disconnect located on the side of the cabinet to on.
3. Rotate the red emergency (E-stop) knob located on the electrical box.
4. All of the LED lights on the control panel will blink once, indicating power to the machine.
5. If either of the LED lights for the speed or feed button is active (red), the table is outside the defined range of motion and the table is tripping a proximity switch.
6. Manually adjust the table in the X- or Y- direction if necessary. The table should move freely.
7. When the table location is within the limits, the red LED lights will turn off.
8. Select the desired grinder operation mode by pushing the Mode Select button until the LED light to that operation turns green.
9. Press/toggle the black start button to start and stop table motion. The E-Stop button should be used in emergency situations and to completely terminate power to the machine.

Using the Magnetic Chuck

To install the Magnetic Chuck (Tormach Part Number 33210) for workholding:

1. Locate the auxiliary clamps with bolts and nuts (included in the tool box).
2. Wipe the table surface clean, removing any debris or material.
3. Place the magnetic chuck on the grinding surface.
4. Insert the bolts in the T-slots located on either side of the magnetic chuck.

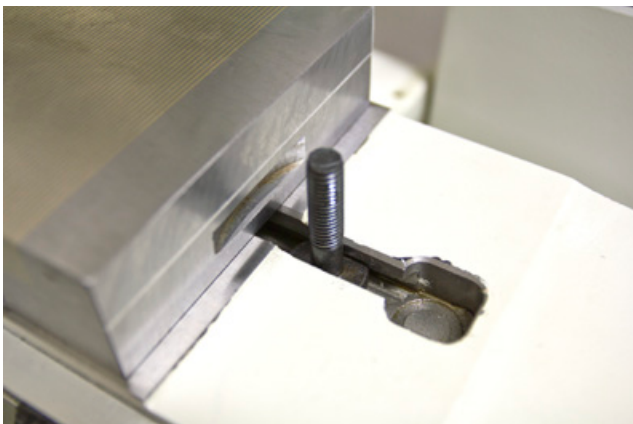

5. Lower the clamps down onto the bolts and then slide the fixture into the grooves on each side of the magnetic chuck.

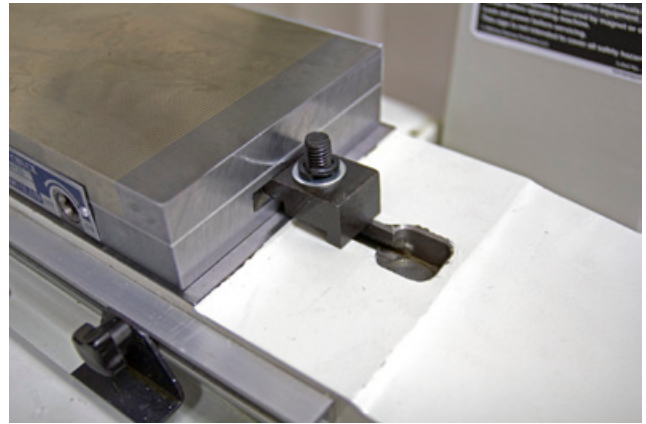

6. Slide the washer and nut down onto the top of the bolts and tighten.



7. Insert the wrench into the slot on the front face of the magnetic chuck. Rotate the wrench to the direction of "on" or "off" to activate or deactivate the magnetic field.



Adjusting Table Flags

Adjust the distance between the X-axis and Y-axis table flags to the size of the part being ground.

To set the X-axis and Y-axis travel limits, move the table flags to the desired location by loosening and sliding the thumbscrews.

Note: Different table speeds will produce different amounts of overtravel. As an example, with slow table movement the table will stop quicker in a smaller distance than when the table speed is faster. You may need to adjust the table flags if you change your table speed.

Note: The thumbscrews must remain on opposite sides of the proximity switch located in the center of the grinding surface under the table guard. If both screws (table flags) are moved to either side of the proximity switch, the table will not run. If the proximity switch is defective, the LEDs will not light.

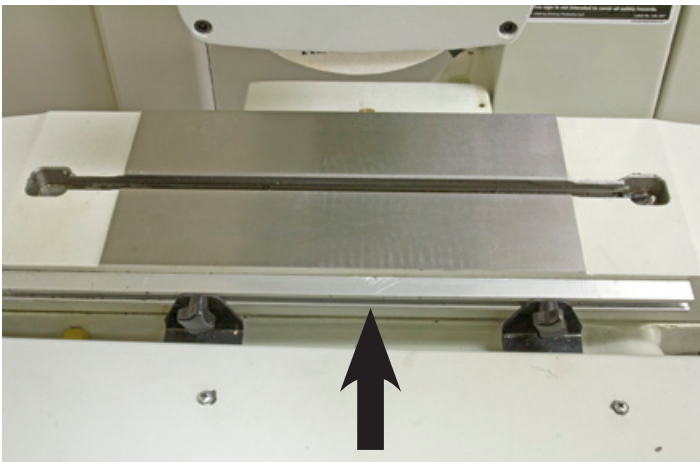

Keep the travel flags on opposite sides of the proximity switch located under the table guard.

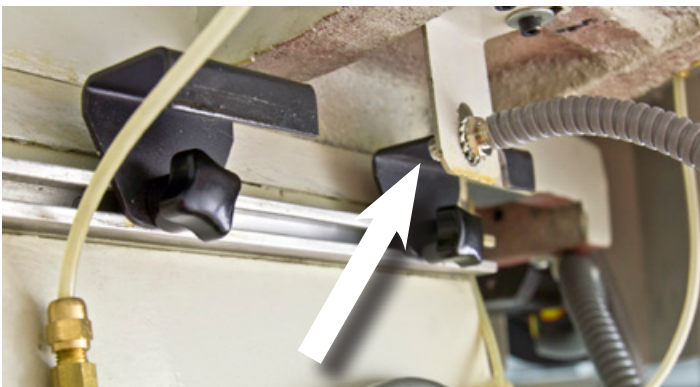

Installing a Grinding Wheel



CAUTION: NEVER INSTALL A GRINDING WHEEL THAT HAS NOT BEEN PROPERLY BALANCED.

There are many reasons for changing the grinding wheel. These include changing the type of material that is being ground or changing the grit type of the wheel itself (for example, from fine to coarse). Over time the grinding wheel will experience wear and will need to be replaced.

1. Remove the three socket head cap screws that hold the wheel guard cover.



2. Set the wheel guard cover to the side.
3. Using the spanner wrench, remove the spindle nut.

Note: The spindle nut is a left-hand thread.



4. Firmly grasp the grinding wheel with one hand and remove the hub. If the wheel spins freely, you will need to hold the wheel in one hand while you insert the spindle wrench in the slot on the back side of the spindle motor.



7. Also ensure the spindle taper is wiped clean.
8. Gently place the new wheel onto the spindle and install the nut, keeping in mind it is a left-hand thread.
9. Hold the wheel in one hand and tighten it down with a spanner wrench.

Note: You may need to re-insert the spindle wrench in the slot on the back side of the spindle motor. Do not over tighten.

10. Replace the cover and the socket head cap screws.

Ring Test

Lightly tap the circumference of the grinding wheel with a metal object (a wrench works fine). Listen for consistent ringing sounds. There should be no dead tones as you tap in several locations around the wheel.



CAUTION: THE GRINDING WHEEL SHOULD BE PROPERLY BALANCED AND DRESSED BEFORE FIRST USE.



Note: You may need to lightly tap the hub in order to remove the tapered hub from the spindle shaft.

5. Pull the hub and wheel back and away from the grinder.
6. Ensure the inside of the hub is clean and free from debris. A clean finger works best for this job.

Replacing the Hub on a Grinding Wheel

1. Insert the wheel onto the hub with the product label facing out/up so that the wheel is resting flat against the back shoulder of the hub.



2. While holding the back of the hub, screw the nut onto the hub (again note the left handed threads). Make sure that the “ledge” side of the hub is facing the wheel.



Correct



Incorrect

3. Tighten the hub nut using the spanner wrench.



CAUTION: OVER TIGHTENING THE HUB NUT CAN DAMAGE THE GRINDING WHEEL.

Wheel Balancing



For more information on balancing a wheel, watch our online video, *Surface Grinder Basics: How to Balance a Grinding Wheel* by scanning the QR code or visiting: www.tormach.com/dressgrinderwheel

To eliminate vibration of the grinding wheel during normal operation, the grinding weight should be properly balanced on the wheel hub.

1. To adjust the balance, remove the wheel and hub from the grinder.
2. Thread the wheel hub onto the balancing arbor and secure it in place with the washer and nut included with the accessory kit.



3. Using a level surface and two equally sized resting blocks (1-2-3 blocks work fine for this task), rest the balancing arbor on the plates with the wheel between the plates as shown.

Dressing a Wheel



For more information on dressing a wheel, watch our online video, *Surface Grinder Basics: Grinding Wheel Dressing with an Optical Wheel Dresser* by scanning the QR code or visiting:

www.tormach.com/dressgrinderwheel

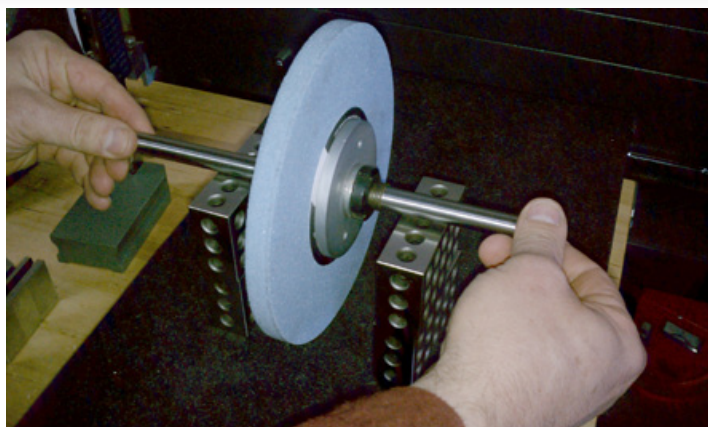

4. Spin the arbor in either direction and set it on the blocks as show in the above photo. When you let go of the arbor, the wheel should remain at rest. If the wheel is not balanced, it will rotate. Repeat this step several times.
5. If necessary, adjust the balancing weights on the inside side of the wheel hub using a flat head screwdriver, moving the weights away from the direction of the "heavy spot."

1. When facing the machine, place the wheel dresser onto the surface grinder magnet with the pointed diamond tip on center.
2. Turn the grinding wheel on in stationary motion and turn the feed and speed knobs full to the left (in the off position) to eliminate table motion.
3. Carefully feed the grinding wheel down onto the diamond using the vertical adjustment handwheel (Z-axis downfeed) until contact is made between the tip and the grinding wheel surface.
4. Turn the table jog handwheel (Y-axis crossfeed) and slowly move the diamond across wheel surface and dress until the wheel achieves the desired finish.

Note: Reference the *Control Modes* section for a definition of the control modes and instructions on switching between modes of operation.



Backlash Adjustment

Over the course of normal operation, the PSG 612 may need backlash adjustment on the Y-axis crossfeed and (less frequently) on the Z-axis downfeed. If you notice lost motion in Y- or Z- adjust the backlash adjustment set screws as follows:

1. Manually move the table in the Y- or Z- direction so that it reaches the edge of travel.
2. Using an Allen wrench, manually tighten both set screws, ensuring the screws are tightened evenly.

Note: The set screws are located to the left and the right of the lead screw as shown:



Set Screw Adjustment on the Y-Axis

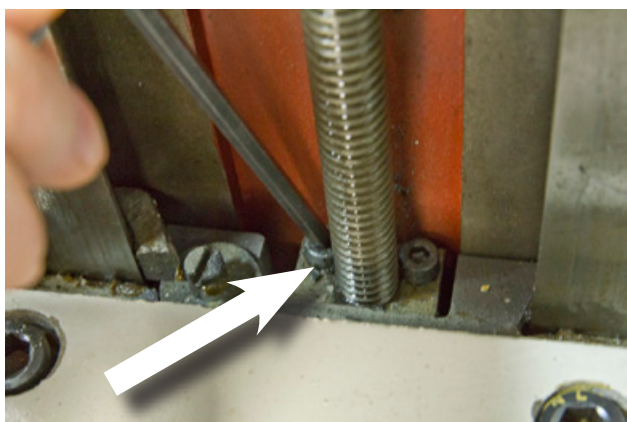

Set Screw Adjustment on the Z-Axis

Gib Screw Adjustment

The slide ways are hand scraped as part of the manufacturing process. This means that the Z axis saddle is fitted to the column. They are scraped in as a set and neither the saddle nor the column can be had as a replacement component. Likewise, the base, XY saddle,

and machine table are scraped in as a set.

The slide ways have tapered gib plates (also hand scraped), where the position of the Gib Plate controls the tightness and friction in a slide way.

Like the backlash adjustment on lead screws, the gib screws on the Y- and Z-axes can loosen over the course of normal operation.

1. If you notice the table is wobbling, manually tighten the gib screw with a flat head screwdriver until you feel resistance as you move the axis.
2. Back off 1/8 turn.



Note: You may want to manually tighten the gib screws before first use, as the grinder may have experienced excess vibration during transit.

Changing/Cleaning Air Filters

1. Remove the entire air filter panel from the side of the control panel.



2. Using a screwdriver, open the front panel cover and remove the air filter.



1. Pull down on the tab at the top of the fuse box.
2. Open the housing and carefully pull the fuse out of the box.
3. Insert a replacement 16A fuse.

Replacing the Y Axis Belt

1. Remove the two cover guard screws.



2. Lift and remove the cover guard.



3. Move the table fully to the left.
4. Remove the five motor cover screws.



3. Wash the air filter with mild soapy water and air dry. Reassemble the panel and place it into position on the control panel.



Replacing Fuse

Note: While 32A is the fuse holder rating, the Tor-mach PSG612 is rated for a 16A fuse. Replacement fuses should be 16A.

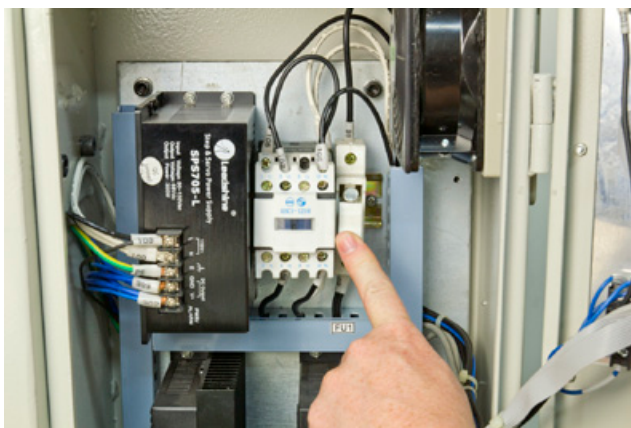

WARNING: UNPLUG THE MACHINE BEFORE REPLACING FUSE.

Machine Storage

If you plan to store the PSG 612 for an extended period of time, it's best to take precautions that protect the equipment from rust and corrosion. Follow these protection guidelines when decommissioning the machine:

1. Disconnect the machine from its power source, taking care to protect the power cord by hanging it from the machine or wrapping it in a location away from damage.
2. If storing the machine for more than a year, completely empty the central lubrication pump and flush all fluid lines.
3. Wipe the surfaces clean, taking care to protect any bare surfaces with a light oil spray or rust inhibiting material such as WD-40.
4. Cover and place the machine in an area that is out of direct sunlight and away from exposure to fumes, dust, dirt, and moisture.
5. If your machine is stored in an area with excessive humidity, consider wiping it down once a month and re-protecting it as described in step 3.
6. You may want to place a moisture-absorbing desiccant pack at the bottom of the electrical cabinet.

5. Remove the motor cover.



6. Using the 5mm Hex wrench included in the tool kit, loosen the four motor mount screws.



7. Slide the motor to the left, relieving belt tension.
8. Remove and replace the Y-axis belt.



9. Repeat steps 1-7 in reverse order.

ELECTRICAL CABINET COMPONENTS

1. C1 Contactor
2. Power Supply
3. Fuse Block
4. Stepper Drives
5. Fan
6. Control Board

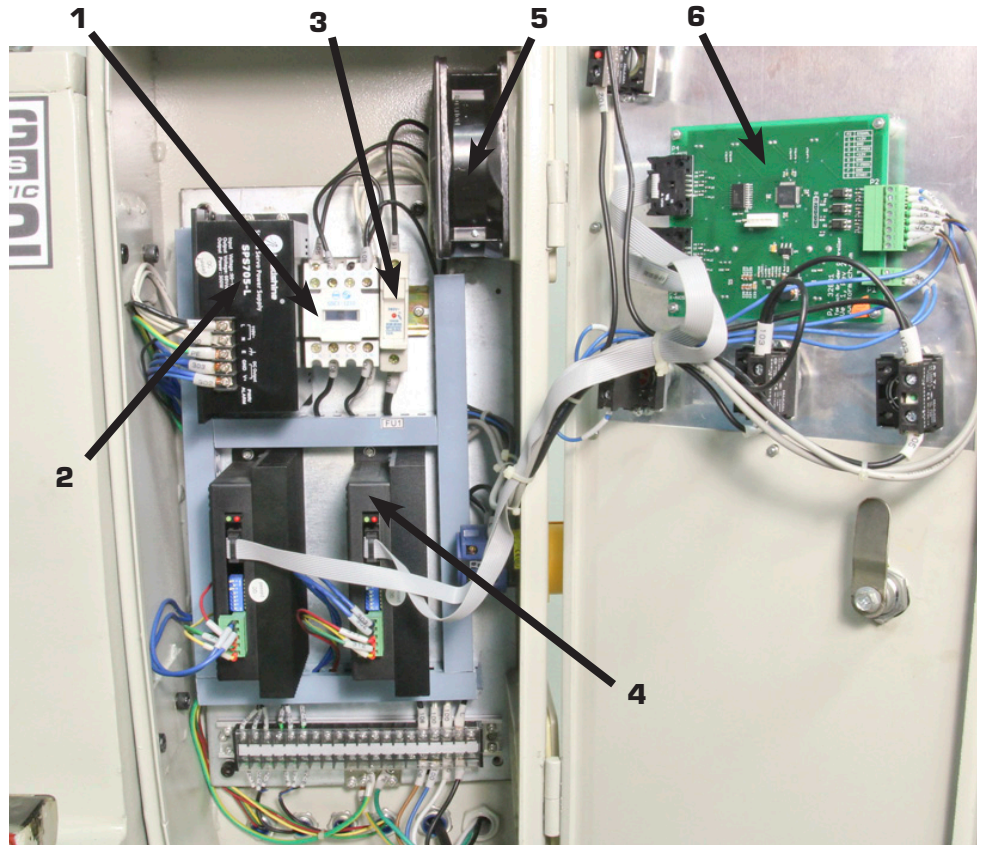

EXPLODED VIEWS

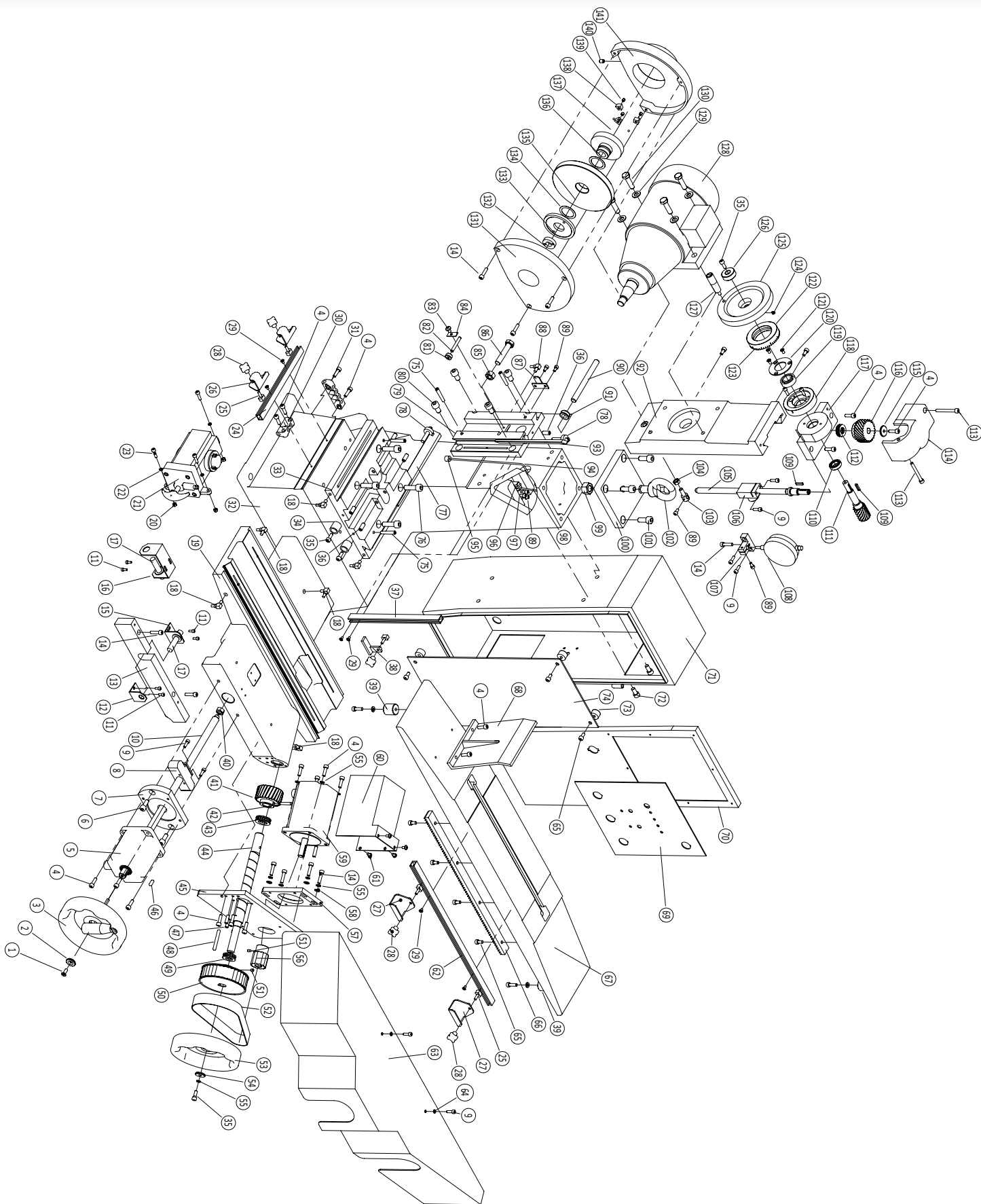

Item	Part Number	Description
1	33933	Screw, SHC
2	33934	Washer
3	33935	Handwheel, Y axis
4	33936	Screw, SHC
5	32809	Motor w/Lead Screw, Y axis
6	33996	Screw, SHC
7	33937	Plate, Motor Mount
8	33938	Nut, Lead Screw
9	33996	Screw, SHC
10	See #5	See #5
11	33996	Screw, SHC
12	33939	Bracket, Cable Guard, X axis
13	33940	Base, Front Guard
14	33996	Screw, SHC
15	33941	Bracket, Sensor, X axis
16	33942	Bracket, Sensor, Y axis
17	33334	Sensor, Proximity
18	33943	Oil Fitting
19	33944	Saddle
20	33945	Nut, 6mm
21	30409	Pump, Manual Oil
22	33947	Washer
23	33996	Screw, SHC
24	33948	Rail, Limit Flag, Y axis
25	33949	Bolt, Limit Flag Retainer
26	33950	Limit Flag, Y axis
27	33951	Limit Flag, X axis
28	33952	Screw, Thumb
29	33953	Screw
30	33954	Manifold, 2 Lines
31	33955	Manifold, 5 Lines
32	33956	Base, Machine
33	33957	Base, Y Axis Dovetail
34	33958	Bumper, Y Axis
35	33996	Screw, SHC
36	33959	Setscrew
37	33960	Rail, Indicator Rest
38	33961	Indicator Rest
39	33962	Bumper, X Axis
40	33963	Nut, Leadscrew Stop
41	33964	Gear, Drive X Axis

Item	Part Number	Description
42	33965	Pin
43	33966	Bearing , Thrust, Inner
44	33967	Shaft, X Axis Drive
45	33968	Plate, X Axis Motor Mount
46	33969	Key, Y Axis Handle
47	33970	Dowel Pin
48	33971	Pin
49	33973	Bearing, Thrust, Outer
50	33277	Pulley, Driven
51	33974	Setscrew
52	33275	Belt, Drive
53	33975	Handwheel, X Axis
54	33976	Washer, Flat
55	33977	Washer, Lock
56	33276	Pulley, Drive
57	33978	Plate, Motor Adjuster
58	33979	Washer
59	33066	Motor, Stepper, X Axis
60	33980	Cover, X Axis Motor
61	33981	Screw
62	33982	Rail, Limit Flag, X Axis
63	33983	Cover, Machine Front
64	33984	Washer
65	33985	Screw
66	33986	Gear Rack, X Axis
67	33987	Table
68	33988	Guard, Deflector
69	33989	Control Panel
70	33990	Door, Electrical Cabinet
71	33991	Cabinet, Electrical
72	33992	Screw
73	33993	Standoff
74	33994	Back Panel
75	33995	Dowel Pin
76	33996	Screw, SHC
77	33997	Gib, Adjustable, Y Axis
78	33998	Screw, Gib
79	33999	Base, Z Axis Dovetail
80	33996	Screw, SHC
81	34000	Pulley, Cable
82	34001	Axle, Pulley

Item	Part Number	Description
83	34002	Screw
84	34003	Retainer, Axle
85	34004	Nut
86	34005	Bolt
87	34006	Stop, Z Axis Travel
88	34007	Fitting Lube, Z Axis
89	34008	Screw
90	34009	Axle, Pulley
91	34010	Pulley
92	34011	Base, Z Axis Handwheel
93	34012	Gib, Adjustable, Z Axis
94	34013	Cable, Weight
95	34014	Cable End
96	34015	Axle, Pulley
97	34016	Pulley
98	34017	Mount, Cable Pulley
99	34018	Nut
100	34019	Plate, Z Axis Top
101	34020	Screw
102	34021	Eyebolt, Lifting
103	34022	Bolt, Cable End
104	34023	Nut
105	34024	Lead Screw, Z Axis
106	34025	Nut, Lead Screw Z Axis
107	33280	Mount, Indicator
108	34026	Dial Indicator
109	34027	Key
110	34028	Bearing
111	34029	Shaft, Geared, Z Axis
112	34030	Bearing
113	34031	Screw
114	34032	Housing, Z Axis Head
115	34033	Washer
116	34034	Gear, Upper Z Axis
117	34035	Housing, Z Axis Handle
118	34036	Housing, Bearing, Z Axis
119	34037	Bearing
120	34038	Cap, Bearing, Z Axis
121	34039	Screw
122	34040	Screw
123	34041	Screw

Item	Part Number	Description
124	34042	Key
125	34043	Handwheel, Z Axis
126	34044	Retainer Z Axis Handwheel
127	34045	Handle, Handwheel, Z Axis
128	33278	Spindle Motor Assembly
129	34046	Washer
130	34047	Bolts
131	34048	Guard, Wheel
132	34049	Nut, Spindle
133	See #136	Hub Nut, Wheel
134	See #136	Washer
135	34050	Grinding Wheel
136	33279	Wheel Hub Assembly
137		
138	34052	Weights, Wheel Balance
139	34053	Screw
140	34054	Screw
141	34055	Housing, Rear Wheel Guard

PSG 612 ELECTRICAL SCHEMATIC JAN. 2014

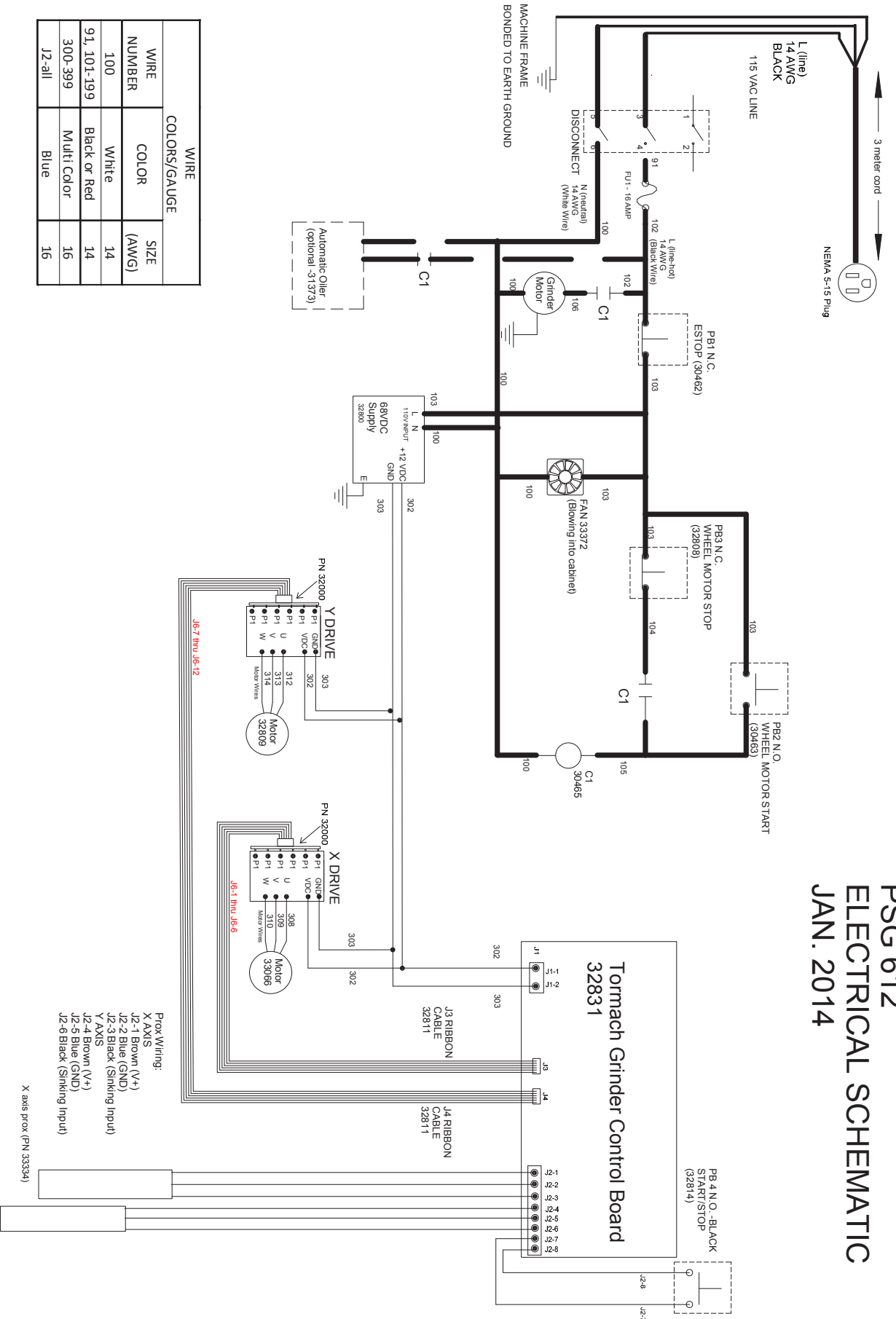

STEPPER MOTOR DRIVERS

PSG 612
DRIVERS AND CABLES
JAN. 2014

X and Y Axis are Three Phase

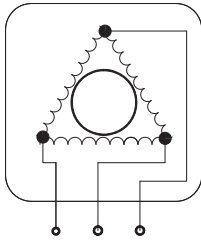

Three Phase Schematic

Connector	Function
P1	PWR GND
P2	VDC
P3	U
P4	V
P5	W

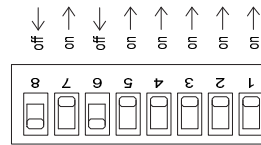

SWITCH SETTINGS FOR
X, Y

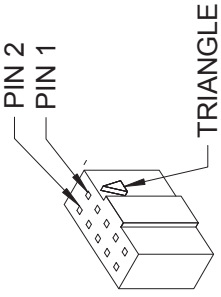

PIN 1 is next to the triangle
Example IDC-10

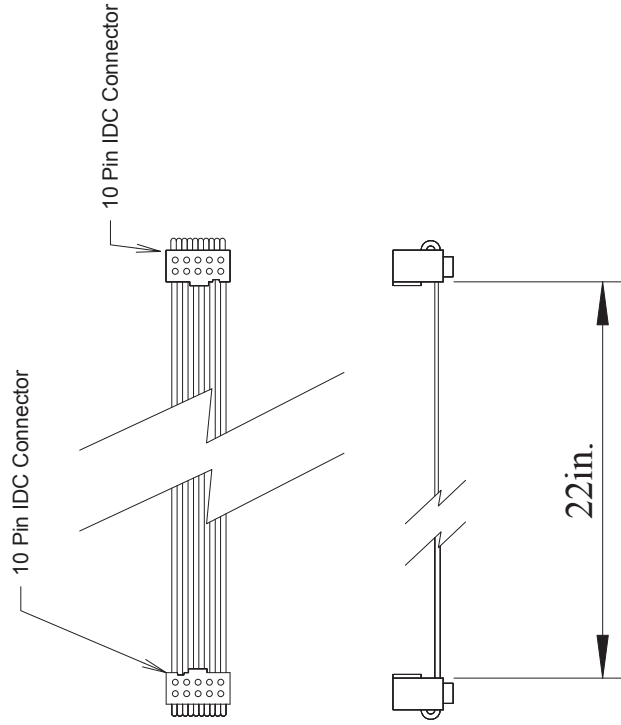

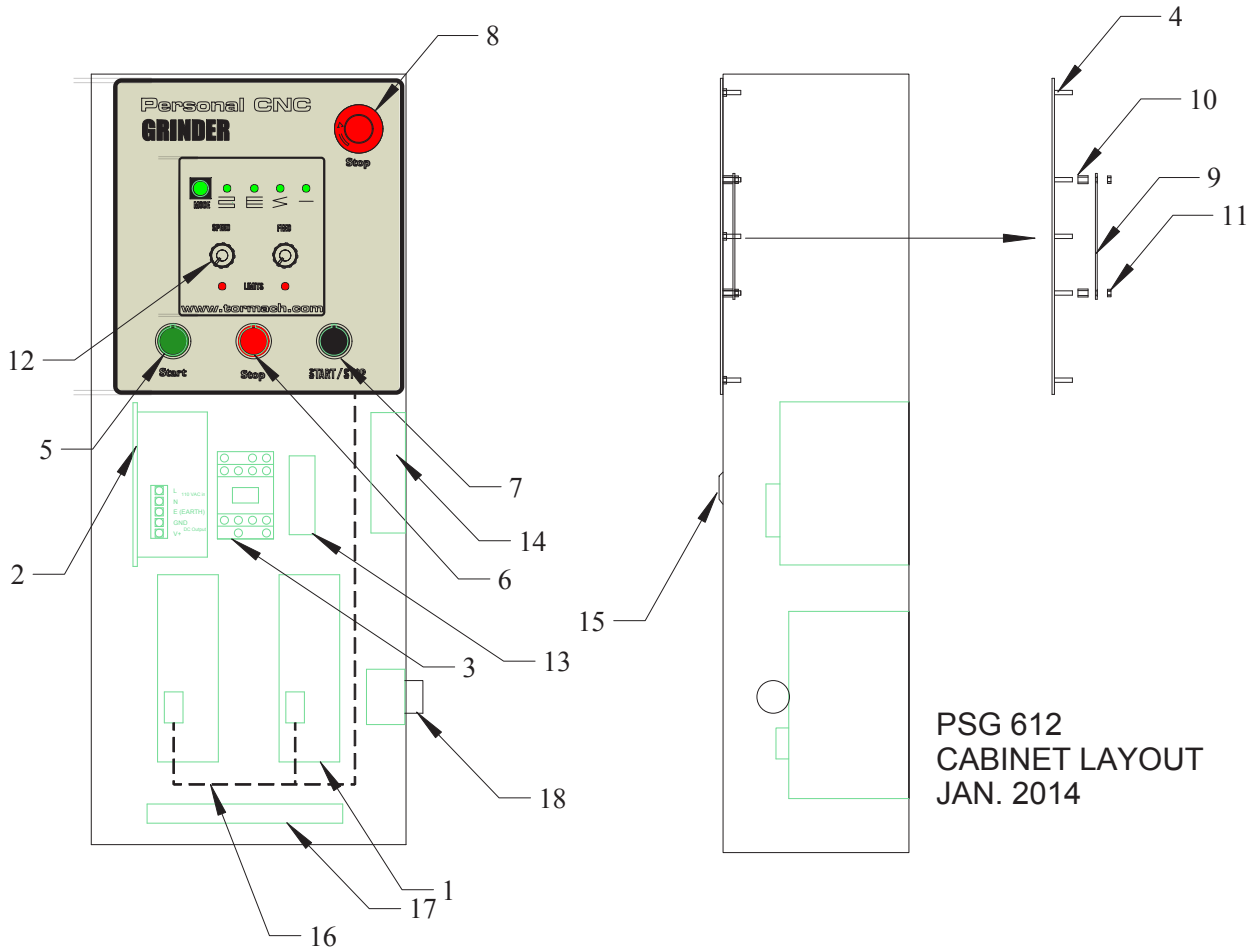

Item	Part Number	Description
1	32000	Stepper Driver (Series 3)
2	32800	68 VDC Power Supply
3	30465	Contactator
4	32815	User Panel
5	30463	Wheel Motor Start Green PB2
6	32808	Wheel Motor Stop Red PB3
7	32814	Cycle Start Black PB4
8	30462	Estop Red-Locking PB1
9	32831	Main Control Board
10	32817	Spacer
11	32818	M3.5 Nut
12	30181	Knob, Adjustment

Item	Part Number	Description
13	30511	Fuse Block
13a	30455	FU1, 16 Amp
14	33372	Fan
15	33373	Cabinet Latch
16	32811	Ribbon Cable, J4
17	34127	Terminal Block
	34128	Terminal Block Jumper
18	30454	Main Disconnect

TROUBLESHOOTING

Table 1: Power Cannot be Turned ON (No Wheel or Table Motion)

Possible Cause	Probability	Action to Identify Cause of Problem	Discussion
Breaker turned off/tripped in the electrical wall cabinet ("breaker box") supplying the PSG 612	High	Check the breaker.	Turn it on if required. If breaker continues to trip, investigate supply line for PSG 612.
Disconnect switch in OFF position	High	Check position of the rotary switch on the right side of the PSG 612 electrical cabinet.	Turn it on if required. Measure for 115 VAC nominal between black and white in/out wires if required to ensure proper switch function.
E-Stop button is pressed	High	Twist the head of the button to release.	
Fuse (FU1) is blown	Low	Measure for 115 VAC nominal between wires 91 and 102.	Turn OFF disconnect switch before checking or replacing all fuses.
E-Stop button is defective	Low	Pull E-Stop out. Measure Voltage between wires 103 and 100; voltage should be nominal 115 VAC if E-Stop is properly functioning.	This test indicates a malfunctioning switch if voltage between wires 102 and 100 measures nominal 115 VAC.

Table 2: X or Y Axis Will Not Move When Commanded

Possible Cause	Probability	Action to Identify Cause of Problem	Discussion
No power to system	High	Refer to Table 1.	
Proximity Switch is triggered	Medium	Make sure neither the X or Y proximity switch is triggering on the metal flags. This will also be indicated when the red LED is lit below the control dial for the appropriate axis.	
DC power supply has failed	Low	First, confirm that nominal voltage into the power Supply is 115 VAC between wires 103 and 100. Measure output voltage between 303 and 302. Output Voltage should measure as 68 VDC.	Replace power supply if input voltage is confirmed at 115 VAC but output voltage does not equal 68 VDC.
Thermal fault on the driver module	Low	Look at the LEDs on the drive. If the red LED is lit, then the drive has tripped.	Cycle power to the machine. This should reset the trip condition. If not, inspect the wiring for shorts or replace the drive.
Failed driver module	Low	Remove power to the system. If the other axis is properly functioning, swap both the ribbon cable and motor/ DC supply wires from the working drive with the suspected failed drive. Return power to the system, and test the function of the opposite axis (now connected to the suspected failed drive).	If the symptoms of have migrated to the other axis, replace the failed drive.

Table 2: X or Y Axis Will Not Move When Commanded

Bad axis motor or motor connection	Low	Power down the system. Remove motor leads from the axis drive.	Simply unplug the green power connector from the board.
		Measure the resistance of the motor windings of the motor, per Table 5.	When making resistance measurements on the motors and other devices with low resistance, always take a tare reading on the meter before doing the resistance measurement in the motor or device.
		If the resistance is out of range, check the wiring carefully for crimps or shorts (including inside the conduit). If the wiring is good and the resistance readings are out of range, the motor has failed.	If unsure about the viability of the wiring, it is best to disconnect the motor leads from the wiring and measure resistance at the motor.
F1 is blown	Low	Inspect F1 fuse on the control board and use a multimeter to verify continuity across the fuse.	If the fuse is damaged, replace the fuse.
Control signals not reaching the driver module	Low	Inspect the ribbon cable running from the control board to the affected axis.	Check connections on both ends for bent or damaged pins. Make sure the connections are firmly seated. Make sure the cable is not kinked or damaged.
Control board is defective	Low	Swap boards.	This is by far the least likely scenario. Thoroughly investigate any other possible options first.
Cycle Start switch is defective	Low	Remove power from system. Turn the Feed and Speed knobs down. Jumper across J2-7 and J2-8 on the control board terminal. Return power to the system.	If table motion is present with the jumper in place, inspect wiring and connections at J2-7 and J2-8. If wiring appears correct, replace the Cycle Start Switch.
Belt is damaged or broken	Low	Remove guarding and inspect belt. If damaged, replace belt.	
X Axis motor coupler is loose/damaged/broken	Low	Remove guarding and inspect the coupler for visible signs of damage. Tighten the coupler if necessary.	Slipping couplers can be easily diagnosed with a witness mark. Using a grease pen or similar, draw a line across the couple and onto the motor shaft and screw shaft. Any slip in the motion will be evident from by a misalignment of the witness mark.

Table 3: Wheel Cannot be Turned on (Automatic Table Motion is Unaffected)

Possible Cause	Probability	Action to Identify Cause of Problem	Discussion
No power to system	High	Refer to Table 1.	
C1 contactor is not energizing/ defective	Low	Measure Voltage across 100 and 105. Voltage should measure nominal 115 VAC. If not, remove power from machine and jumper between 100 and 105. Reconnect power.	If function is restored in presence of jumper, replace C1 contactor.
Defective spindle motor	Low	Measure resistance between motor lead wires 100 and 106. Resistance should be 1.6 Ohms.	
Wheel ON switch is defective	Low	Disconnect power. Jumper between wires 103 and 105. Reconnect power.	If wheel turns on when power is reconnected with jumper install, inspect wiring and switch and replace switch if necessary.
Wheel OFF switch is defective	Low	Disconnect power. Jumper between Wires 103 and 104. Reconnect power.	If wheel turns on when power is reconnected with jumper install, inspect wiring and switch and replace switch if necessary.

Table 4: Counter Weight and Lubrication

Possible Cause	Probability	Action to Identify Cause of Problem	Discussion
Problems with Counter Weight		Cable is off pulley	Reset cable
Problems with Lube		Check valves obstructed	Soak in solvent over night with WD-40 or similar Replace valves
		Pump is damaged	Disconnect line from pump. Verify pump operation
		Oil line is obstructed	Look for kink or obstruction Replace oil line

Table 5 Stepper Motor Winding Resistance

X Axis		Y Axis		Resistance Ω Above Tare*
From (Black Probe)	To (Red Probe)	From (Black Probe)	To (Red Probe)	
308	309 310	312	313 314	0.5-2.0 Ω 0.5-2.0 Ω >1 M Ω
310	309	314	313	0.5-2.0 Ω 1 M Ω
Note, resistance across leads on all phases for X and Y should be about the same. Deviation may indicate a problem.				
All Wires Above	Ground Bar	All Wires Above	Ground Bar	>1 M Ω

WARRANTY

Limited Warranty Coverage

Each Tormach (the “Manufacturer”) PCNC machine (“Machine”) and its components (“Components”) (except those listed below under limits and exclusions) is warranted against defects in material and workmanship for a period of 12 months from the date of delivery. The foregoing is a limited warranty and it is the only warranty by manufacturer. Manufacturer disclaims all other warranties, express or implied, including but not limited to all warranties of merchantability and fitness for a particular purpose.

Repair or Replacement Only

Manufacturer’s liability under this agreement shall be limited to repairing or replacing, at the discretion of manufacturer, parts or components. Shipment for items replaced under warranty is free, but the shipment method is at the discretion of Tormach. In general delivery will be by UPS ground service for domestic customers or USPS for international customers. If overnight or express delivery is requested, additional fees will apply.

Direct sales and phone support is part of the equation that allows us to provide high value at low cost. You must be comfortable with general electrical and mechanical repair concepts, including the appropriate safety procedures, before working on your machine. If you do not have the required skills you will need to find someone locally to assist you. We do not have factory technicians to send to your facility.

Limits and Exclusions of Warranty

Except as provided above, buyer agrees that all warranties express or implied, as to any matter whatsoever, including but not limited to warranties of merchantability and fitness for a particular purpose are excluded. Components subject to wear during normal use and over time such as paint, labels or decals, finish and condition, seals, bellows covers, flex cabling, spindle, etc., are excluded from this warranty. Tormach-specified maintenance procedures must be adhered to in order to maintain this warranty. This warranty is void if the machine is subjected to mishandling, misuse, neglect, accident, improper installation, improper maintenance, or improper operation or application, or if the machine was improperly repaired or serviced. Warranty of general machine tolerances is void if the machine is disassembled or altered by customer.

Without limiting the generality of any of the exclusions or limitations described in other paragraphs, manufacturer’s warranty does not include any warranty that the machine or components will meet buyer’s production specifications or other requirements or that operation of the machine and/or components will be uninterrupted or error-free. Manufacturer assumes no responsibility with respect to the use of the Machine and Components by Buyer, and manufacturer shall not incur any liability to Buyer for any failure in design, production, operation, performance or otherwise of the Machine or components other than repair or replacement of same as set forth in the Limited Warranty above. Manufacturer is not responsible for any damage to parts, machines, business premises or other property of Buyer, or for any other incidental or consequential damages that may be caused by a malfunction of the machine or components.

Limitation of Liability and Damages

Manufacturer is not liable to Buyer, or any customer of buyer for loss of profits, lost data, lost products, loss of revenue, loss of use, cost of down time, business good will, or any other incidental or consequential damage, whether in an action in contract or tort, arising out of or related to the machine or components, other products or services provided by manufacturer or seller, or the failure of parts or products made by using the machine or components, even if manufacturer or seller has been advised of the possibility of such damages. Manufacturer’s liability for damages for any cause whatsoever shall be limited to repair or replacement, at the discretion of manufacturer, of the defective parts, components or machine.

Buyer has accepted this restriction on its right to recover incidental or consequential damages as part of its bargain with Seller. Buyer realizes and acknowledges that the price of the equipment would be higher if Seller or Manufacturer were required to be responsible for incidental or consequential damages, or punitive damages.

This warranty supersedes any and all other agreements, either oral or in writing, between the parties hereto with respect to the warranties, limitations of liability and/or damages regarding the Machine or Components, and contains all of the covenants and agreements between the parties with respect to such warranties, liability limitations and/or damages. Each party to this warranty acknowledges that no representations, inducements, promises, or

agreements, orally or otherwise, have been made by any party, or anyone acting on behalf of any party, which are not embodied herein regarding such warranties, liability limitations and/or damages, and that any agreement, statement, or promise not contained in this warranty shall be not be valid or binding regarding such warranties, liability limitations and damages.

Transferability

This warranty is transferable from the original end-user to another party if the machine is sold via private sale before the end of the warranty period. Should you have a problem with your machine, please consult your operator's manual first. If this does not resolve the problem, contact Tormach through our website at www.tormach.com or call (608) 849-8381.

Extended Warranty

An extended warranty is available for purchase at www.tormach.com or by calling (608) 849-8381.

INDEX

- Adjustment
 - Backscrew—17
 - Gib Screw—17
- Assembly—7
- Balancing Wheel—15
- Care
 - Protecting from Rust—8
- Components—3
- Customer Service
 - Contacting Tormach—2
- Electrical Safety—7
- First Use—12
- Gib Screw Adjustment—17
- Grinding Wheel
 - Changing/Replacing—13
 - Replacing the Hub—15
- Hub
 - Replacing Hub—15
- Installation—8 21
 - First Use
 - Powering up the Machine—12
 - Unpacking and Setup—8
- Lubrication
 - Lubrication Points
 - Central Lubrication Pump
 - Recommended Way Oil—8
- Machine Specifications
 - Product Specifications
 - Size/Footprint
 - Shipping Dimensions—5
- Magnetic Chuck—12
- Maintenance—17
 - Air Filters—17
 - Replacing Y-Axis Belt—18
- Modes of Operation—11
- Operating Safety
 - Basic Machine Safety
 - Best Practices—6
- Product Features—2
- Product Specifications—5
- Ring Test—14
- Spindle Motor Specifications—5
- Storing Machine—19
- Table Flags
 - Adjusting—13
- Tool Box Contents—4
- Troubleshooting—27
- Unpacking—8
- Warranty—30
- Wheel Balancing—15
- Wheel Dressing—16

**Tormach, LLC
1071 Uniek Dr.
Waunakee, WI
53597**