

System documentation FT 3000 :

- Operating instructions FT 3000
- Operating instructions sensor
- Rack 19" description
- Bloc function description
- System configuration
- Connection diagram
- IEC 61508 certificate

Operating Instructions
 377E-63917
 V 4.00 20.12.04

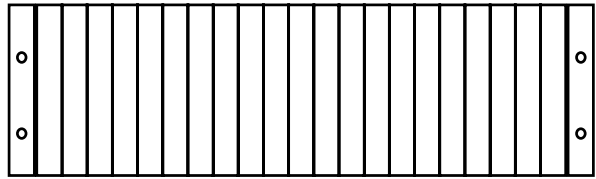

FT 3000

Table of contents

1	THE REDUNDANT OVER SPEED PROTECTION CONCEPT :	5
2	SAFETY WARNING	7
3	APPLICATIONS	7
4	CONSTRUCTION	7
5	FRONT PANEL DESCRIPTION	8
5.1	FTFU 3024	8
5.2	FTV 3090	8
5.3	FTK 3072	9
5.4	FTW 3013	9
5.5	FTBU 3034	10
6	SPECIFICATIONS	11
6.1	STATISTICS	11
6.2	IEC 61508-2-3 SPECIFICATIONS :	11
6.3	TECHNICAL DATA OSPS	11
6.4	TECHNICAL DATA TCCC	16
7	PRINCIPLE OF OPERATION	16
7.1	MEASURING SYSTEM	16
7.2	MEASURING PRINCIPLE	16
7.2.1	<i>Standardising the measured value</i>	16
7.2.2	<i>Speed monitor</i>	16
7.2.3	<i>Frequency measurement (Period measurement principle)</i>	16
7.2.4	<i>Acceleration measurement</i>	19
7.2.5	<i>Limit value control</i>	21
7.2.6	<i>Limit value time control</i>	21
7.3	MONITORING FUNCTIONS	21
7.3.1	<i>Supply</i>	21
7.3.2	<i>Monitoring of internal voltages</i>	21
7.3.3	<i>Sensor monitoring</i>	21
7.3.4	<i>System monitoring</i>	22
7.3.5	<i>Module OK message</i>	22
7.3.6	<i>Fault condition</i>	22
7.4	DIRECTION OF ROTATION DISCRIMINATOR	22
7.5	RELAY CONTROL	22
7.6	TEST FREQUENCY GENERATOR	23

7.7	TEST.....	23
7.8	FREQUENCY OUTPUTS	23
7.9	LAMP TEST.....	24
7.10	MESSAGE ACKNOWLEDGEMENT	24
7.11	BINARY INPUTS	24
7.12	PARAMETER ENTRY	24
7.13	SIGNAL MONITORING.....	24
8	INSTALLATION.....	26
8.1	GENERAL.....	26
8.2	IEC 61508-2-3 SPECIFIC INSTALLATION RULES.....	26
9	SETTING PARAMETERS AND OPERATION	27
9.1	SOFTWARE CONCEPT	27
9.1.1	<i>Process parameter list</i>	27
9.1.2	<i>Configuration parameter list</i>	27
9.1.3	<i>Service parameter list</i>	29
9.2	PC COMMUNICATIONS.....	29
9.2.1	<i>PC system requirements</i>	29
9.2.2	<i>PC software installation</i>	29
9.2.3	<i>Optimisation</i>	30
9.2.4	<i>Setting the display interval</i>	30
9.2.5	<i>Protection of configuration parameters</i>	30
9.2.6	<i>Protection of process parameters</i>	30
9.2.7	<i>Reading and writing parameters</i>	30
9.2.8	<i>Parameter printout</i>	30
9.2.9	<i>Display of current measured data</i>	30
9.3	SETTING PARAMETERS.....	31
9.3.1	<i>System settings</i>	31
9.3.2	<i>Sensor monitor</i>	32
9.3.3	<i>Analog outputs</i>	32
9.3.4	<i>Limit values</i>	32
9.3.5	<i>Test values</i>	33
9.3.6	<i>Parameter enable</i>	33
9.3.7	<i>Password</i>	33
9.4	OPERATING BEHAVIOUR	33
9.4.1	<i>Power up</i>	33
9.4.2	<i>Measurements</i>	34
9.4.3	<i>Response to sensor failure</i>	34
9.4.4	<i>Behaviour during system alarm</i>	34
9.4.5	<i>Response to mains failure</i>	34
9.5	FREQUENCY MEASUREMENT CALIBRATION	34
9.5.1	<i>Calibration tools</i>	35
9.5.2	<i>Factors influencing accuracy</i>	35
9.5.3	<i>Calibration rules</i>	35
9.6	CALIBRATING THE SENSOR MONITOR.....	36
9.6.1	<i>Factors influencing accuracy</i>	36
9.6.2	<i>Calibration rules</i>	36
10	MECHANICAL CONSTRUCTION.....	37
11	CIRCUIT DESCRIPTION.....	39
11.1	FTFU 3024 MOTHERBOARD AND INPUT CARD	39
11.1.1	<i>Frequency measurement</i>	39
11.1.2	<i>Speed monitors</i>	39
11.1.3	<i>Micro controller</i>	39
11.1.4	<i>Supply</i>	39
11.1.5	<i>Reset and non-maskable interrupt (NMI)</i>	40
11.1.6	<i>Input amplifier</i>	40
11.1.7	<i>Sensor monitoring</i>	40
11.1.8	<i>Module monitoring</i>	41
11.1.9	<i>Relay outputs</i>	41

11.1.10	LIMIT LED's.....	41
11.1.11	Frequency generator.....	41
11.1.12	Frequency outputs	41
11.1.13	Binary inputs	41
11.1.14	Test	41
11.1.15	Direction of rotation discriminator.....	42
11.1.16	Lamp test	42
11.2	FTW 3013 - A/D CONVERTER AUXILIARY MODULE.....	42
11.2.1	Supply.....	42
11.2.2	Analog outputs.....	42
11.3	FTV 3090 RELAY CARD	42
11.3.1	Supply.....	42
11.3.2	Relay outputs	42
11.4	FTK 3072 COMMS MODULE	42
11.4.1	Rack bus	42
11.4.2	RS 232 interface.....	43
12	MAINTENANCE.....	44
12.1	PERIODIC TEST.....	44
12.1.1	Description	44
12.1.2	IEC 61508-2-3 specifications.....	44
12.2	TROUBLE SHOTING :.....	45
12.2.1	Procedure for the OSPS	45
12.2.2	Procedure for the TCCC :	46
12.2.3	IEC 61508-2-3 specifications.....	46
12.3	MODULE EXCHANGING :	46
12.3.1	General	46
12.3.2	IEC 61508-2-3 specifications :.....	47
13	STORAGE.....	47
14	WARRANTY.....	47
15	DRAWINGS.....	47

1 The Redundant Over Speed Protection Concept :

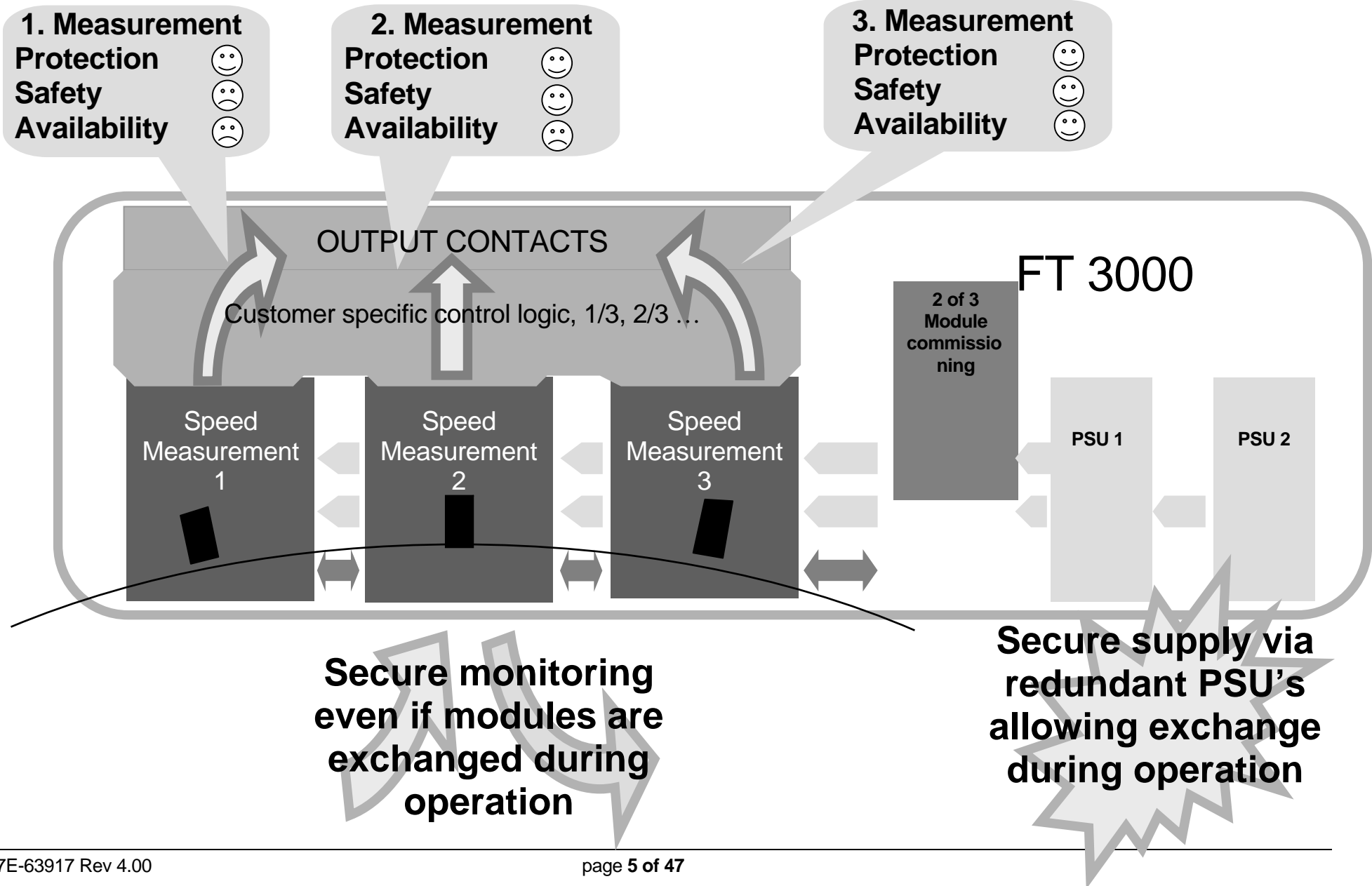



2 Safety Warning

During operation, parts of the FT 3000 are under dangerous voltages. The units conform to protection class 1 and require an earth connection on the corresponding module connector and/or terminal on the 19" rack.

The units have been designed and tested in accordance with IEC 348 and have left the factory in perfect condition.

These operating instructions include information and guidance on the safe operation of the equipment and installation. Please specially note section 6.

If in doubt about the condition of any part following electrical, environmental or mechanical damage, the unit should be returned for repair.

3 Applications

FT 3000 tachometers are used to monitor and measure frequencies in the range 0 to 30000Hz eg from frequency proportional sources such as rotational speed.

The FT 3000 family comprises of the following modules:

- Monitoring module (Motherboard) **FTFU 3024**
- with input card -E01 **FTFU 3024- E01** Art. Nr. 377Z-03981
- with input card -E02 **FTFU 3024- E02** Art. Nr. 377Z-03982
- with input card -E03 **FTFU 3024- E03** Art. Nr. 377Z-03983
- Trip Chain Control card **FTBU 3034** Art. Nr. 377Z-05030

- Frequency to current converter **FTW 3013** Art.Nr.377Z-03984
 (Auxiliary module)
- Relay card (Auxiliary module) **FTV 3090** Art. Nr. 377Z-03985
- Comms module **FTK 3072** Art. Nr. 377Z-03986
- PSU 116/230Vac **FTZ 3061** Art. Nr. 377Z-04065
- PSU 24/48Vac **FTZ 3062** Art. Nr. 377Z-04073
- PSU 14...70Vdc **FTZ 3064** Art. Nr. 377Z-04074
- PSU 75...372Vdc **FTZ 3065** Art. Nr. 377Z-04075
- Mains filter (2 wire) **FTZ 3069** Art. Nr. 804D-35886

FT 3000 3 channel speed monitoring and over speed protection systems comprise of 3 independent channels, from speed pick ups through to limit signalling. High integrity operation is provided for in the rack through the use of 2 redundant power supplies to each module via diode decoupling. Rack module supply requirements are matched to the incoming supply by the 2 redundant power supplies.

4 Construction

The modules are plug in units in a 19" rack, with height 3 HE and with 4, 12 or 20 TE in accordance with DIN 41494.

Compatible card frames with up to 21 locations at 4 TE are used for mounting and wiring the modules. The card frames are built by JAQUET to customer requirements. Connections for speed sensors, control and output signals along with power supplies are normally provided at the back via screw terminals or Termi-Point connections. The setting of measuring range, monitoring and relay parameters is via front panel RS 232 interface on the FTK 3072 comms module to a PC. This module controls the data flow between the PC and individual modules in the rack (RS 485 rack bus). The parameters are stored in EEPROM's and protected against mains failure.

5 Front Panel description

5.1 FTFU 3024

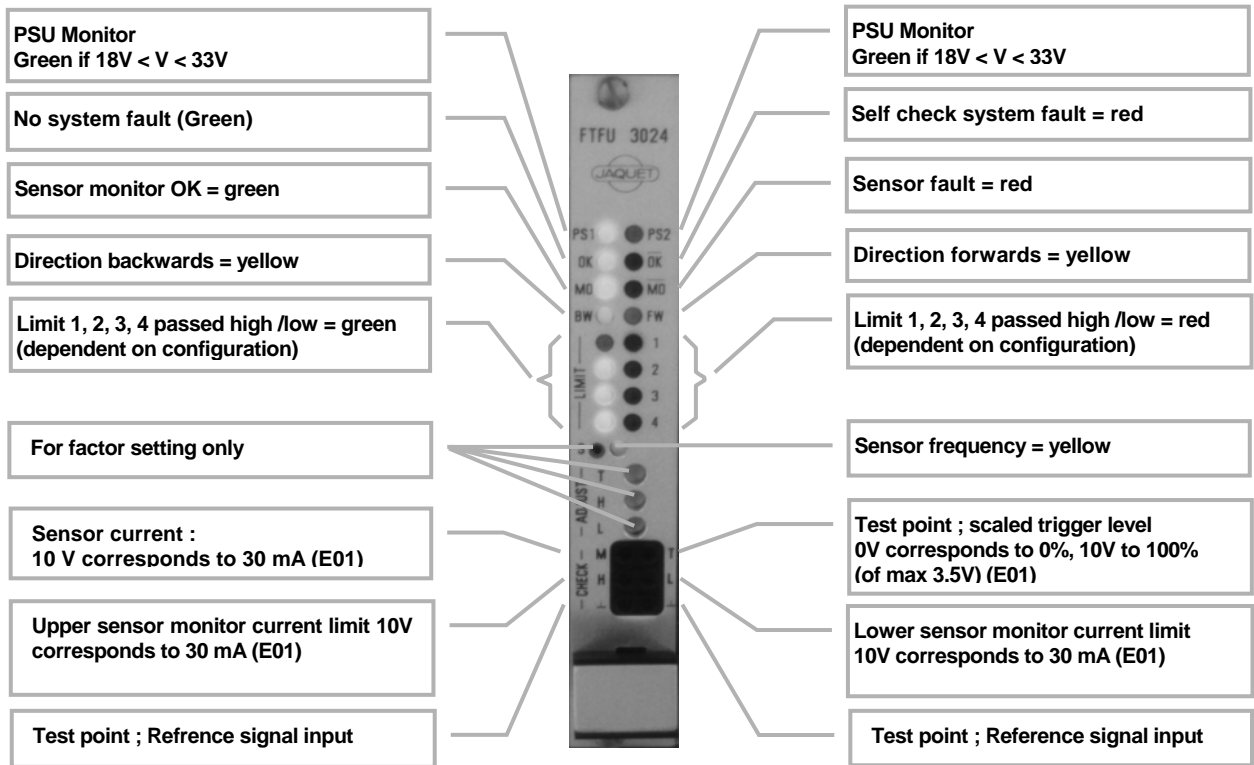

5.2 FTV 3090

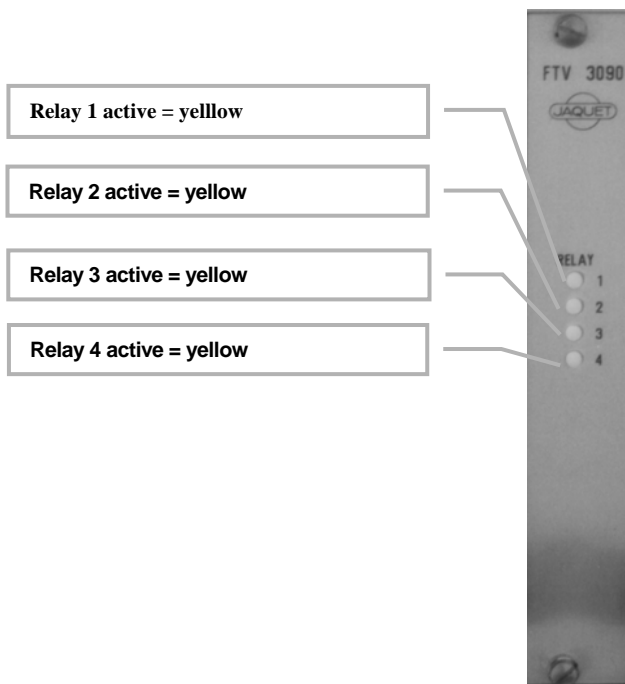

5.3 FTK 3072

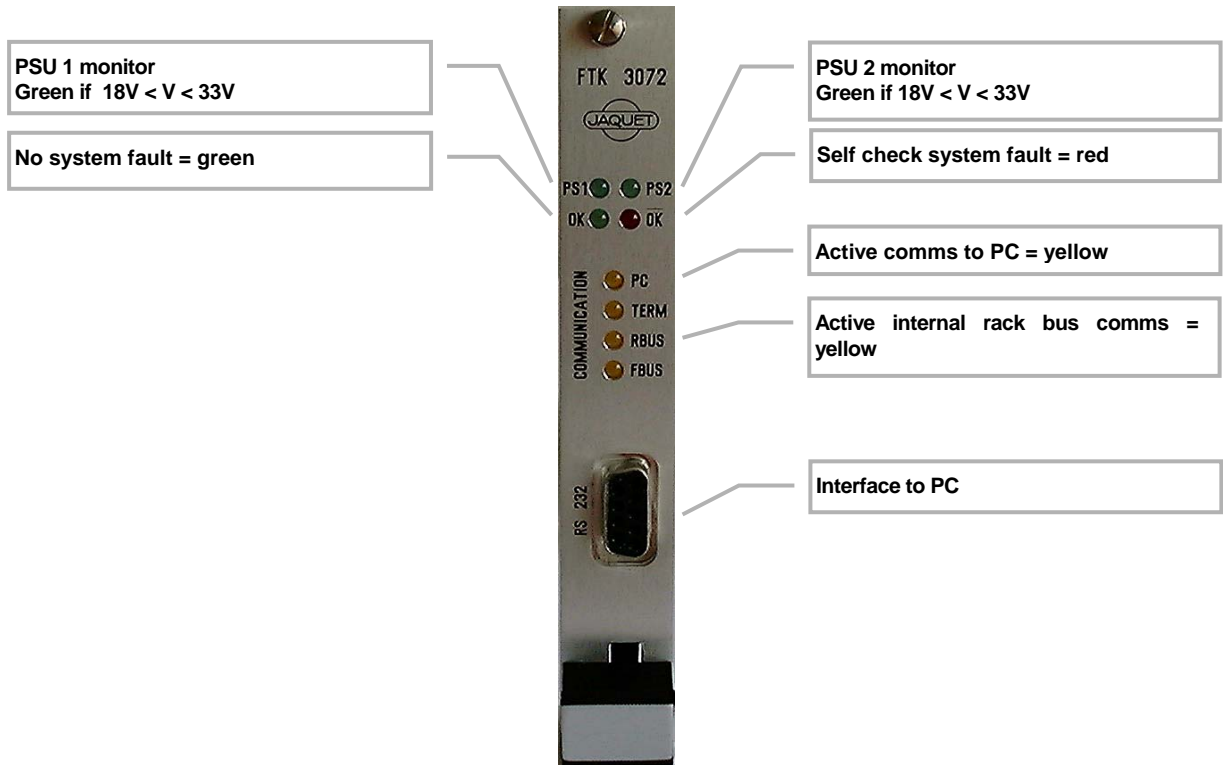

5.4 FTW 3013



5.5 FTBU 3034

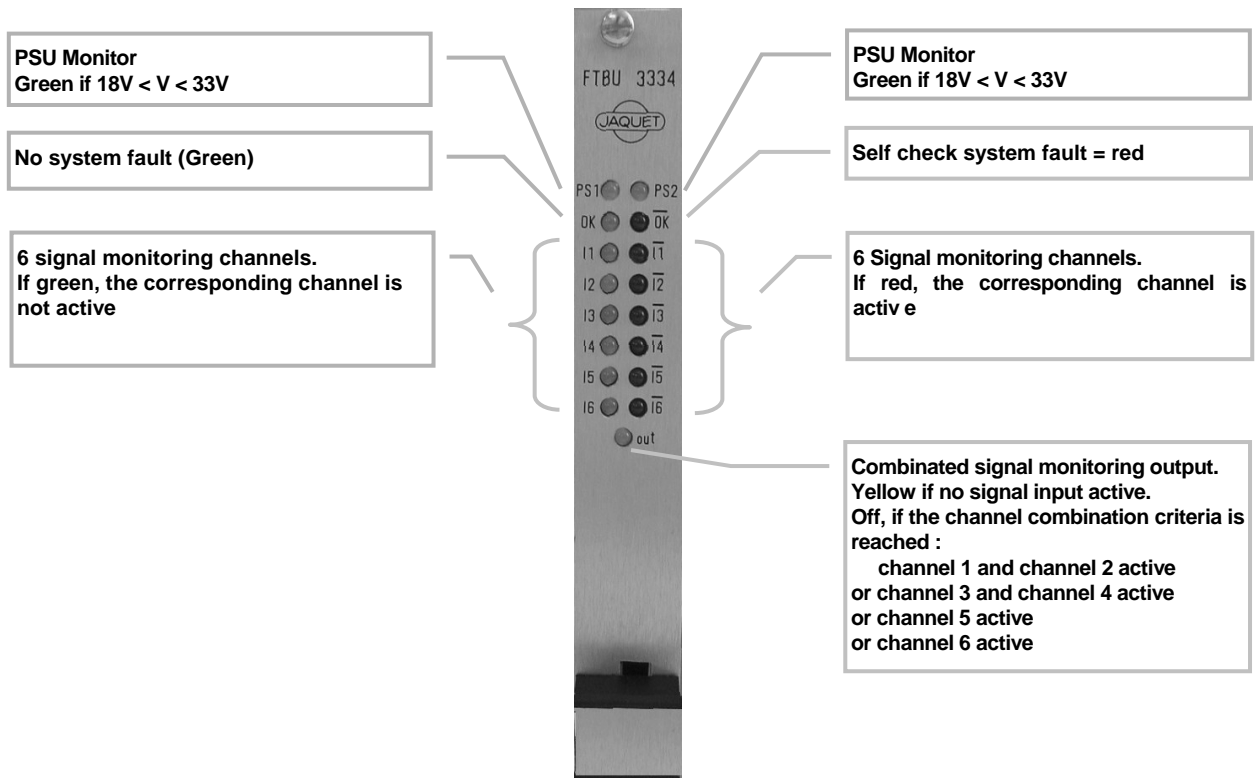

6 Specifications

6.1 Statistics

Mean Time Between Failure for each channel (without voting) : 188683 hours # 21.5 years
 Mean Time Between Failure for each OSP channel (FTFU 3024) : 230700 hours # 26,0 years
 Mean Time Between Failure for each signal monitoring channel (FTBU 3x34) : 1036000 hours # 118 years

PFH_g according to IEC 61508-2 : 2.69e-8 fits
 DC % according to IEC 61508-2 : 94.23%

Life duration for the system is 20 years. During this period the data integrity of the programable devices are granted, this time is equivalent to the MTBF of the channel. After this period the overspeed protection system must be replaced.



6.2 IEC 61508-2-3 specifications :

- System configuration for the Overspeed Protection System :
 The system definition must include for reaching the IEC 61508-2-3 and SIL 3 conformity an alarm signal with following activated selfcontrols for the S + M + P Alarm output :
 - System check : Watchdog, Parameter monitoring, software test
 - Sensor monitoring : Static and/or dynamic sensor monitoring activated
 - Power supply check : monitoring of the supply voltage

In addition, for a safe system behaviour in the case of multiple faults, the system S +M + P Alarm must be combined with the overspeed signal. This means that multiple detected system faults generate a trip. Only 3 channel systems can fulfil the IEC 61508-2-3 requirements.

- System configuration for the optimal additional Trip Chain Control Card.
 Only a 3 channel Trip Chain Control System can fulfil the IEC 61508-2-3 requirements for SIL3. The voted or non voted TCCC signals can be combined with OSPS trip signals.
- System installation :
 The installation specification must be kept for reaching the IEC 61508-2-3 conformity. These specifications must be realised by the system integrator / end user. See chapter Installation.
- System maintenance :
 The maintenance specification must be kept for reaching the IEC 61508-2-3 conformity. These specifications must be realised by the system integrator / the end user. See chapter Maintenance.

6.3 Technical data OSPS

Reference conditions: Operating temperature +20°C
 Supply within defined limits

Smallest measuring range:	0...1.000 Hz
Largest measuring range:	0...35.00 KHz

Once the machine factor M is defined (M = Freq. In Hz/ measured value eg rpm), the input of measuring range and limit values is directly in the chosen physical units eg rpm. In place of the machine factor, the number of pulses per rev from the pole wheel may be entered. Moreover once the nominalspeed is defined (=100%), limits can be given as a percentage of nominal. The measured range may be continuously exceeded up to 55KHz without affecting functionality or causing any damage to the unit.

Sensor signal input- Frequency input 1	Input card -0X for frequency input 1, plugged onto the motherboard FTFU 3024
-------------------------------------------	------------------------------------------------------------------------------

<p>Input card E-01:</p>	<p>potential free, isolation 500V, 50Hz, 1 Min. from electronics and earth ie from front panel and card frames.</p> <p>for connection of electromagnetic, ferrostat or HF sensors, proximity switches and sensors with line amplifiers.</p> <p>Input impedance: 100kohm Input voltage: 50mV...80V rms</p> <p>Bandwith (-3dB) : 0,5 Hz /3.3 kHz Frequency domain for pulsed signals : 0.02Hz / 30kHz Input level for sinus signals : 50 mv rms at min trigger Input level for pulsed signals : 10Vpp at 20% trigger level</p> <p>Trigger level: adjustable between 0 and +3.5V via front panel trimmer T. The voltage at test point T to ground of fixed hysteresis of 50mV rms = 141mVss</p> <p>Integral pull up (+12V) and pull down (0V) resistance of 820 Ohm for connecting 2 wire sensors, jumper selectable.</p> <p>Sensor monitoring of 2 and 3 wire sensors, jumper selectable -If the supply current is < I min or > I max a defect is signalled by the green LED 'MO' off and the red LED 'MO' on. I min is set via front panel trimmer 'L' I max is set via front panel trimmer 'H' A voltage at test points 'L' and 'H' to ground of 0...10V corresponds to supply current of 0...30mA. A voltage of 0...10V at test point 'M' corresponds to the actual supply current of ...30mA. To adjust the trimmers the module must be plugged onto an extension card to open the seal. Integral sensor supply of +11.5...12.5V, max 25mA, short circuit proof (max 40mA).</p>
<p>Input card E-02:</p>	<p>potential free, insulation 500V, 50Hz, 1 Min. from electronics and earth ie from front panel and card frames.</p> <p>This input card is a special version and is only for specific applications available. Configuration available only by contacting the system supplier.</p> <p>Input impedance: 100kohm Input voltage: 0...-24V</p> <p>Frequency domain for pulsed signals : 0... 30kHz Input level for pulsed signals : 0.2 ...24Vpp</p> <p>Trigger level: Adjustable between 0 and +3.5V via front panel trimmer T. The voltage at test point T of 0...10V corresponds to 0...3.5V Trigger Voltage Fixed hysteresis of 50mV rms = 141mVss Default setting : T = 2V corresponds to 660mV Trigger level</p> <p>The sensor monitoring is realised by checking the sensor output signal (Card Uin). Uin (low) must be greater then the defined minimum value (absolut values). Uin (high) must be smaller then de defined maximum value (absolut values). Uin < Uin(min) or Uin > Uin(max) is signaled by the green LED 'MO' off and the red LED 'MO' on. Uin(min) is set via front panel trimmer 'L' Uin(max) is set via front panel trimmer 'H' A voltage at test points 'L' and 'H' to ground of 0...10V corresponds signal level of 0...-24V. Default setting of 'L' = 1V corresponds to a minimum signal level of -2.4V. Default setting of 'H' = 8.33 V corresponds to a maximum signal level of - 19.9V. A square wave signal of 0...10Vpp at test point 'M' corresponds to the actual sensor signal of 0...-24Vpp. To adjust the trimmers the module must be plugged onto an extension card to open the seal.</p> <p>Integral sensor supply of -24V +/- 4%</p>
<p>Frequency inputs 2 and 3</p>	<p>Motherboard FTFU 3024</p>

Operating Instructions FT 3000 JAQUET AG

	For average/max values and direction
2 inputs with common reference voltage - -V of supply	+24 level U low: 0...+3V or open U high: +10...+33V, I source = max 3mA.

Limit values 1 - 4	Motherboard FTFU 3024 with optional relay card FTV 3090 Up to 4 limits for speed or frequency functions
Hysteresis	Upper and lower set points are freely programmable for each limit
Relay function	Monostable function, individually definable as 'Normal' energized in when upper set point exceeded 'Inverse' energized in when speed below lower set point
Relay outputs 1, 2 and 3 on FTFU 3024 motherboard	1 potential free change over contact AC Umax 250V, I _{max} 5A, Pmax 1250VA DC Umax 30V, I _{max} 5A, Pmax 150W Initial breakdown voltage : 1000Vrms 1min. from neighbouring output, electronics and earth, ie from front panel and card frames
Relay outputs 1 - 4 on FTV 3090 relay card	1 potential free change over contact AC Umax 250V, I _{max} 2A, Pmax 125VA DC Umax 220V, I _{max} 2A, Pmax 60W Initial breakdown voltage : 1000Vrms 1min. from neighbouring output, electronics and earth, ie from front panel and card frames
Accuracy	0.1% of the set point
Temperature error	max +/- 50ppm with reference to the set point
Reaction time of speed monitor	Where the limit is assigned to one of the three speed monitors on the motherboard, the minimum measuring time is 1 period of the corresponding set point frequency. The reaction time of the corresponding relay output is Max 1 period of the input frequency + 9ms.
Reaction time of comparaters	Where the limit is assigned to one of the 4 comparators on the motherboard, the minimum measuring time may be set as the Fixed Time. Where the period of the input frequency is shorter than the Fixed Time the relay output reaction time is - Max twice Fixed Time + max input freq. period + 12ms Typically = Fixed Time + 1 input period + 12ms Where the input period is longer than the Fixed Time the reaction time of the relay output is - Max max input period + 12ms
Analog outputs 1, 2 and 3	Auxiliary module FTW 3013 Each of the 3 analog outputs can be used for speed or frequency functions each having independent ranges. The outputs are potential free and isolated to 500V, 50Hz, 1 Min. from each other, the main electronics and earth (neighbouring o/p, front panel and card frame).
Standard configuration	0...20mA or 4...20mA, programmable for rising or falling characteristic Max load 500 Ohm (10V)
Optional version S3	0...5mA or 1...5mA programmable for rising or falling characteristic Max load 2000 Ohm (10V)
Option U, voltage output	0...10V or 2...10V programmable for rising or falling characteristic Max load 7 KOhm (1.4mA)
Max output voltage	30 V
Resolution	12 Bit. 1: 4096
Max linearity error	0.1%

Operating Instructions FT 3000 JAQUET AG

Accuracy	0.2% of the range									
Temperature drift	typically +/- 150ppm/°K, max +/- 300ppm/°K									
Reaction time (step change)	<p>The minimum measuring time may be entered. Where the input period is shorter than the Fixed Time, the reaction time is -</p> <p>Max twice Fixed Time + max input period + 7.5ms Typically Fixed Time + 1 input period + 7.5ms</p> <p>Where the input period is longer than than the Fixed Time, the reaction times is</p> <p>Max input period + 7.5ms</p> <p>Each of the analog outputs can be allocated a software defined low pass filter, whose time constant T can be configured in the range 0.0 to 9.9 seconds. The sample rate is T/10.</p>									
Binary inputs 1 - 6	<p>Motherboard FTFU 3024</p> <p>For programmable control functions such as</p> <ul style="list-style-type: none"> - failure memory reset - max memory reset - initiate lamp test - set direction of rotation - initiate test 									
2 binary inputs (B1 and B2) having common reference -V of the supply	<p>+ 5 V level with pull up resistor</p> <p>V low = active 0...+1V, Isink = max 1mA V high + 3,5...+33V or open</p>									
4 potential free binary inputs (B3...B6) with common floating reference voltage	<p>Isolation 500V, 50Hz, 1 Min. from electronics and earth</p> <p>+24V level</p> <p>V low 0...+5V or open V high = active +10...+33V Isource = max 4mA</p>									
Frequency outputs 1 and 2	Motherboard FTFU 3024									
Frequency output 1 having common 0V with supply	<p>Square wave, amplitude +10V, output impedance 100 Ohm</p> <p>Output current +/-50mA continuous +/- 100mA for 10% of operating time</p>									
Frequency output 2 potential free	<p>Square wave, amplitude +15Vpp, output impedance 100 Ohm</p> <p>Output current +/-50mA continuous +/- 100mA for 10% of operating time</p> <p>Isolation 500V, 50Hz, 1 Min. from electronics and earth</p>									
Frequency generator	<p>Motherboard FTFU 3024</p> <p>Frequency range 0.002Hz / 30KHz. Signal only accessible internally = F4</p>									
Data I/O	Comms module FTK 3072									
Having potential free floating reference	Serial RS 232 interface via front panel D9 connector									
Supply	<p>PSU in the rack for all modules excluding supply modules</p> <p>18...33Vdc</p> <table> <tr> <td>Power consumption</td> <td>Typically</td> <td>Max</td> </tr> <tr> <td>Motherboard FTFU 3024/E01</td> <td>4.5W</td> <td>5.5W</td> </tr> <tr> <td>Converter FTW 3013</td> <td>2.6W</td> <td>2.8W</td> </tr> </table>	Power consumption	Typically	Max	Motherboard FTFU 3024/E01	4.5W	5.5W	Converter FTW 3013	2.6W	2.8W
Power consumption	Typically	Max								
Motherboard FTFU 3024/E01	4.5W	5.5W								
Converter FTW 3013	2.6W	2.8W								

Operating Instructions FT 3000 JAQUET AG

	Relay card FTV 3090 4.0W 4.2W Comms module FTK 3072 2.0W 2.5W
	Power on surge is limited as follows Motherboard FTFU 3024/E01 7A Input cards E01, E02, E03 3.3A Converter FTW 3013 0.1A Relay card FTV 3090 0.1A Comms module FTK 3072 7A
Power Supply	To FTZ 306X Output 24VDC-2A (1.5A for FTZ3061/62, 4A for FTZ3066) Isolation 500V, 50Hz, 1min from earth Isolation 2000V, 50Hz, 1min from input
Model	Voltage max power consumption surge
FTZ 3061	115/230Vac, -20, +15% 63VA 10A
FTZ 3062	24/48Vac, -20, +15% 63VA 50A
FTZ 3064	14...70Vdc 60W 500A
FTZ 3065	88...372Vdc 60W 55A
FTZ 3066	14 ... 70Vdc 120W 500A
FTZ 3069	Mains filter - required if modules supplied direct with 18...33Vdc 66A
Environment	KUE to DIN 40 040 Operating temp 0...+60°C, +70°C for max 2 hours Storage temp -25...+85°C rH 75% yearly average, max 90% over 30 days, condensation to be avoided.
Electromagnetic immunity	Conforms to current european standards
Card frames and modules	Mounting to DIN 41494 Material anodised aluminium Rack space 84 TE - 21 slots each 4 TE Height 3 HE Depth approx 220mm Connectors 2 or 3 row type F to DIN 41612, wire wrap connections as standard to rear screw terminals. Optional Termi Point terminals for direct connection.
Dimensional drawings	Card frames Dwg nr. 3-110.544/4 Modules Dwg nr. 3-110.544/2
Rear screw terminals	Sprung terminals for 2.5mm sq. cable or 1.5mm sq. wire
Protection class to DIN 40050	Card frames IP 10 Plugged modules IP 20 Terminals IP 20
Block diagram	Dwg nr. 4-110.505
Module layout in rack	Dwg nr. 4-110.545
Rack terminal layout/wiring	Dwg nr. 3-110.536
Module connections	
Motherboard FTFU 3024	Dwg nr. 4-110.531/23
Converter FTW 3013	Dwg nr. 4-110.531/24
Relay card FTV 3090	Dwg nr. 4-110.531/25
Comms module FTK 3072	Dwg nr. 4-110.531/26

6.4 Technical data TCCC

TCCC = Trip Chain Control Card, FTBU 3x34

INPUT : IN1 – IN6	6 potential free inputs.
Input voltage for IN1- IN6	20 – 50 V, active level is 0V.
IN1 – IN6 Sink current	Min 10 mA, Max 15 mA
Logical channel combination	The output OUT is active when the following logical combination occurs : IN1.IN2 + IN3.IN4 + IN5 + IN6, where Ini means channel i is active (low level).

INPUT : TEST	The TEST input simulates the logical combination which activates the OUT output. This signal is used for performing periodic FTBU testing.
Input voltage for TEST	5 – 48V, input active level is high. No test mode is at TEST = 0V
TEST Sink current	< 15 mA for the whole voltage range.

OUTPUT : K1 – K6	These relays are the output stage associated with each signal channel. The Relay Ki is energized when INi is high.								
Relay K1 – K6	Potential free change over contact <table style="margin-left: 40px;"> <tr> <td>AC</td> <td>Umax 250V</td> <td>Imax 5A</td> <td>Pmax 1250 VA</td> </tr> <tr> <td>DC</td> <td>Umax 30 V</td> <td>Imax 5A</td> <td>Pmax 150 VA</td> </tr> </table> <p>Initial breakdown voltage : 1000Vrms 1min. from neighbouring output, electronics and earth, ie from front panel and card frames</p>	AC	Umax 250V	Imax 5A	Pmax 1250 VA	DC	Umax 30 V	Imax 5A	Pmax 150 VA
AC	Umax 250V	Imax 5A	Pmax 1250 VA						
DC	Umax 30 V	Imax 5A	Pmax 150 VA						
Reaction time INi to Ki	< 8 ms								

OUTPUT : OUT	This relay is the combined output of the 6 signal channels. The Relay OUT is energized when the logical combination of IN1 – IN6 is not true.								
Relay OUT	2 potential free change over contacts <table style="margin-left: 40px;"> <tr> <td>AC</td> <td>Umax 250V</td> <td>Imax 2A</td> <td>Pmax 125VA</td> </tr> <tr> <td>DC</td> <td>Umax 220V</td> <td>Imax 2A</td> <td>Pmax 60W</td> </tr> </table> <p>Initial breakdown voltage : 1000Vrms 1min. from neighbouring output, electronics and earth, ie from front panel and card frames</p>	AC	Umax 250V	Imax 2A	Pmax 125VA	DC	Umax 220V	Imax 2A	Pmax 60W
AC	Umax 250V	Imax 2A	Pmax 125VA						
DC	Umax 220V	Imax 2A	Pmax 60W						
Reaction time INi to OUT	< 8 ms								

OUTPUT : ALARM	The alarm relay is the output stage of the on board self-diagnostic function. The supply voltage and the logical correlation between input levels and output levels are monitored. The relay is energized when the current card status is no-alarm .								
Relay ALARM	Potential free change over contact, <table style="margin-left: 40px;"> <tr> <td>AC</td> <td>Umax 250V</td> <td>Imax 5A</td> <td>Pmax 1250 VA</td> </tr> <tr> <td>DC</td> <td>Umax 30 V</td> <td>Imax 5A</td> <td>Pmax 150 VA</td> </tr> </table> <p>Initial breakdown voltage : 1000Vrms 1min. from neighbouring output, electronics and earth,</p>	AC	Umax 250V	Imax 5A	Pmax 1250 VA	DC	Umax 30 V	Imax 5A	Pmax 150 VA
AC	Umax 250V	Imax 5A	Pmax 1250 VA						
DC	Umax 30 V	Imax 5A	Pmax 150 VA						

	ie from front panel and card frames
Power Supply	The card FTBU 3x34 can be used with standard FT3000 redundant power supply units. Both voltages are combined on the card and the supply voltages are monitored.
Supply voltage	18 ... 33V
Supply current	Typ : 160 mA Max 250 mA at 24V
Power on surges	Limited at 1 A

7 Principle of operation

7.1 Measuring system

The measuring system on the FTU 3024 motherboard processes four frequencies, F1, F2, F3, F4. Input F1 is derived from the amplified sensor signal from the input card EOX. Inputs F2 and F3 are derived from the outputs of additional FTFU 3024's present in a 3 channel system. Input F4 is derived from the test frequency generator.

7.2 Measuring principle

7.2.1 Standardising the measured value

Following input of the machine factor $M = f/n$, where f = sensor frequency in Hz for a known speed and n = machine speed in rpm

or input of the number of pulses per rev (nr. of pole wheel teeth), the frequency relay limit values and the converter measuring ranges can be directly entered in rpm.

The relationship between the sensor signal frequency f and the speed n of a pole wheel to be sensed is

$$f = n * p/60 \quad \text{where} \quad \begin{array}{l} f = \text{sensor frequency in Hz} \\ n = \text{pole wheel speed in rpm} \\ p = \text{nr. of pole wheel teeth} \end{array}$$

For rotational speed measurements the machine factor $M = p/60$.

In place of speed n in the formulae above, any other frequency proportional physical unit may be used.

If the limit values and measuring ranges are to be entered in percent of nominal, the above calculations are still required.

7.2.2 Speed monitor

The max 3 speed monitors are based on hardware re-triggerable One Shot circuits that are set with every positive edge of the input frequency. The timebases are derived from 3 down counters that are set with the set point frequency and clocked down using a 2.5MHz reference signal. If the counter reaches zero before the arrival of the next positive edge, this indicates that the input frequency is lower than the set point. These functions for one limit value are performed in an ASIC (Application Specific IC). The preset values for the down counter are computed by a microprocessor for the required set point and loaded into the ASIC.

The 3 speed monitors continuously collect speed frequency data without interruption.

Each speed monitor is supplied with 1 of 5 possible input signals, defined by software configuration (None, F1, F2, F3, F4)

7.2.3 Frequency measurement (Period measurement principle)

FT 3000 tachometers work on the continuous period measurement principle. The measuring chains for 3 frequency measurements are implemented in hardware using ASIC's. Each of the 3 ASIC's contain a counter to measure the period duration of up to 3 frequencies. The mpu reads the counter's status with each positive edge of the input frequency. The difference between the status of 2 counters is a measure of the period of the input signal. The frequency

data is continuously collected from all 3 measuring chains without pause. The number of periods measured is determined by the Fixed Time and the magnitude of the input frequency.

The measured value (rotational speed) is then computed by the mpu. There are then 3 floating point values available - <AbsolutA>, <AbsolutB> and <AbsolutC>.

Each measuring chain is supplied with 1 of 5 possible input signals, defined by software configuration (None, F1, F2, F3, F4).

7.2.3.1 Measurement functions

Based on the measured values <AbsolutA>, <AbsolutB> and <AbsolutC>, the following functions can be realised: <FunctionOutput>

- Majority value of A, B and C: From the 3 values 2 are selected that display the smallest difference and used to generate an average value.
- Max value of A, B and C: The max value is selected from the 3
- Min value of A, B and C: The min value is selected from the 3
- Average of A+B+C
- Average of A+B
- Average of B+C
- Average of C+A
- Difference A-B
- Difference B-C
- Difference C-A
- Ratio A/B
- Acceleration 1 (Accel. 1) :
$$\text{Accel}_1 = (\text{speed}_2 - \text{speed}_1) / (\text{time}_2 - \text{time}_1) \quad (\text{RPM/s})$$
- Acceleration 2 (Accel. 2) :
$$\text{Accel}_2 = \text{Accel}_1 / \text{speed}_1 \quad (\text{RPM/s})$$

Accel₂ units could also be %/s, this means that we are speaking here of a rate of change from the nominal speed.

The function is defined by software configuration.

7.2.3.2 Max value memory

The max value memory <MaxMem> registers the maximum value of a measurement (Drag pointer function)

The max value memory can only be reset via an intentional entry *ResetMaxMem* in the *CommandByte* or through total power failure. Which measured value is stored is defined by the software configuration -

- <AbsolutA>
- <AbsolutB>
- <AbsolutC>
- <FunctionOutput>

Always remember to reset the Max value memory following testing with internal generators. Speed measurement and over speed trip monitors are separate functions within the FT 3000.

In operation, there are 2 main reasons why the recorded Max value may not correspond to the limit setting:

- the trip point is reached but the machine runs on until the shutdown valve has closed. The maximum speed the machine reached prior to shutdown is therefore recorded.

- gear machining inaccuracies, coupled with a low number of pulses configured for the trip setting may result in the over speed monitor activating the trip relay at a speed apparently lower than the limit set. The solution to this is to increase the number of pulses used to say 20% of the number of teeth on the gear

7.2.3.3 Comparators

Each of the 4 comparators can be allocated one value from the following list by software configuration -

- <AbsolutA>
- <AbsolutB>
- <AbsolutC>
- <FunctionOutput>
- <MaxMem>

A comparator compares the actual measured value with the predefined set point and establishes limit status (upper/lower limit reached)

7.2.3.4 Analog outputs

Each of the 3 analog outputs from the FTW 3013 can be allocated one measured value via software. The start and end values for each range can be independently defined. Rising and falling characteristics are permissible. Each analog output may include a low pass filter with software configurable time constant.

7.2.4 Acceleration measurement

The acceleration is measured with the speed measurement unit implemented in hardware (FPGA). The measurement of the speed is made every 10 ms (for speeds greater than 100 RPM). The precision of this measurement is determined by the clock of the „time counter“, which is 2.5 Mhz. Here we consider that this clock has no jitter, what is true due to the integration of the jitter during the measurement

The relative measurement accuracy of the acceleration is defined by :

$$\frac{\Delta acceleration}{acceleration} (\%) = 0.8 * \frac{speed(RPM)}{acceleration(RPM / s)}$$

For example :

Speed = 3000 RPM

Acceleration = 1200 RPM (rate of change of 40% per second)

The reachable accuracy is +/- 2% for the acceleration.

FT3000 acceleration measurement error

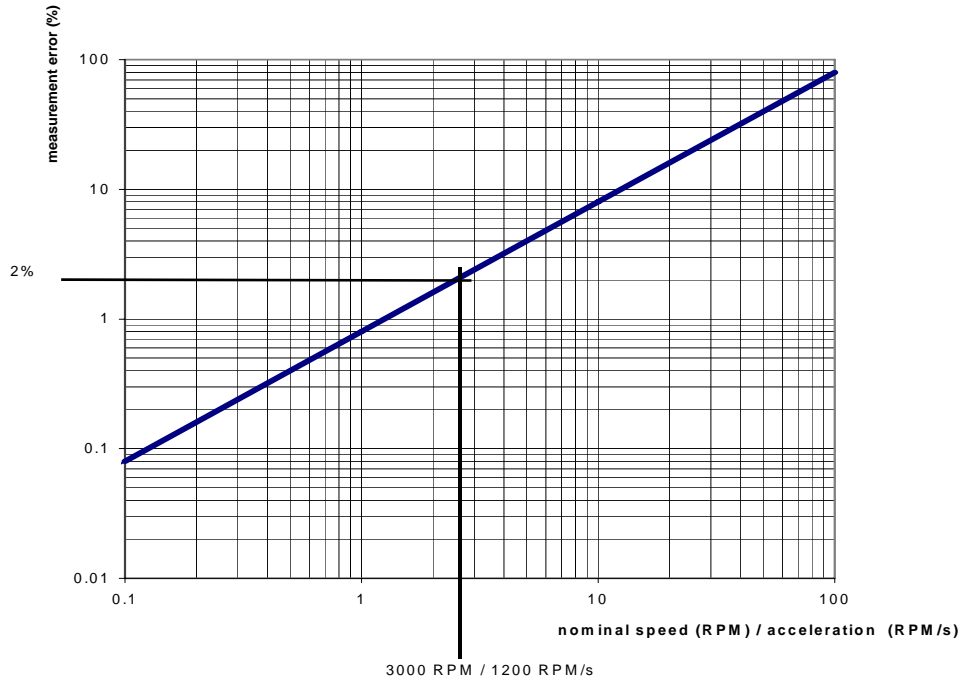

7.2.5 Limit value control

There are 4 limit values available. There are independent upper and lower set points for each so that almost any hysteresis is possible.

Limit1, Limit2 and Limit3 may be assigned to either speed monitor 1, speed monitor 2, speed monitor 3, comparator 1, comparator 2 or comparator 3 via software configuration.

Limit4 is permanently assigned to comparator 4.

Limit status is displayed on the FTFU 3024 front panel via 4 green and 4 red LED's. The active limit colour can be defined by software configuration.

The operation of the limit can be defined by software configuration to be *normal* or *inverse*.

One relay from the FTFU 3024 and the FTV 3090 can be assigned to a limit value.

The status of the relay in failure mode (energized, deenergized) can be defined by software configuration (table)

7.2.6 Limit value time control

Time control for the first 3 limit values can be defined by software configuration.

7.3 Monitoring functions

7.3.1 Supply

The FTFU 3024 and the comms module FTK 3072 are supplied with +24Vdc from 2 redundant PSU's, PS1 and PS2. The 2 supplies are separately fused and diode decoupled.

The microprocessor's A/D converter monitors the supply tolerance after the fuse. Both front panel green LED's only light when their corresponding supplies are within tolerance of 18...33V. The internal messages *PS1OK* and *PS2OK* are set (=1) in the status byte when the supplies are within tolerance, reset (=0) when not.

PSOK is an AND function of *PS1OK* and *PS2OK* and is available for relay control. The constituents of the AND function can be masked by software configuration. When not otherwise specified, relay K1 on the FTFU 3024 signals *PSOK*.

7.3.2 Monitoring of internal voltages

The voltages before and after the +5V regulator are monitored on the FTFU 3024 and FTK 3072.

If out of tolerance a non maskable interrupt is sent to the mpu.

7.3.3 Sensor monitoring

The FTFU 3024 carries out background tests on the correct operation of the sensor.

- Static monitoring is via measurement of the sensor's current consumption. When the consumption is in the permitted range, *StaticMonitorOK* is set (=1) in the Status byte, otherwise reset (=0).
- Dynamic 2 out of 3 monitoring determines the deviation between measured values <AbsolutA>, <AbsolutB> and <AbsolutC> in comparison with a user definable max deviation. *DynAOK*, is set (=1) in the status byte when the deviation of the corresponding measured value is within defined limits, otherwise reset (=0).
- Dynamic 3 out of 3 monitoring works like Dynamic 2 out of 3 monitoring when the three measured values are above max deviation. When they are under max deviation the 3 measured values must be equal, otherwise *DynAOK*, *DynBOK* and *DynCOK* will be reset (=0).
- Combination of static and dynamic monitoring. *SensorMonitorOK* in the status byte is an AND function of *StaticMonitorOK* and *DynAOK* and is available for relay control. The constituents of *SensorMonitorOK* can be masked by software. When not otherwise defined, relay K2 on the FTFU 3024 is used to signal sensor monitoring. In the event of a fault (*SensorMonitorOK* = 0) the front panel green MO-LED goes out and the red NMO-LED lights

7.3.4 System monitoring

The FTFU 3024 and FTK 3072 run background self tests on the most important CPU and EEPROM functions. *SelftestOK* is set (=1) when no fault exists, otherwise reset (=0).

SystemOK in the status byte is an AND function of *SelftestOK*, *SensorMonitorOK* and *PSOK*. The constituents of *SystemOK* can be masked by software configuration. In the event of a fault (*SystemOK* = 0), the front panel green OK-LED goes out and NOK-LED lights.

During tests of an otherwise fault free measuring chain, the green OK-LED blinks.

All relay and analog output behaviour in the event of a system fault is described in paragraph 7.4.4.

7.3.5 Module OK message

ModulOK in the status byte is an AND function of *SelfTestOK*, *SensorMonitorOK* and *PSOK* and is available for relay control. The constituents can be masked by software.

7.3.6 Fault condition

CmdOnFailure in the status byte is an AND function of *SelfTestOK*, *PS1OK*, *PS2OK*, *PS1OK-OR-PS2OK* and *SensorMonitorOK*. The constituents can be masked by software configuration. In the event of a fault (*CmdFailure* = 0), the limit values assume the condition defined in the parameter table for limit value control (influence on LED's and relay control)

7.4 Direction of rotation discriminator

To establish direction of rotation, 2 or 3 suitable speed sensors can be positioned around a pole wheel such that their output signals are electrically phase shifted by 90 or 120 degrees. The sequence of signals then changes with pole wheel direction.

An analysis of the signal phase relationships allows the direction to be determined. The required logic is on the FTFU 3024 in the ASIC's. The direction is displayed on the front panel yellow LED's FW (ForWard) and BW (BackWard). *BW* and *FW* in the status byte are available for relay control.

When 2 signals are present (S1 and S2 or S2 and S3 or S3 and S1), forward operation (FW on) is defined as S1 leading S2 or S2 leading S3 or S3 leading S1.

When 3 signals are present (S1, S2 and S3), forward operation (FW on) is defined as S1 leading S2 **and** S2 leading S3 and S3 leading S1.

The use of 3 sensors **instead of 2** provides greater security against sensor failure since the internal logic provides correct discrimination even if one sensor fails.

The required **direction display for a given phase relationship** can be defined in the configuration. Direction can also be signalled via a relay.

Setting forward operation is via the corresponding binary input configured. Forward operation is then assumed and the relay adopts the corresponding status.

The **direction display following power up** can be defined by software.

7.5 Relay control

Each of the 3 relays on the FTFU 3024 and 4 on the FTV 3090 can be assigned to one function from the following list. The selection is defined by software:

- Limit value
- *ModulOK*
- *PSOK*
- *SensorMonitorOK*
- *FW*
- *BW*

- *TestO*
- *PS1OK*
- *PS2OK*
- *Limit 1*
- *Limit 2*
- *CmdOnFailure*
- *FW Inverse*
- *BW Inverse)*
- *ON*
- *OFF*
- *Limit3*
- *Limit4*

7.6 Test frequency generator

ASIC 3 (measurement channel C) on the FTFTU 3024 includes a frequency generator for test purposes, having 2 selectable frequencies. The output signal from the generator is taken to input F4 and can be routed to inputs F1, F2 or F3 on the speed monitor. The 2 frequencies are automatically derived from the predetermined parameters *upper test value* and *lower test value* (eg in rpm).

7.7 Test

Each of the 3 speed monitors can be allocated 2 configurable parameters, *upper test value* and *lower test value*. 2 internal commands in the *CommandByte*, *SpeedMonitorInputASelect* and *SpeedMonitorInputBSelect* enable selection of one of the 3 speed monitors as follows:

<i>SpeedMonitorInputBSelect</i>	<i>SpeedMonitorInputASelect</i>	Selected monitor
inactive	inactive	None - no test
inactive	active	Speed monitor 1
active	inactive	Speed monitor 2
active	active	Speed monitor 3

When *UnderOverSelect* in the *CommandByte* is set active (=1), the *upper test value* is selected, when reset inactive (=0), the lower. The command *TestOn* in the *CommandByte* then switches the test frequency to the chosen speed monitor.

With *TestOn* set active (=1) the test starts, with *TestOn* reset inactive (=0) testing is terminated.

During testing the green LED OK flashes at 1Hz and *TestOn* is set active (=1) in the *StatusByte* and is available for relay control.

Testing is only possible if there is no system fault, a speed monitor has been selected and *TestOn* is set active.

The status of internal commands *SpeedMonitorInputASelect*, *SpeedMonitorInputBSelect*, *UnderOverSelect* and *TestOn* can be changed via configured binary inputs or FT 3000 PC commands.

7.8 Frequency outputs

3 frequency outputs are available.

Frequency output 1 having common reference voltage with -V on the supply.

Frequency output 2 having potential free, floating reference.

Frequency output 3 controls the yellow front panel LED S.

Every frequency output is programmable with one of 5 possible input signals (None, F1, F2, F3, F4).

7.9 Lamp test

The lamp test switches on all FTFU 3024 and any FTV 3090 LED's present. No relay status is changed.

Relays remain under the sole control of the monitoring module.

Lamp testing is active when *LampTest* is set active (=1) in the *CommandByte*.

7.10 Message acknowledgement

Whether the internal messages *PS1OK*, *PS2OK*, *SensorMonitorOK* and *ModulOK* must be acknowledged or not can be defined by software. Acknowledgement is via setting (=1) and resetting (=0) of *ResetLatch* in the *CommandByte*.

7.11 Binary inputs

Each of the 6 binary inputs can be allocated to one of the following functions:

- without None
- Reset messages via active hold function *ResetLatch*
- Reset max value memory *ResetMaxMem*
- Lamp test *LampTest*
- Set direction *DirectionSet*
- Select speed monitor to test *SpeedMonitorASelect*
- Select speed monitor to test *SpeedMonitorBSelect*
- Select 1 of 2 test frequencies *UnderOverSelect*
- Initiate test *TestOn*

An inactive binary input resets (=0) the allocated internal command.

An active binary input sets (=1) the allocated command.

7.12 Parameter entry

The input of **process** and **configuration** parameters would normally be made by the manufacturer or OEM per the order. **Process** and **configuration** parameters are configurable via PC software using the RS 232 interface and the FTK 3072 comms module (see section 7).

Where a micro terminal is installed, process parameters may be entered via this.

Service parameters are reserved for the manufacturer.

All parameters are stored in EEPROM and not lost if power fails.

7.13 Signal Monitoring

Operating Instructions FT 3000 JAQUET AG

The FTBU card is designed to combine different trip commands to provide global shutdown control within the IEC 61508 SIL 3 regime. The overspeed functionality of the FT3000 is SIL 3 certified. The FTBU extends this certification to encompass trip signals from other sources such as temperature, pressure etc alarms.

6 potential free change-over relay contacts (K1-6) are created from 6 opto-coupled inputs (IN1-6). The relationship between IN_i and K_i is 1:1. An additional output (OUT) comprises of two relays that each provide a change-over contact. These contacts allow 2 out of 3 voting in a three FTBU 3x34 card system. The OUT output is driven by a logical combination of the six inputs : OUT is active (deenergized) when the following equation is true :

$$IN1.IN2 + IN3.IN4 + IN5 + IN6$$

where IN_i means an active input (low level).

This function allows the FTBU card to provide optimum combination of commands in the trip chain and simplify system wiring.

The card has an on board self-diagnostic unit, which drives the ALARM output. The power supply and the logical correlation between the 6 inputs and the relay outputs are monitored. Spare contacts from the OUT relays are used for this purpose.

To periodically check the availability of the trip chain function a test input allows simulation of the OUT relays. The relay function must then checked by the user.

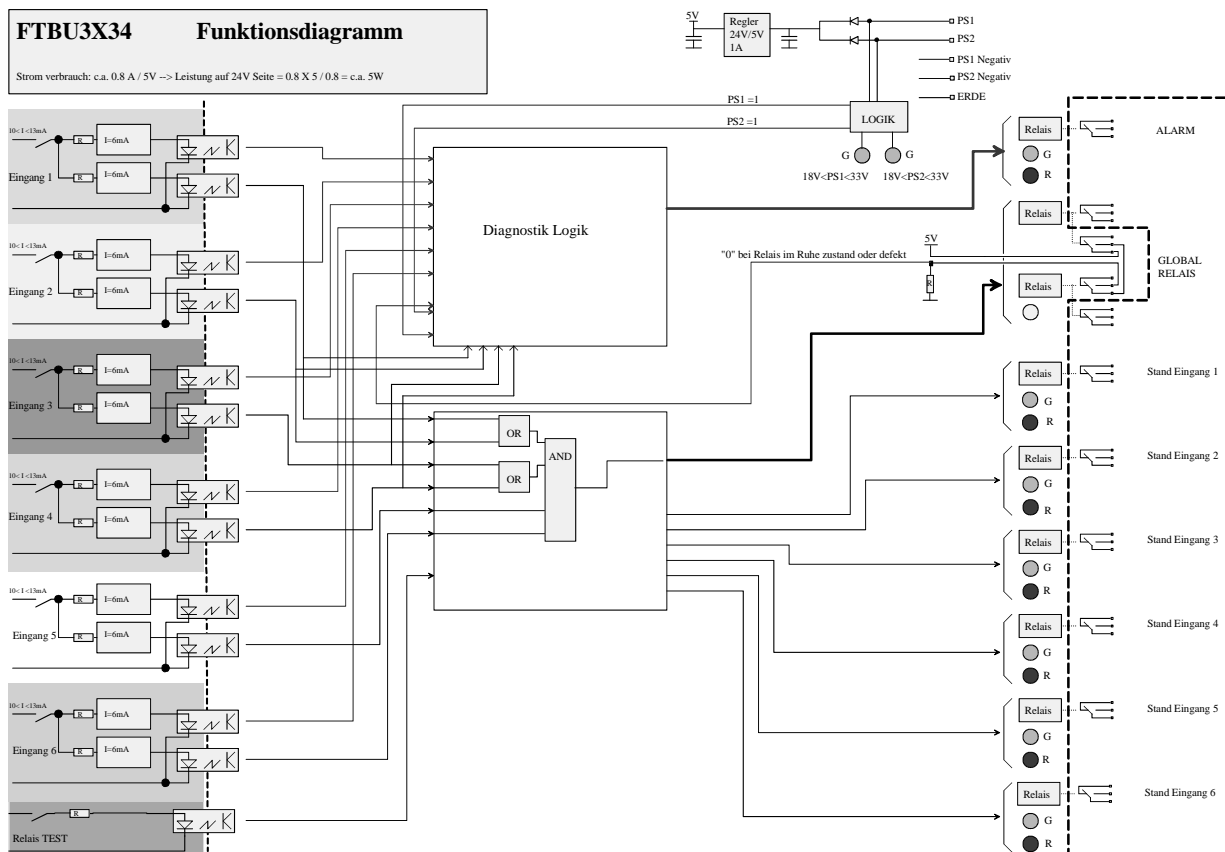

8 Installation

8.1 General

The equipment conforms to protection class 1 and requires the connection of protective earth.

This must be connected to the designated terminal **before** any other connections are made. The earth wire cross section must be at least the same size as the power cables.

NB: Any interruption of the earth connection outside or inside of the equipment affects the safety and noise immunity and may endanger personnel and/or equipment. Intentional disconnection of the earth connection is forbidden.

The wired rack may only be used in a fixed installation. The mains supply must be equipped with a suitable switch.

Before switching the equipment on, verify that the PSU's match the mains supply provided.

To ensure noise immunity, the sensor screens must be connected to the terminals provided.

To avoid external interference when switching loads, suitable suppression should be used.

19" rack connection diagram: Dwg nr. 3-110.536/...

NB: There are capacitors charged to the supply voltage on the PSU's.

8.2 IEC 61508-2-3 Specific Installation rules

The Ft3000 rack system must be installed in a key closed cabinet. Only trained people (service/installation people) have allowed access to the rack.

The signal cables and power supply cables must be installed separately on separated paths.

No ventilator required for the system.

Avoiding common mode failures : No rack displacement during the working of the rack.

The integrator must preconfigure the process parameters for each channel before running the main process. This configuration check can be done by driving the overspeed protection system without running the main process.

The integrated overspeed protection system must be pre-tested before running the main process (See maintenance specification for this test : periodic test).

There is no specific specifications for the starting procedure of the main process. These procedures depends on the OSPA / Main process integration and is full dependent of the integrator philosophy.

However the OSPA system must be started and ran when the equipment under controll is started.

9 Setting parameters and operation

9.1 Software concept

The input of various parameters is covered in section 5.11 and is via a user friendly operating system. Various windows permit the selection of functions and parameters using prepared menus.

9.1.1 Process parameter list

Using the PC software (Art. No.: 377A-72710) and the RS 232 interface on the FTK 3072 the following parameters can be configured.

Parameters and their values activated upon delivery are shown bold.

• Parameter input	Absolute / percent
• Min measuring time	0.01 ... 1.00s
• Number of measurements	1 .. 4
• Machine factor input	Machine factor / pulses per rev
• Machine factor 1...4	-9.9999 E+/-12 ... 1.0000 ... +9.9999 E+/-12
• Pulses per rev 1...4	1 ... 60 ... 65535
• Nominal speed 1...4	-9.9999 E+/-12 ... 1000.0 ... +9.9999 E+/-12
• Units 1...4	None / U/min / rpm / T/min
• Message acknowledgement	Without / with acknowledgement
• Process name	(8 characters)
• Lower set point 1...4 (Limit X low)	-9.9999 E+/-12 ... 1.0000 ... +9.9999 E+/-12
• Upper set point 1...4 (Limit X high)	-9.9999 E+/-12 ... 1.0000 ... +9.9999 E+/-12
• Analog output range 1...3	0/4...20mA 0/1...5mA 0/2...10V
• Measuring range start value	-9.9999 E+/-12 ... 1.0000 ... +9.9999 E+/-12
• Measuring range end value	-9.9999 E+/-12 ... 1000.0 ... +9.9999 E+/-12
• Sensor monitor (permissible deviation for dynamic monitoring)	-9.9999 E+/-12 ... 50.000 ... +9.9999 E+/-12
• Lower test value 1...3	-9.9999 E+/-12 ... 550.00 ... +9.9999 E+/-12
• Upper test value 1...3	-9.9999 E+/-12 ... 750.00 ... +9.9999 E+/-12
• Parameter enable - OEM	H0, H1, H2, H3, H4, H5, H6, H7
• Parameter enable - End user	H0, H1, H2, H3, H4, H5, H6, H7
• Parameter enable - micro terminal	H0, H1, H2, H3, H4, H5, H6, H7
• Password - manufacturer	*****
• Password - OEM	*****
• Password - End user	****

9.1.2 Configuration parameter list

The following configuration parameters are configurable via PC. (If a micro terminal is installed it can not be used to configurate these parameters.).

Parameters and their values activated upon delivery are shown bold.

• Machine factor	Global
• Input card	E01 / E02 / E03
• Optional converter	Without / with
• Converter type	FTW 3013
• Relay card	Without / with
• Relay card type	FTV 3090
• Microterminal	Without / with
• Configuration name	(8 characters)
• Permissible module addresses	0 ... 15
• System monitoring (LED's)	System, PS1, PS2, PS1 OR PS2, Sensor Monitor 1 Sensor Monitor 2, Sensor Monitor 1 OR 2
• Module OK signalling (influence on relays)	System, PS1, PS2, PS1 OR PS2, Sensor Monitor 1 Sensor Monitor 2, Sensor Monitor 1 OR 2
• Power supply monitoring	PS1 , PS2
• Sensor monitoring	Static, dynamic, majority, max value
• Analog output control 1...3	None, AbsolutA, AbsolutB, AbsolutC FunctionABC, MaxMem
• Analog output 1...3	20mA/5mA/10V
• Time constant on analog o/p	0.0 ... 9.9s
• If analog output 1 ... 3 deviation	Not off/off
• Limit control 1 ... 3	None/ speed monitor /comparator
• Speed monitor limit control 1 ... 3	None/ F1/F2/F3/F4
• Comparator limit control 1 ... 4	None/ AbsolutA/AbsolutB/AbsolutC FunctionABC/MaxMem
• Limit mode 1 ... 4	Normal/inverse
• Limit value table	Table0/table1
When Table 0 and fault case, the limit state corresponds to limit set point overgone When Table 1 and fault case, the limit state corresponds to limit set point undergone	
• Limit value 1 ... 4 LED's	Normal/inverse
• Time control - Limits 1 ... 4	Used/ not used
• Function - limits 1 ... 4	One shot/flip-flop
• Time - limits 1 ... 4	10s
• Edge - limits 1 ... 4	Positive/negative
• Control - relay 1 (Motherboard)	Limit1 / Limit 2 / Limit 3 / Limit 4 / Ok / PS / Mo / FW / BW / TestOn / PS1 / PS2
• Control - relay 2 (Motherboard)	Limit1 / Limit 2 / Limit 3 / Limit 4 / Ok / PS / Mo / FW / BW / TestOn / PS1 / PS2
• Control - relay 3 (Motherboard)	Limit1 / Limit 2 / Limit 3 / Limit 4 / Ok / PS / Mo / FW / BW / TestOn / PS1 / PS2
• Control - relay 1 (Relay card)	Limit1 / Limit 2 / Limit 3 / Limit 4 / Ok / PS / Mo / FW / BW / TestOn / PS1 / PS2
• Control - relay 2 (Relay card)	Limit1 / Limit 2 / Limit 3 / Limit 4 / Ok / PS / Mo / FW /

- Control - relay 3 (Relay card) BW / TestOn / PS1 / PS2
Limit1 / Limit 2 / Limit 3 / Limit 4 / Ok / PS / Mo / FW / BW / TestOn / PS1 / PS2
- Control - relay 4 (Relay card) Limit1 / Limit 2 / Limit 3 / Limit 4 / Ok / PS / Mo / FW / BW / TestOn / PS1 / PS2
- Control - binary inputs 1 ... 6 **None**/ResetLatch/ResetMax/LampTest/DirectionSet/SpeedMonitorInputA_Select/SpeedMonitorInputB_Select/UnderOver_Select, TestOn
- Input - frequency measurement A none/**F1**/F2/F3/F4
- Input - frequency measurement B none/F1/**F2**/F3/F4
- Input - frequency measurement C none/F1/F2/**F3**/F4
- Function output None/**MajorVoteABC**/MaxABC/MinABC/SigmaABC/SigmaAB/SigmaBC/SigmaAC/DeltaAB/DeltaBC/DeltaCA, Accel. 1,Accel. 2
- Max value memory None/**AbsolutA**/AbsolutB/AbsolutC/FunctionABC
- Frequency output 1 ... 3 None/**F1**/F2/F3/F4
- Standard direction **None**/FW/BW
- OnCmdSetDirection **None**/FW/BW
- OnPowerSetDirection **None**/FW/BW

9.1.3 Service parameter list

The detailed list of service parameters is available from JAQUET on request. Use of the service parameters is however reserved by the manufacturer and of no significance to end users.

9.2 PC communications

The FTK 3072 equipped with a RS 232 interface is required for communications between a PC and the various modules.

9.2.1 PC system requirements

386DX, 486DX or higher, equipped with Microsoft® Windows® 3.11 or higher, with serial interface COM1 or COM2 available and not running any application programs other than the FT 3000.

The PC to FT 3000 interface cable must be a screened D9 male to D9 female, connected 1:1. (See 9.4.2)

9.2.2 PC software installation

The FT 3000 software is supplied on 3.5" disk and is to be found under FT3000.EXE.

The file FT3000.EXE must be copied to a suitable directory using File Manager, eg C:\FT3000. Using Drag and Drop it can then be installed in the Program Manager.

If another application is using the serial interface, the FT3000 program will display an error message when started. The interface would then be set as 'none'.

Note: The first time the FT3000 program is used, the interface is set to 'none' and must be set up using the menu *Settings* and the command *Interface*.

Important: With operating system Windows 3.11, the Windows System File **SYSTEM.INI** under the (386Enh) section must be extended as follows:

COM1Buffer=8192	or	COM2Buffer=8192
COM1FIFO=ON (*)		COM2FIFO=ON
COMBoostTime=30		COMBoostTime=30

(*) **With operating system Windows 95 or later, the FIFO of the serial interface has to be disabled.**

The application will then be ready **after Windows** has been **rebooted**.

9.2.3 Optimisation

Various settings can be made in the initialisation file FT3000.INI that is saved in the Windows directory for the FT3000 application the first time the program is exited.

The following settings are made from the FT3000 application menu - 'Settings' and should not be altered with a text editor:

(Settings)

CommPort=1	1 = COM1
CommDirControl=0	0 = DTR control line
CommTimeOutEcho=20	Time out in ms if the PC does not receive an echo (irrespective of data amount)
CommTimeOutEchoCharacter=5	Additional time out per character in ms if the PC does not receive an
CommTimeOutResponse=200	Time out in ms if the PC does not receive an answer from the FT3000
CommTimeOut=50	Additional time out per character in ms if the PC does not receive an answer from the FT3000 (dependent on data amount)
CommDelayTimeCommand=10	Minimum time in ms that the PC allows from receipt of one response to sending a new command to the FT3000
DisplayInterval=2500	PC display interval for measured data

Note: By reducing the times shown in bold the data transfer may be speeded up. However, this increases the risk of a data crash, especially when using an older or slower PC, since the FT3000 requires a minimum time to respond to PC commands.

9.2.4 Setting the display interval

The display interval of measured data and additional messages on the PC can be set in the range 0.25 ... 10seconds. This cannot however be guaranteed due to the way Windows handles multi tasking.

9.2.5 Protection of configuration parameters

As standard, the configuration parameters are protected from being changed via PC password.

An OEM password level is provided for changing parameters as defined in 9.3.6 and 9.3.7.

The OEM should be aware that changing parameters can alter the whole FT3000 system that would in principle correspond to changing the wiring.

9.2.6 Protection of process parameters

As standard, the process parameters are protected from being changed via PC password.

A user password level is provided for changing parameters as defined in 9.3.6 and 9.3.7.

9.2.7 Reading and writing parameters

Reading or writing of parameters occurs after confirmation in the dialogue box <Confirm parameter read/write>. When reading parameters, the configuration and process parameters per module should always be read together.

If the configuration and process parameters are read into a new file, then the construction of the FT3000 must be defined. All FT3000 modules can then be automatically interrogated.

9.2.8 Parameter printout

FTFU 3024 configuration and process parameters are separately printed out for one module at a time.

The module selected is shown in the PC window top left. Selection is via <- and -> scroll keys.

9.2.9 Display of current measured data

The display of current measured data is for one module at a time. Module selection is via <- and -> scroll keys.

9.3 Setting parameters

Parameter configuration is via the FTK 3072 comms module, a RS 232 PC interface and the FT3000 application program.

Within the aforementioned range the parameters can be changed either ON-LINE (via comms module FTK 3072 and RS-232 PC interface) or OFF-LINE by selection of the corresponding menu and change of the desired parameters.

OFF-LINE (without connected FT 3000-system):

1. With the FT 3000 command: < configuration: module on the unit > the modules installed must be identified by means of activating the corresponding bush button on the configuration dialogue <module on the unit> and confirming this with <OK>.
2. Only **after** step No.: 1 the dialogues for the configuration- and process-parameters can be called.
3. To change a parameter a password must be used (see 9.3.6 and 9.3.7)

Attention: Each parameter change only becomes effective after the PC command *FT3000 - write parameters* is given and the FT3000 has stored the new parameters.

There are 7 process parameter functions: <System settings>, <Sensor monitor>, <Analog outputs>, <Limit values>, <Test values>, <Parameter enable> and <Password>.

9.3.1 System settings

9.3.1.1 Parameter input

The parameters for <Sensor monitor>, <Analog outputs>, <Limit values> and <Test values> can be entered as **absolute** or percentage values of nominal speed.

9.3.1.2 Nominal speed

The nominal speed must be specified if parameters are inputted as percentage values.

Please note the following if the nominal speed is changed:

- If parameter input is in absolute values, a change to the nominal speed will not result in recalculation of the absolute values - Speed deviation, Analog measuring range, Limit set points, Test values.
- If parameter input is in percentage values, a change to the nominal speed will result in recalculation of the absolute values - Speed deviation, Analog measuring range, Limit set points, Test values.

Whether recalculation takes place is based on the setting Absolute or % in the application program.

9.3.1.3 Units

When entering parameters in absolute values, a unit may be specified eg rpm.

9.3.1.4 Machine factor

The machine factor $M = f/n$ where

- f Hz = sensor signal for a given speed
- n rpm = machine speed

In place of the machine factor, the **number of pulses** per rev (= nr. of poles on the gear wheel) can be entered.

The machine factor is then automatically calculated as $M = \text{ppr}/60$.

9.3.1.5 Measurement (Min measuring time and number of measurements)

The **min. measuring** time determines the minimum period during which the input frequency is measured. The effective measurement time is terminated upon completion of the min measuring time by the next positive edge of the input frequency.

A long **min measuring** time can be used to average out variances of the input frequency but it increases the output reaction time to step changes in speed.

The **min measuring** time can be set in increments of 10ms from 0.01 to 1.00 seconds.

To suppress variances showing up in the measured **data**, 1 to 4 **measurements** can be averaged without the need to increase the measuring time.

9.3.1.6 Message acknowledgement

‘**With acknowledgement**’, messages are stored until reset eg via configured binary inputs or PC command.

Or -

‘**Without acknowledgement**’, messages are not stored.

9.3.1.7 Process name

The process name (max 8 characters) serves to identify the application of individual plug in modules.

9.3.2 Sensor monitor

With 3 channel 2 out of 3 monitoring, the max permissible speed difference between 2 channels must be specified.

9.3.3 Analog outputs

The following parameters can be independently set for each of the 3 analog outputs.

9.3.3.1 Measuring range start value

The value entered tells the FTW 3013 what frequency corresponds to, for example 0mA.

9.3.3.2 Measuring range end value

The value entered tells the FTW 3013 what frequency corresponds to, for example 20mA.

For a falling characteristic the end frequency value must be smaller than the start value.

9.3.3.3 Output range

In standard FTW 3013 units this is set to *normal* (0...20mA or 0...5mA or 0...10V).

Output range with zero suppression corresponds to 4...20mA or 1...5mA or 2...10V.

9.3.4 Limit values

The following parameters can be independently set for each of the 4 limit values.

9.3.4.1 Set point

The limit value can be defined with an *upper* and *lower set point*.

If in the configuration <Limit value control> was defined as *normal*, exceeding the upper set point activates the limit. It then becomes inactive when the speed drops below the lower set point.

If in the configuration <Limit value control> was defined as *inverse*, then when the speed drops below the **lower** set point it is **active**. It then becomes inactive when the speed exceeds the **upper** set point.

9.3.4.2 Pulses

If during configuration <Limit value control> was specified as *SpeedMonitor*, the number of pulses to be used for the measurement must be defined.

If during configuration <Limit value control> was specified as *Comparator*, this entry is not required. Limit 4 is always defined as *Comparator*.

The FT 3000 Windows software will allow a minimum pulse value to be set, which is appropriate to the limit setting. In the event that trips occur at speeds apparently below the limits selected, then this may be the result of gear machining inaccuracies. The solution to this is to increase the number of pulses used to say 20% of the number of teeth on the gear.

9.3.5 Test values

If during configuration <Limit value control> was specified as *SpeedMonitor*, **upper and lower test values** are available for each limit. Internally generated square wave signals corresponding to the speed set points are fed to the respective speed monitor input during testing in place of the input signal. This is controlled by suitably configured binary inputs or via PC commands.

9.3.6 Parameter enable

The individual configuration and process parameters have the following fixed hierarchy:

H0 - Process 0	Absolute / %, ProcessName
H1 - Process 1	Limit_High, Limit_Low, SpeedMonitor_Pulses, Analog_Full, Analog_Zero,
H2 - Process 2	MachineFactor, NominalSpeed, PulsesPerRev, FixTime, NumberOfMeasurement
H3 - Config 0	LimitMode, LED-Mode, ConfigName
H4 - Config 1	All configuration parameters excl. H3 - Config 0 and H5 - Config 2
H5 - Config 2	ModuleInstallationByte
H6 - Service	ServiceParameter, Calibration
H7 - Commands	FT3000 commands (ReseMaxMem, LampTest etc)

The individual hierarchy levels can be enabled or disabled for the OEM and End User.

To change the parameter enable for the End User, the OEM's password is required.

To change the parameter enable for the OEM, the manufacturer's password is required. With the manufacturer's password, the End User parameter enable can also be changed.

The password must be entered each time a parameter is changed, whereby OEM's and End Users can only change parameters that their passwords allow.

If the password is accepted, then changes are allowed up until the configuration file is saved or the parameters are written to the FT3000 module. For any further changes the password has to be re-entered.

If the password is rejected, then no changes are possible.

9.3.7 Password

Following entry of a valid password, a new password may be defined. The OEM can change the End User's password but not vice versa.

The successful password change must be written to all installed FT3000 compact modules using *Write FT3000 Parameters* and to the FTC file in the PC. Permissible password characters are - A...Z, 0...9 and the characters - and _. Lower case letters are automatically interpreted as upper case.

Max password length is 6 characters.

Note: Within one installation, all process parameters, with the exception of the password, are module specific;ie. they may vary from one compact module to another. The passwords must however be the same.

9.4 Operating behaviour

9.4.1 Power up

Analog outputs: After connecting the supply and until the first measurement, the output corresponds to the analog start value configured.

Relay output: After connecting the supply the relays are initially inactive and then assume the state defined under <Limit value control>

The first positive edge of the signal input starts the first frequency measurement

- Upon completion of the first measurement relays assigned to limit control assume the state corresponding to the measurement.
- If Comparator is configured and no input frequency exists, relays assigned to limit control assume the state defined as - speed below lower set point after 20 s.
- If Speed Monitor is configured and no input frequency exists, relays assigned to limit control assume the state defined as - speed below lower set point after a measurement time corresponding to Limit x High.

9.4.2 Measurements

- A measurement starts with the positive edge of the input frequency. Following the Fixed Time, the next positive edge terminates the measurement and starts another.
- The total resulting measurement time has a resolution of +/- 0.4µs.
- The calculation and control of the outputs occurs during the next immediate measurement.
- The transfer to the PC and display of measurement values and status occurs within the display interval configured.
- If the analog ranges are exceeded, the output goes to the end values configured.

9.4.3 Response to sensor failure

- Should the input frequency suddenly and totally fail, the measured value and analog output follows an exponential step function towards the start value as soon as the period of the new measurement is 2, 4, 8 times larger than the period of the last measurement.
- Should the input frequency suddenly and totally fail, measured values below the lower set points register speed below lower limit.
- If the sensor's current consumption exceeds the predefined limits the message 'StaticMonitorFlag1' is set to 0.

9.4.4 Behaviour during system alarm

- If the module is in *Config Mode* (red NOK-LED on and green OK-LED flashing at 1Hz) or in *Service Mode* (red NOK-LED on and green OK-LED flashing at 0.5Hz) the analog outputs go to 0mA (0V) and the relays are de-energised. All LED's - BW, FW, LIMIT 1...4 are off.
- If the module is in *Process Mode* and Alarm Condition (red NOK-LED on and green OK-LED off), the analog outputs go to 0mA (0V) and the relays assume the status corresponding to the limit value control configuration. The LED's LIMIT 1...4 also assume the status defined under Limit value control.
- If the module enters *Process Mode* from *Config Mode* or *Service Mode* and an alarm condition occurs, the analog outputs go to 0mA and the relays de-energise. All LED's - BW, FW and LIMIT 1...4 are off.

9.4.5 Response to mains failure

- If the mains fails for longer than the permitted time, the analog outputs go to 0mA and the relays de-energise. When the supply returns the unit goes through the power up routine (see 7.4.1)
- Should the internally stabilised supply drop below the minimum specified voltage, then this is detected as mains failure.

9.5 Frequency measurement calibration

The modules are calibrated at the factory and the data stored in EEPROM.

There are no manual adjustments on the FTW 3013 converters for output current range. Eventual faults must be corrected at the factory.

There are no manual adjustments on the FTFU 3024 monitoring modules. Eventual faults must be corrected at the factory.

9.5.1 Calibration tools

- Frequency sources:

Accurate frequency generator or generator with digital tachometer having accuracy better than 0.05% of the frequency setting. Where a lower demand on the accuracy exists, calibration can take place on the machine. The sensors then act as the frequency source and would be measured by a digital tachometer. **The machine factor M must be taken into account**, ie. the relationship between frequency and machine speed.

- Measurement of output current/voltage:

Precision instrument with an accuracy better than 0.05% or the integral meter. Errors in the integral meter are then automatically calibrated out and the accuracy of the total system depends upon the accuracy of the frequency source.

9.5.2 Factors influencing accuracy

- Quartz crystal:

Temp. Drift	+/-10ppm over the total temp. Range
Long term drift	+/- 5ppm/year
Failure rate	< 15 fit

- Reference source:

Temp. Drift	+/-50ppm/ Deg. K
Long term drift	typically +/- 1ppm/1000hrs
Failure rate	< 4.5 fit

- Precision resistors

Temp. Drift	+/-50ppm/Deg. K
Long term drift	<+ 500ppm/year
Failure rate	< 0.7 fit

- Trimmers

Temp. Drift	+/-100ppm/Deg. K
Long term drift	<+ 500ppm/year
Failure rate	< 100 fit

9.5.3 Calibration rules

During calibration the previously frequency sources and measuring instruments must be used. Measurements should be compared with calibration values and any variances noted.

- Calibration of the analog outputs:

Input frequency corresponding to configured start value:

Actual value = start value

Analog output value = 0.00% (display only with FTW 3013)

Input frequency < 'Min displayed measured value' configured = display of 0000.

FTW 3013 analog output corresponds to configured start value.

Input frequency corresponding to configured end value:

Actual value = end value

Analog output value = 100.00% (display only with FTW 3013)

FTW 3013 analog output corresponds to configured end value.

Input frequency in the middle of configured start and end values:

Actual value = mid value

Analog output value = 50.00% (display only with FTW 3013)

FTW 3013 analog output corresponds to mid value.

Display or output variances can, within limits, be adjusted at a suitably equipped work station.

- Set point calibration:

Operating status - on.

10 Mechanical construction

See also sections 3 and 4.

Up to 21 19" rack modules of 4 unit width can be installed in one rack. Every module is fixed into the rack using slides and retained screws. The screws provide an earth connection to the module's front panel.

Every module consists of an electronic card fixed to the front panel along with eventual additional components. Electrical connections are via card connectors in accordance with DIN 41612.

Auxiliary cards such as the FTW 3013 converter and FTV 3090 relay card are plugged onto the FTFU 3024 motherboard, with connections via the internal local bus. These cards can therefore only be plugged in or removed together despite having separate front panels.

The arrangement of auxiliary modules is such that the motherboard is always far left and any relay card is far right.

A converter card would sit in between.

The input card is also plugged onto the motherboard but without a front panel.

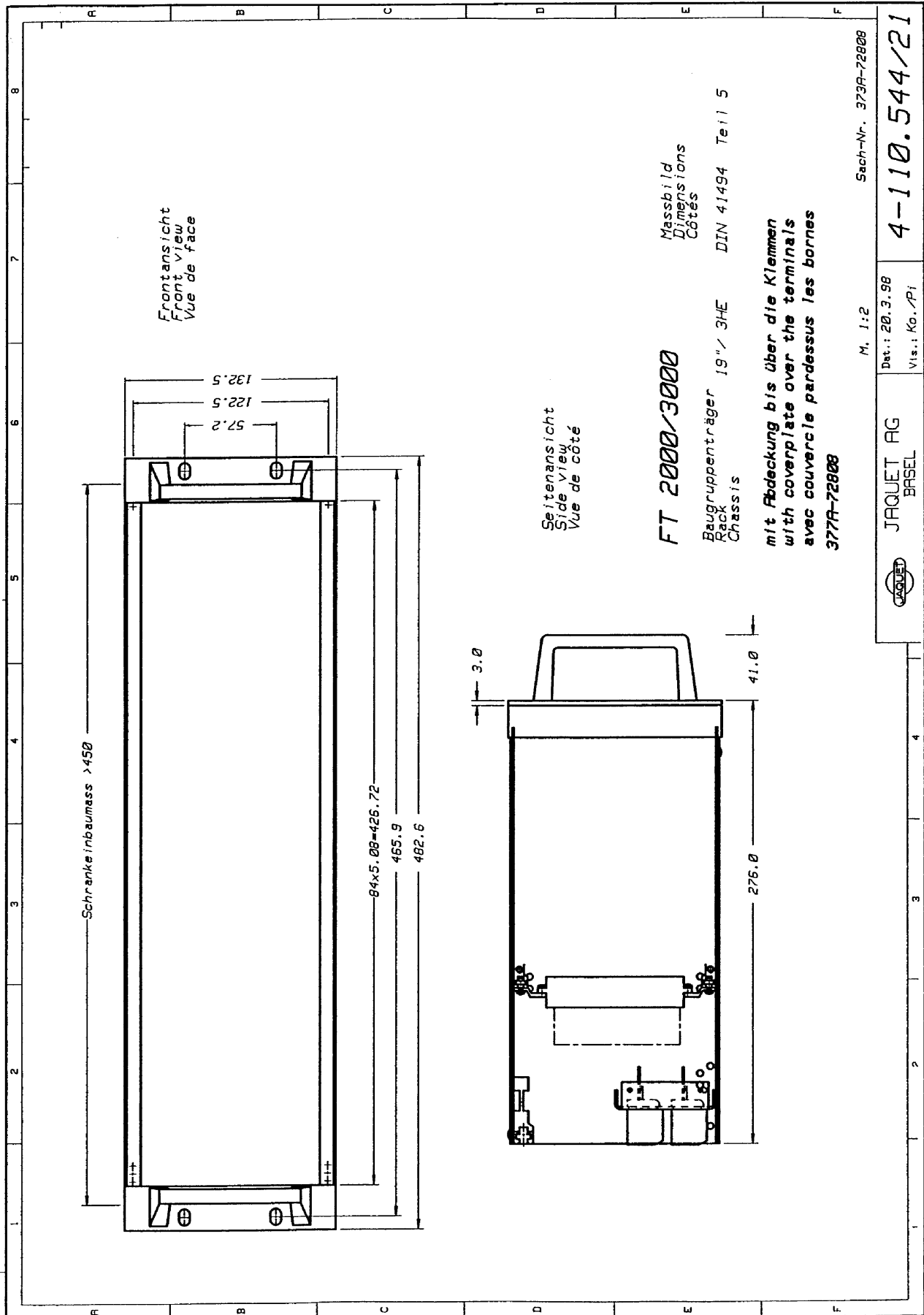

Sach-Nr. 373A-72808

M, 1:2

Det.: 20.3.98

Vis.: Ko./Pi

JAQUET AG
BASEL



4-110.544/21

11 Circuit description

See also section 5

11.1 FTFU 3024 Motherboard and input card

11.1.1 Frequency measurement

The measurement chains for the 3 frequency measurements are implemented in hardware in the 3 ASIC's. The resultant floating point measurements <AbsolutA>, <AbsolutB> and <AbsolutC> are fed to the mpu for further processing.

Every measurement input is fed with one of 5 possible input signals configured via software - none, F1, F2, F3, F4.

A 10MHz quartz oscillator provides the timebase for the frequency measurement and speed monitors.

11.1.2 Speed monitors

The speed monitors are implemented in ASIC's. Since there are 3 ASIC's, 3 speed monitors are available.

The ASIC has two 32 Bit registers for measuring time and one 8 Bit register for pulses.

The resultant max measuring time is 859s with max processable frequency of 510khz.

The measurement resolution is 400ns.

11.1.3 Micro controller

internally 1 K Byte of RAM
 8 channel, 10 Bit A/D converter
 serial interface

Operation in expanded Multiplex mode

Quartz frequency 16 Mhz

Clock cycle 250ns

Address demultiplexer

32 K Byte EPROM (one time programmable)

11.1.4 Supply

The supply voltage is derived from 2 redundant PSU's, PS1 and PS2, that are separately fused. The 2 voltages are monitored after the fuses by the mpu using A/D converters. The green front panel LED's *PS1OK* and *PS2OK* are on when the PSU's are within tolerance:

Continuous overvoltage $\geq 38Vdc$ on the supply input causes the fuse to break

Continuous overvoltage $> 33Vdc$ on the supply input can cause the fuse to break

Continuous undervoltage $13...18Vdc$ on the supply input does not affect the fuse

Continuous undervoltage $< 13Vdc$ on the supply input can cause the fuse to break

Any relay on either the FTFU 3024 motherboard or the FTV 3090 relay card can be used to signal PSU status. Relay 3 on the FTFU 3024 is allocated at the factory for this function.

After the fuses the 2 voltages PS1 and PS2 are diode decoupled to form a secure supply PS3. The diodes also provide reverse polarity protection. Over voltage protection and storage capacitors ensure a secure 24V internal supply.

The **power on surge** of the FTFU 3024 is limited to 7A for 2.2ms by a 4.7 Ohm resistor.

The **power on surge** of the E01 input card is limited to 3.3A for 1ms by a 10 Ohm resistor.

The following **supply voltages** are generated on the FTFU 3024:

Ulogic =	+5.00Vdc: Switched regulator to supply the logic, mpu, ASIC etc.
UFOut1 =	+12Vdc: Linear regulator to supply the frequency output drivers.
UFOut2 =	+12Vdc: DC/DC converter to supply the isolated frequency outputs.
Uin =	+12 Vdc:DC/DC converter to supply the input module

11.1.5 Reset and non-maskable interrupt (NMI)

A hardware NMI reset circuit monitors the voltage Ulogic. The reset time constant is 200ms. Following this time, the mpu carries out a reset routine.

A hardware **NMI reset** circuit monitors the input voltage +Vin to the Ulogic regulator.

If +Vin < 16V, NMI output = Low
 +Vin > 16V, NMI o/p = High

The NMI input on the mpu reacts to a negative edge, ie if the input voltage sinks below +16V (eg if the supply is turned off)

The NMI routine causes the following:

- Termination of current measurement
- mpu ports become high resistance to reduce current demand
- NMI input to the mpu is monitored so as to initiate a reset routine

Should the supply suddenly fail, there is enough charge in the storage capacitor to ensure the above actions are executed before the reset circuit becomes active.

11.1.6 Input amplifier

Current limited signal input, ac coupled with subsequent Schmitt trigger.

Sensor supply with protection diode, current limiting, shunt and differential amplifier for sensor current monitoring.

11.1.7 Sensor monitoring

Sensor monitoring is possible via static or dynamic monitoring or a combination of both. The front panel LED 'MO' is on when no sensor fault has been detected. Otherwise the red LED lights.

Any relay on the FTFU 3024 or the FTV3090 relay card can be allocated to the sensor monitor function.

Relay 2 on the FTFU 3024 is allocated at the factory.

Static monitoring (realised in hardware on the input card)

A code resistor on the input card tells the mpu's A/D converter what input card type is installed and the number of sensors to monitor.

The current consumption of every sensor is monitored to be within the limits set via the front panel potentiometers.

Dynamic monitoring (by the mpu)

For multi-channel applications (2 of 3 or 1 of 2), the dynamic sensor monitor compares the sensors frequencies.

For 2 of 3 monitoring, the max permissible difference between 2 measurements (as absolute speed or % of nominal) is monitored ie Measured value A - Measured value B, Measured value B - Measured value C and Measured value C - Measured value A. The sensor status is derived from these differences as follows:

C-A	B-C	A-B	Sensor C	Sensor B	Sensor A
NOT OK	NOT OK	NOT OK	NOT OK	NOT OK	NOT OK
NOT OK	NOT OK	OK	NOT OK	OK	OK
NOT OK	OK	NOT OK	OK	OK	NOT OK
NOT OK	OK	OK	*OK	*OK	*OK
OK	NOT OK	NOT OK	OK	NOT OK	OK
OK	NOT OK	OK	*OK	*OK	*OK
OK	OK	NOT OK	*OK	*OK	*OK
OK	OK	OK	OK	OK	OK

* In this case the double difference is allowed.

For 1 of 2 monitoring the max permissible difference between 2 measurements (as absolute speed or % of nominal) is monitored ie Measured value A - Measured value B. The sensor status is derived from this difference as follows:

Difference > permissible value - the sensor delivering the higher value is assumed OK.

11.1.8 Module monitoring

The following functions can be logically configured via software to provide module monitoring:

- System OK
- PS1 OK
- PS2 OK
- Sensor OK

If the module is OK or when the logically combined functions are OK the green OK LED lights and the red LED is off.

Any relay on the FTFU 3024 or on the FTV 3090 can be used for signalling module status. Relay 1 on the motherboard is assigned at the factory.

11.1.9 Relay outputs

The motherboard has 3 relays with change over contacts. The relays can be assigned to various functions via software.

11.1.10 LIMIT LED's

The 4 green and 4 red LIMIT LED's can be configured via software such that either red or green light at the corresponding upper/lower set points.

11.1.11 Frequency generator

The frequency generator consists of a 32 Bit down counter in ASIC 3. From the zero state it is loaded from one of 2 software defined settable reload registers. 2 test frequencies can thereby be programmed and reliably selected.

A frequency change can only occur after one half period of the previous frequency, thereby avoiding any sudden change to the dc average voltage of the test signal.

The frequency generator output from ASIC 3 is fed to all ASIC inputs F4 via the input card.

11.1.12 Frequency outputs

Each of the 2 frequency outputs can be fed with one of 5 input signals - None, F1, F2, F3, F4, via software configurable ASIC.

Following power up and as long as the reset routine is in progress, no output signals are provided.

11.1.13 Binary inputs

The binary inputs B1 and B2 have common reference with the minus terminal on the supply and have an internal pull up resistor of 10KOhm to +5V. To active the input it need only be pulled down to 0V (=minus terminal on the internal 24V module supply).

Binary inputs B3...B6 have a common floating reference. The isolation is via 4 optocouplers. To activate these inputs an external supply is required.

If more than one input is given the same allocation, the input with the highest index is dominant (eg B3 in place of B2).

11.1.14 Test

The test frequency from the generator can only be switched to one of the 3 speed monitors at any one time.

(See 9.1.2)

As long as the test frequency is connected, the green OK LED flashes (0.5s on, 0.5s off).

During activation/deactivation of the test, the original speed monitor status is retained such that no illegal operating conditions can arise.

11.1.15 Direction of rotation discriminator

The determination of phase relationship between the input signals enables the direction to be established. The required logic is in the ASIC's. The mpu controls the display and eventual relay status. The front panel LED's *BW* (backwards) and *FW* (forwards) signal the direction of rotation.

11.1.16 Lamp test

The lamp test applies to all FTFU 3024 and eventual auxiliary module LED's. It is activated via the configured binary input. During testing only the LED's are affected. The relays remain under control of the measurement system.

11.2 FTW 3013 - A/D converter auxiliary module.

11.2.1 Supply

The **supply is fed** in via the local bus.

The **power on surge** is limited to 0.1A for 155ms by a 330 Ohm resistor.

With this module, the current limiting resistor is short circuited after approx. 0.8s following power up.

11.2.2 Analog outputs

Three separate isolated converters are available to provide dc signal outputs. Each output is controlled by a 12 Bit digital value from the local bus, derived from the PWM (pulse width modulation) output from the ASIC.

The PWM frequency is dependent upon the output value and is 312Hz min. A subsequent single ended low pass filter dampens the ripple to less than 0.1%.

An additional single ended digital low pass filter with software configurable time constant enables further suppression of fast changes to the output signal.

A noise filter suppresses external interference on the line.

11.3 FTV 3090 Relay card

11.3.1 Supply

The **supply is fed** in via the local bus.

The **power on surge** is limited to 0.1A for 155ms by a 330 Ohm resistor.

With this module, the current limiting resistor is short circuited after approx. 0.8s following power up.

11.3.2 Relay outputs

The FTV 3090 possesses 4 extra relays each having change over contacts. The relays can be assigned via software to various functions.

11.4 FTK 3072 Comms module

11.4.1 Rack bus

The rack bus is laid out as a RS 485 serial data bus and provides communications between the FTK 3072 and those modules equipped with a corresponding interface:

- FTFU 3024 motherboard
- FTM 3000 micro terminal

The rack bus connections to the modules are via the card connectors.

11.4.2 RS 232 interface

The interface is accessed via the front panel D9 connector on the FTK 3072.

Transfer rate: 2400 Baud
 Parity: None
 Data bits: 8
 Stop bits: 2
 Connector: D9

The connection diagram shows the names with respect to the equipment interface. RXD on the FT3000 must be connected to RXD on the PC, and also for TXD.

The interface operates at the standard voltages. Protection against external overvoltage is provided.

RS-232 Interface
9 Pin D SUB

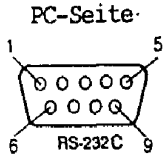

RS-232 Interface
9 Pin D SUB

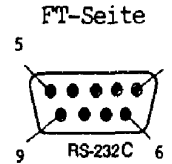

Pin Number	Signal Name	I/O
1	Carrier Detector	I
2	Received Data	I
3	Transmitted Data	O
4	Data Terminal Ready	O
5	Signal Ground	
6	Data Set Ready	I
7	Request to Send	O
8	Clear to Send	I
9	Ring Indicator	I

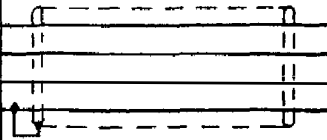

Pin Number	Signal Name	I/O
1	Carrier Detector	I
2	Transmitted Data	O
3	Received Data	I
4	Data Terminal Ready	O
5	Signal Ground	
6	Data Set Ready	I
7	Request to Send	O
8	Clear to Send	I
9	Ring Indicator	I

12 Maintenance

The electronic boards do not need any special maintenance activity.

12.1 Periodic test

12.1.1 Description

The periodic test is used for proving the capacity of the system to detect an overspeed and to transmit the detection. This has to be applied to the Overspeed Protection System, and to the Trip Chain Control System if available.

The periodic test is realised for each channel separately. It is a serious error trying to test more than one channel at one time. It would generate systematically an overspeed trip.

By asserting a binary input of the system the corresponding channel is tested. Each channel has an own logic input.

12.1.2 IEC 61508-2-3 specifications



The periodic test is necessary for reaching the IEC 61508-2-3 requirements, then obligatory.

The periodicity of this test must be ≤ 3 months.

Between each channel test, a no test delay of 10 minutes must be implemented.

The execution of the test removes the sensor signal on the tested channel and replaces it by the signal coming from the on the module FTFU3024 implemented frequency generator configured to a frequency about 1% higher than the overspeed frequency. The relay corresponding to the overspeed set point must de-energise. The effect of the de-energised overspeed relay must be checked by the end user.

Periodic test for the Saignal Monitoring System :

Mostly of the integrated functionalities of the FTBU 3x34 card are on board redundant. Especially the inputs stages of the signal monitoring paths. The execution of the test replaces the input logic combination witch is needed to generate a trip on the OUT output, and the output is asserted (relay OUT deenergized). The effect of the deenergized relay must be checked by the end user.

12.2 Trouble shooting :

Trouble shooting is needed when the S + M + P Alarm signal is asserted, or when the system behaviour under periodic test condition is false.

12.2.1 Procedure for the OSPS

The Following procedure has to be applied :

- If the red MO LED of a channel is on : (Sensor Monitoring)
 - Exchange the channel module (see chapter Module exchanging)
 - If the trouble stays, replace the original channel module and exchange the sensor.
 - If the trouble stays, exchange the channel module and the sensor.
 - If the trouble stays, check the rack and sensor wiring, check the 3 sensor signals, exchange the sensor if signal false.

- If the OK LED of a channel is red : (System Monitoring)
 - Exchange the channel module (see chapter Module exchanging)
 - If the trouble stays, check the rack wiring.

- If the PSI or PSII led is off on each channel : (Power supply Monitoring)
 - Exchange the corresponding power supply
 - If the trouble stays, check the rack wiring.

- If the PSI and/or PSII led is off on one channel : (Power supply Monitoring)
 - Exchange the corresponding channel module
 - If the trouble stays, check the rack wiring.

- If no red LED is on, and no PSI/II LED off and the periodic test for one channel is false :
 - Exchange the corresponding channel Module
 - If the trouble stays, remove the new module, check the rack wiring, and terminal connections.

After a repair, a periodic test must be performed for each channel.(see chapter Periodic test).



Description of the diagnostic who's continuously performed in the system :

- System monitor: If a system failure occurs (CPU Test, Configuration parameter integrity test, Process parameter integrity test and Service parameter integrity test , both power supply out of range, auxiliary module not present, FPGA not programmed) the red Led MO\ on the front plate goes on and the green Led MO goes off or blinks depending if the failure occurs in process mode, configuration mode or service mode. The Module OK relay de-energise. All the relays on FTFU3024 and FTV3090 de-energise, the analog outputs goes to 0 mA/V. So in a 3 channel system, when trip contact is open to trip, the channel goes in a safe state.
- Supply monitor : If a supply failure occurs (power supply voltage out of the 18...33VDC range) the corresponding green Led PS1 or PS2 on the front plate goes off and the Module OK relay de-energise. The case of an out off range of both power supplies is taken in account by the system monitor.
- Sensor monitor: The sensor and the line between sensor an rack is monitored by the static monitoring. The signal delivered by the sensor is also monitored by the dynamic monitoring. If a sensor failure occurs in one channel the relay corresponding to the overspeed set point de-energise i.e. takes the state as in overspeed : the channel goes in a safe state.

12.2.2 Procedure for the TCCC :

The Following procedure has to be applied :

- If the OK LED of a channel is red : (System Monitoring)
Exchange the channel module (see chapter Module exchanging)
If the trouble stays, check the rack wiring.
- If the PSI or PSII led is off on each channel : (Power supply Monitoring)
Exchange the corresponding power supply
If the trouble stays, check the rack wiring.
- If the PSI and/or PSII led is off on one channel : (Power supply Monitoring)
Exchange the corresponding channel module
If the trouble stays, check the rack wiring.
- If no red LED is on, and no PSI/II LED off and the periodic test for one channel is false :
Exchange the corresponding channel Module
If the trouble stays, remove the new module, check the rack wiring, and terminal connections.

After a repair, a periodic test must be performed for each channel.(see chapter Periodic test).



12.2.3 IEC 61508-2-3 specifications

The mean time to repair is fixed to 8 hours. The end user is responsible for reaching this repair time and has to realise the needed conditions for reaching it. The 8 hours include :

- 2 hours for the comeback of the service people.
- 2 hours for the trouble analysis.
- 2 hours for the correction definition.
- 2 hours for the trouble correction.



12.3 Module exchanging :

12.3.1 General

The repair is performed by exchanging modules. The exchanging module set includes :

- 1 sensor
- 1 configured channel modul including :
 - 1 FTFU 3024 card, if used one FTV3x90 card and one FTW3x13 card.
- 1 power supply if used
- if used, one TCCC channel modul FTBU 3x34



The electronic modules are field hot-replacable, the sensor too. Generally, one additional sensor is premoneted in the process so one sensor exchange can be realised without stoping the main process.

Only modules in one channel can be removed at one time. It is a serious error trying to exchange modules in more than one channel at one time. It would generate systematically an overspeed trip.

12.3.2 IEC 61508-2-3 specifications :



The modules can not be reallocated one channel to an other.

An exchanging module set has to be available at the installation so that the mean time to repair can be reached (8 hours). This module is configured in stock. After a repair where the in stock module were used, a new configured module must be set in stock. The burned-in Modules (100 Hours 50°C) are supplied from the OSPS supplier, the integrator configures the module and set it in stock at the installation.

Only trained service people is allowed to performe any maintenance activity : Periodic test, trouble shooting. Trained people means people who have a good knowledge of the installation and maintenance procedure of the system, people who know the significance of a 2oo3 system, people who have at one's disposal all the 4 core system descriptions :

- The bloc fonction description of the system
- The face description of the system
- The terminal description of the system
- The operating instructions manual of the system

13 Storage

The long term storage temperature range is -25 ... +85°C.

The short term storage temperature range is -40 ... +90°C (max one day at any time, without any mechanical loading)

If the unit is suddenly cooled, condensation may occur, which considerably reduces the insulation resistance.

14 Warranty

The FT3000 is guaranteed for 12 months from the ship date. Please see JAQUET's full terms and conditions.

15 Drawings

Description	Type	Dwg. Nr.
Block circuit diagram		4-110.505
Lay-out of the rack		3-110.545
Occupancy and wiring of rack		3-110.536
Dimensions:		
• Rack		4-110.544/21
• Modules		4-110.544/2
Connection diagrams of the modules:		
• Motherboard	FTFU 3024	4-110.531/23
• Frequency to current converter	FTW 3013	4-110.531/24
• Relay module	FTV 3090	4-110.531/25
• Comms module	FTK 3072	4-110.531/26
• TCCC card	FTBU 3x34	4-110.531/30