

Electronics



Permanent operation microprocessor burner control device

ESA GENIO-S (E7021 rev. 01 - 06/05/2015)

GENERAL WARNINGS:



■ All installation, maintenance, ignition and setting must be performed by qualified staff, respecting the norms present at the time and place of the installation.

■ To avoid damage to people and things, it is essential to observe all the points indicated in this handbook. The reported indications do not exonerate the Client/User from observing general or specific laws concerning accidents and environmental safeguarding.

■ The operator must wear proper DPI clothing (shoes, helmets...) and respect the general safety, prevention and precaution norms.

■ To avoid the risks of burns or high voltage electrocution, the operator must avoid all contact with the burner and its control devices during the ignition phase and while it is running at high temperatures.

■ All ordinary and extraordinary maintenance must be performed when the system is stopped.

■ To assure correct and safe use of the combustion plant, it is of extreme importance that the contents of this document be brought to the attention of and be meticulously observed by all personnel in charge of controlling and working the devices.

■ The functioning of a combustion plant can be dangerous and cause injuries to persons or damage to equipment. Every burner must be provided with certified combustion safety and supervision devices.

■ The burner must be installed correctly to prevent any type of accidental/undesired heat transmission from the flame to the operator or the equipment.

■ The performances indicated in this technical document regarding the range of products are a result of experimental tests carried out at ESA-PYRONICS. The tests have been performed using ignition systems, flame detectors and supervisors developed by ESA-PYRONICS. The respect of the above mentioned functioning conditions cannot be guaranteed if equipment, which is not present in the ESA-PYRONICS catalogue, is used.

DISPOSAL:



To dispose of the product, abide by the local legislations regarding it.

GENERAL NOTES:



■ In accordance to the internal policy of constant quality improvement, ESA-PYRONICS reserves the right to modify the technical characteristics of the present document at any time and without warning.

■ It is possible to download technical sheets which have been updated to the latest revision from the **www.esapyronics.com** website.

■ The products manufactured by ESA-PYRONICS have been created in conformity to the **UNI EN 746-2:2010** Norms: Equipment for industrial thermal process - Part 2: Safety requirements for combustion and the movement and treatment of combustible elements. This norm is in harmony with the Machine Directive **2006/42/CE**. It is certified that the products in question respect all the requirements prescribed by the above mentioned Norms and Directives.

■ Certified in conformity with the **UNI EN ISO 9001** Norm by DNV GL.

CERTIFICATIONS:



ESA GENIO-S conforms to **EN 298 CE599253** according to the certificate issued by notified body **0086**. ESA GENIO-S complies with EU directives: Gas directive **2009/142/EC**, Low Voltage Directive **2014/35/UE**, Electromagnetic Immunity **2014/30/UE**, in union with **EN298** and **EN746-2**.

The products meet the requirements for the Eurasian market (Russia, Belarus and Kazakhstan) according to the **EAC** certificate.



ASSISTANCE/CONTACTS:



Headquarters:

Esa S.p.A.
Via Enrico Fermi 40
24035 Curno (BG) - Italy
Tel +39.035.6227411
Fax +39.035.6227499
esa@esacombustion.it

International Sales:

Pyronics International s.a.
Zoning Industriel, 4ème rue
B-6040 Jumet - Belgium
Tel +32.71.256970
Fax +32.71.256979
marketing@pyronics.be

www.esapyronics.com

ESA GENIO-S is a microprocessor flame control for the management and the control of single-stage burners in a condition of permanent operation, giving a simple and thorough status display of the burner.

The device has commands and local indications that together with the remote reset input and burner lockout output allow complete management of the burner.

ESA GENIO-S is supplied in a robust thermoplastic case designed for housing the ignition transformer and the connection cables, allowing installation in the immediate vicinity of the burner.

APPLICATION

- One-stage gas burners with continuous operation.
- Burners with detection electrode or single electrode, and combined together.
- Tunnel furnaces with local and remote control of the burners.

CHARACTERISTICS

GENERAL

- Supply voltage: 115 Vac / 230 Vac +10÷-15%
- Supply frequency: 45÷65 Hz
- Supply type: phase-neutral, not suitable for phase-phase systems
- Type of neutral: suitable for systems with both neutral to earth as well as non-earthed neutral
- Power consumption without load: 6 VA max
- Operating temperature: 0÷60 °C
- Storage temperature: -20÷80 °C
- Protection degree: IP40
(for wiring use specific cable glands)
- Mounting position: any
- Working environment: not suitable for explosive or corrosive environments
- Container: Thermoplastic with glass fiber
- Size: 200×120×98 mm
- Weight: 1.200 g



F7021103

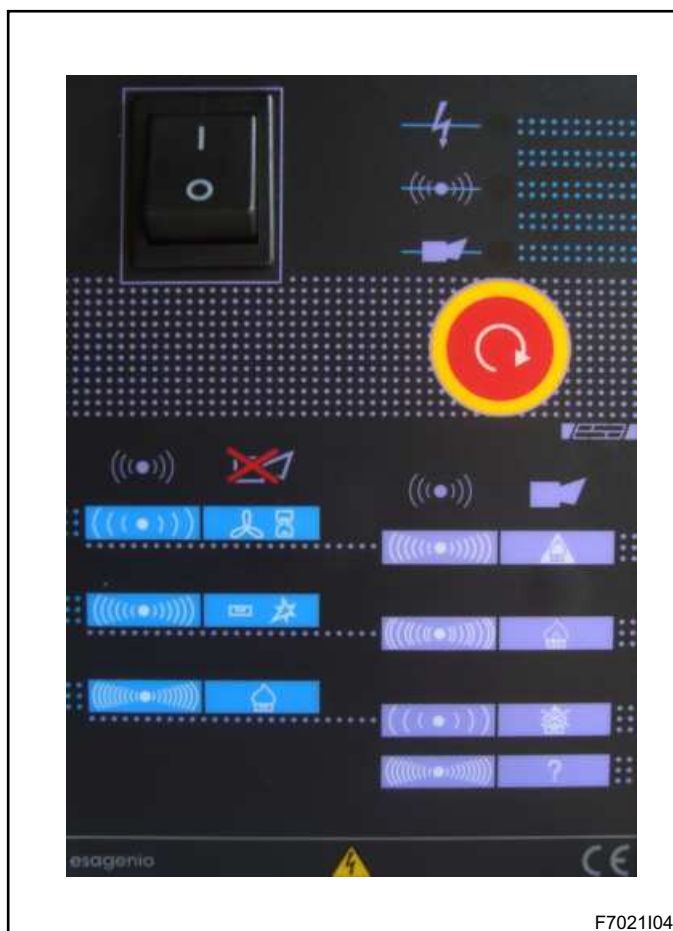

F7021104

CHARACTERISTICS

INPUTS AND OUTPUTS

■ Voltage at flame detection probe:	max 280 Vac
■ Minimum ionization current:	3 μ A \pm 0,3 μ A
■ Current limit on the probe:	1 mA
■ Type of detection probe:	electrode
■ Line length of detection electrode probe:	< 2 m
■ Insulation between probe conductors:	> 50 M Ω (cables with double insulation or protection)
■ HV cable length from ignition transformer:	ideal length 1 m / maximum 2 m
■ Distance between ignition electrode and burner mass:	3 mm \pm 0,5
■ Remote reset input voltage:	same as the supply voltage
■ Digital input absorption:	max 5mA
■ Output voltage:	same as the supply voltage
■ Maximum current for each output:	1,5 A (2 A for ignition transformer)
■ Total maximum current for all the outputs:	3.15A per 10 seconds / minute
■ Output protection fuse:	3.15A rapidly replaceable
■ Resistance outputs for burner counts	1,8 K Ω ¼ W 1%

PARAMETERS

■ Waiting or prepurge time before ignition:	0÷65 sec (multiples of 5 sec)
■ First safety time:	3-5-7-10 sec
■ Reaction time:	1 sec
■ Accepted remote unlocks:	max 5 in 15 minutes
■ Type of lockout:	volatile unlocking at the power supply
■ Flame sensor check on permanent operation:	within 1 hour

DESCRIPTION

ESA GENIO-S is a microprocessor flame control with inputs and outputs for the management and supervision of burners in permanent operation, suitable for applications in which the burners remain lit for periods longer than 24 hours. ESA GENIO-S manages one-stage gas burners, by detecting the flame presence via a dedicated

detection electrode or through the same electrode used for the ignition of the burner (single electrode), thanks to the ionization effect. The internal flame amplifier is checked every hour guaranteeing the functionality and safety for prolonged operating periods of the burner.

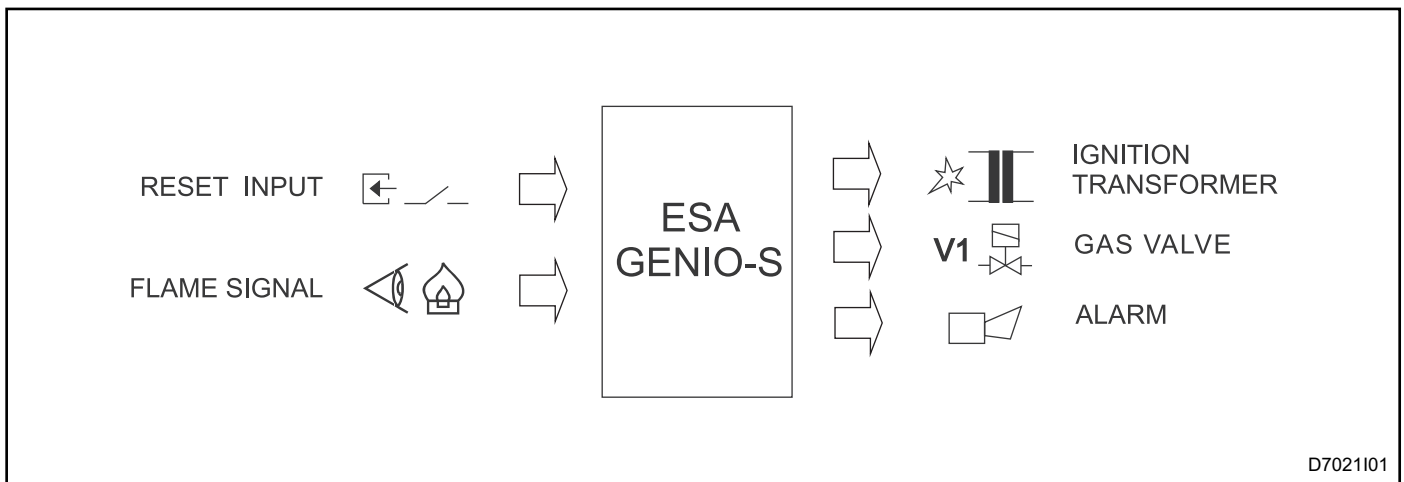

The device has a local switch for burner exclusion, a reset button and diagnostic leds.

ESA GENIO-S signals to the furnace control system that the burner is in lockout by closing a voltage free contact, or giving the status of the burner with no anomalies via an output with calibrated resistance that must be connected to a burner count system. Moreover, the device has a reset input to be able to accept the remote unlocks.

ESA GENIO-S allows to change the waiting time of igni-

tion and recycle even in the installation phase, while the safety and intervention times are fixed and can only be modified by the manufacturer.

The device is supplied in a robust housing made of thermoplastic designed for the outputs of the cables and for the housing of the ignition transformer. On request, ESA GENIO-S can be supplied pre-wired.

DISPLAY AND LOCAL CONTROL SECTION

DISPLAY SECTION





ESA GENIO-S has a display section composed of three Diagnostic LEDs, one of which regards the power supply

and the other two that combined indicate the different phases of the ignition cycle and the type of burner lockout.







SYMBOL	COLOUR	DESCRIPTION
	Green	Power Led, indicates that the ESA GENIO-S device is powered and controls the burner by managing the output of the gas valve and ignition transformer.
	Yellow	Status Led indicates, depending if blinking or steady, the operation state of the burner. Also in conjunction with the red Led runs a diagnostic on the type of burner lockout.
	Red	Lockout presence Led. Indicates that the device is in a lockout state due to the malfunctioning of the burner or one of its organs.

DISPLAY AND LOCAL CONTROL SECTION

Regular functioning phases

LOCKOUT LED	STATUS LED	DESCRIPTION
 off	 slow blinking	Counting stage of the waiting time before ignition of the burner. During this phase a check is carried out to make sure that there is no flame present, otherwise a lockout for illegal flame is determined.
	 fast blinking	Ignition phase of the burner with duration equal to the first safety time. The equipment activates the ignition transformer and the gas valve, then at the end of the safety time deactivates the transformer and verifies the flame formation.
	 on (steady)	ESA GENIO-S keeps active the gas valve and continuously checks the presence of the flame in the burner
	 off	Waiting phase before repeating the attempt to ignite the burner following the flame signal loss when the recycle is active. This stage lasts only a few seconds.

Lockouts or failures

LOCKOUT LED	STATUS LED	DESCRIPTION
 On (steady)	 slow blinking	Lockout due to loss of flame signal during the normal operation of the burner. The causes are to be found in the regulation of the flow of combustion air and fuel (rapid flow variations, adjustment out of range) or in the detection system (probes broken, dirty or poorly positioned).
	 fast blinking	Lockout due to the detection of a signal or illegal flame during the phases prior to ignition of the burner. The causes are to be found in the detection system (broken sensor) or in the gas drawn by the safety solenoid valve that allows the burner to remain on.
	 1 slow blinking and 2 rapid alternating	Lockout due to flame failure during burner ignition. The causes are to be found in the ignition system (absence of spark to the electrodes or faulty transformers), the incorrect adjustment of the fuel and combustion air flows, or in the detection system (broken sensor, broken wires, earthing not connected). Specifically, in the first two cases the flame does not trigger, while in the latter case the flame forms but ESA GENIO-S is not able to detect it.
 off	 on (fixed)	Generic lockout of the ESA GENIO-S device as a result of a malfunction detected in its internal components. Power cycle the device and if the problem persists, the instrument must be sent to the manufacturer.
	 fast blinking	Software lockout in which ESA GENIO-S maintains outputs inactive indefinitely. Blocking software happens as a result of attempts to reset in time lapses that are too close to each other. To restore operation turn off and then on again the device.

LOCAL COMMAND

ESA GENIO-S allows local control of the burner thanks to a reset button and a power switch. The button has the function of local unlocking and is active when the burner is in lockout state to the exclusion of the software lockout that requires to be switched off via

the power switch. Following burner lockout, wait 2 seconds before pressing the reset button. The power switch disconnects the flame control and in multi burner applications, allows you to select the ones to keep off or on depending on the production requests.

FUNCTIONING

ESA GENIO-S, when powered, it carries out burner ignition by activating the ignition transformer and the gas valve. After the ignition phase the device keeps active only the gas valve for the entire time in which the flame is present.

If the flame does not form or if it turns off during operation of the burner, the device intercepts the gas valve and displays the lockout status. If the recycle is activated, at flame signal loss, the device automatically performs a further ignition attempt.

To restore burner operation just press the front reset button or activate the remote input unlock or power cycle the device (automatic release at each feeding).

Before performing the attempt to light the burner ESA GENIO-S waits for the set waiting time, then moves on to the burner ignition. The power switch allows you to turn off the burner locally without the burner anomaly being reported to the control system.

The following table specifies the ignition sequence of the burner with an indication of the state of the outputs:

BURNER IGNITION CYCLE PHASE	GAS VALVE OUTPUT	IGNITION TRANSFORMER OUTPUT	OUTPUT WITHOUT ANOMALIES FOR BURNER COUNT	BURNER LOCKOUT OUTPUT
ESA GENIO-S off	Off	Off	Resistance on	Off
Purging phase according to the set time	Off	Off	Resistance on	Off
Ignition phase according to the set time	On	On	Resistance on	Off
Burner lit in regime	On	Off	Resistance on	Off
Recycle for flame loss	Off	Off	Resistance on	Off
Lockout for flame signal loss	Off	Off	Resistance off	On
Lockout for illegal flame before ignition	Off	Off	Resistance off	On
Lockout due to failed ignition	Off	Off	Resistance off	On
Generic device lockout	Off	Off	Resistance off	On

FUNCTIONING

Below you can see the burner ignition cycle performed by and subsequent unlock command.
 ESA GENIO-S, with flame signal loss after burner ignition

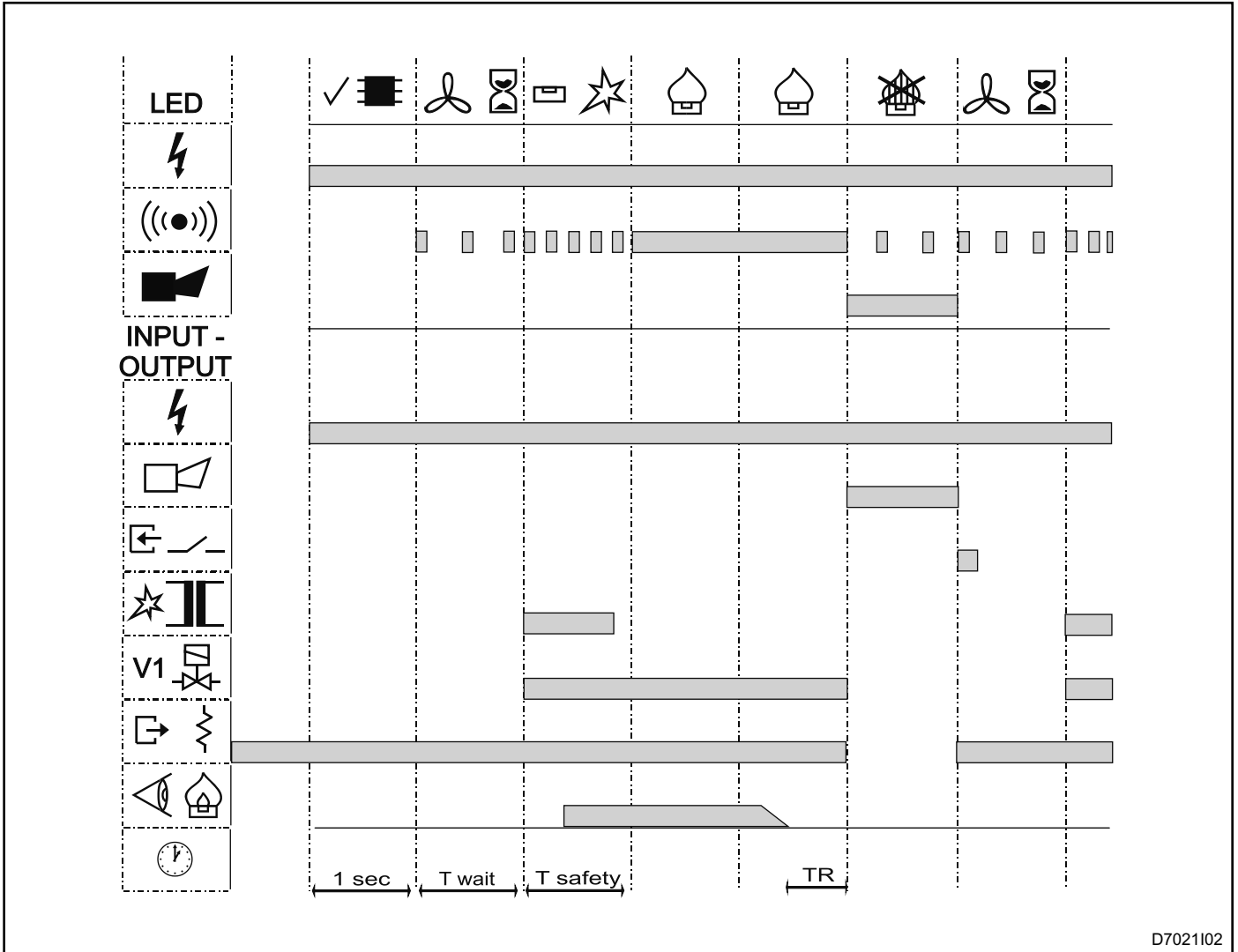

D7021102

APPLICATION EXAMPLE 1 - ESA GENIO-S

ESA GENIO-S manages a burner that has a specific electrode for ignition and another electrode for the detection of the flame signal.
The management system of the furnace feeds ESA

GENIO-S for controlling the ignition of the burner, receives a signal in case the burner is in lockout and may send a reset from the remote to retry ignition of the burner.

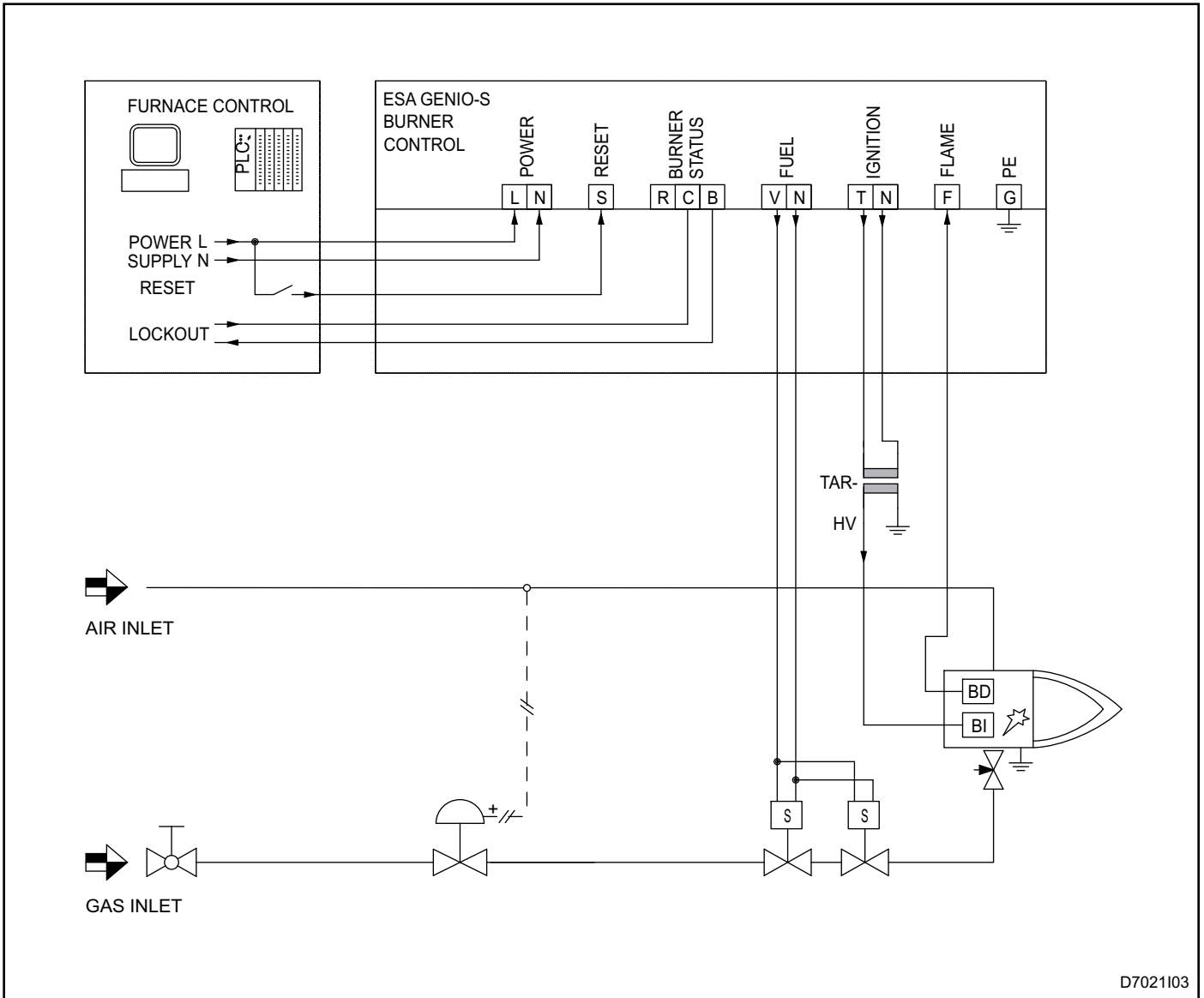

D7021I03

APPLICATION EXAMPLE 2 - ESA GENIO-S

ESA GENIO-S manages a burner that has a single electrode for ignition and flame signal detection. The management system of the furnace feeds ESA

GENIO-S for controlling the ignition of the burner, receives a signal in case the burner is in lockout and may send a reset from the remote to retry ignition of the burner.

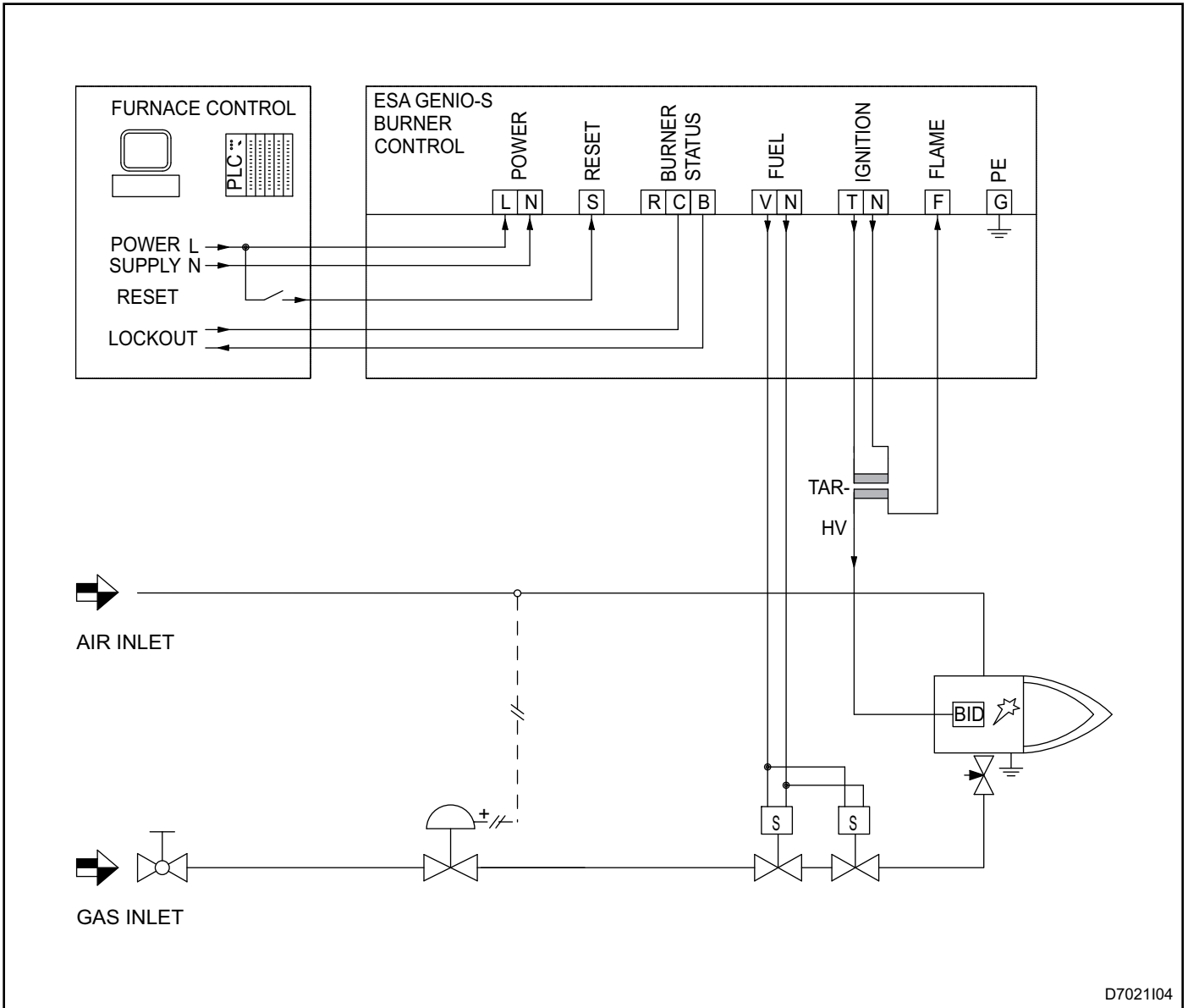

D7021104

CONFIGURATION PARAMETERS

The configuration defines the operating mode of ESA GENIO-S, adapting it to the needs of the system. The safety parameters are set by the manufacturer in accordance with the rules for application, so they cannot be

changed; while the ignition waiting time and the attempt for recycle due to the loss of the flame signal can be modified by the user using the dip-switches S1 to S5 (see letters on the board).

Enable / Disable Recycle



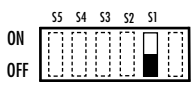
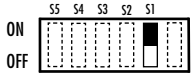



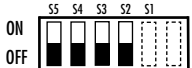
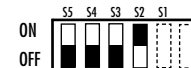

The attempt to recycle after the loss of the flame signal is enabled by putting the "ON" position on the dip S1. In case this dip-switch is in position 0, when the flame signal is lost, the device intercepts the gas valve and stops in lockout with the relative indication.

Recycle OFF	
Recycle ON	

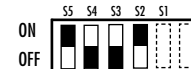
Purge time setting

The ignition waiting time is set via four DIP switches that combined together allow you to have a range from 0 to 65 seconds, as expressed in the following table. This

opportunity allows to start several burners in sequence even with a single ignition signal, or to change the waiting time during installation.

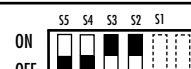
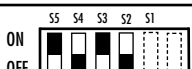
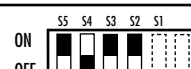
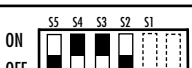
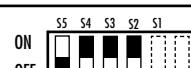
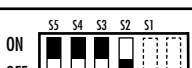
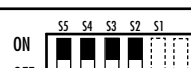
Waiting time: 0 sec.		Waiting time: 30 sec.	
Waiting time: 1 sec.		Waiting time: 35 sec.	
Waiting time: 3 sec.		Waiting time: 40 sec.	
Waiting time: 5 sec.		Waiting time: 45 sec.	
Waiting time: 10 sec.		Waiting time: 50 sec.	
Waiting time: 15 sec.		Waiting time: 55 sec.	
Waiting time: 20 sec.		Waiting time: 60 sec.	
Waiting time: 25 sec.		Waiting time: 65 sec.	

CONFIGURATION PARAMETERS

The following table shows the maximum time allowed for safety. Refer to the specific rule to determine the correct parameters applicable to the installation, choosing values that do not compromise safety.

If values are set that are not allowed by EN298 but only by EN746-2, on the label of the instrument only the reference standard for which ESA GENIO-S is applicable is indicated.

APPLICATION	NORM	IGNITION SAFETY TIME	REACTION TIME	NOTES
Gas burners	EN298	Refer to the application Norm	max.1 s	Recycle and reignition allowed.
	EN676	Dipends on burner type and power max. 5 s	max. 1 s	Depending on the application, only one recycle attempt is allowed. "Prepurge" mode is specified by the norm.
	EN746-2	Dipends on burner type and power max. 10 s	Depends on the application maximum 2 s	Depending on the application, one recycle attempt is allowed at flame signal loss, two recycle attempts at failed ignition and high temperature functioning. "Prepurge" mode is specified by the norm.
Oil burners	EN230	Dipends on burner type and power max. 20 s	max.1 s	Depending on the application, recycle and allowed reignition. "Prepurge" mode is specified by the norm.
	EN746-2	Dipends on burner type and power max. 10 s	Depends on the application maximum 2 s	Depending on the application, one recycle attempt is allowed at flame signal loss, two recycle attempts at failed ignition and high temperature functioning. "Prepurge" mode is specified by the norm.

WARNINGS

For a correct use of the flame control, follow these instructions:

- In the selection of configuration parameters to be analyzed, in addition to the standard specification, any risks associated with certain operating modes, choose values that do not compromise the safety of the application. Before installing the instrument, verify that the configuration parameters are set as defined.
- ESA GENIO-S is meant to be electrically connected in a permanent and fixed manner. The inversion of the phase/neutral connection may compromise the safety of the system. Do not use different phases between the different voltage inputs and do not apply voltages on the output terminals.
- Check the correct connection after installation. Before powering the instrument ensure that the voltage and frequency are correct. Ensure that loads do not have an absorption greater than the maximum capacity of the output contacts.
- The safety shutdown of the burner, for unsafe conditions for the application (emergency, temperature, pressure is not correct, etc) is only guaranteed by removing power from the device.
- The remote reset command must be impulsive: ESA GENIO-S accepts the unlock command when it receives the signal unless it has exceeded the number of unlocks allowed for the period of time.
- The power supply for fuel solenoid valves must be derived only from the predisposed ESA GENIO-S output. Management of the fuel solenoid valves using other devices (relay, not safety PLC...), which are commanded by the instrument is not admitted.
- When replacing the fuse outputs, the fuse must be fast blow and with a value that does not exceed the maximum permissible current.
- If there is trouble with other equipment (interference EMC) during the ignition of the burner, for the connection of the HV cable to the ignition electrode use a connector with noise filter (data sheet E5001), in addition to verifying that the path of the cable is correct (see "Installation" chapter), and that the cable is properly connected to the HV transformer and electrode connector.
- For single electrode detection systems use only specific ignition transformers, which allow the operation for ignition and detection with a single electrode. Check the correct connection of the protective earth to the device before ignition to avoid irreparable damage.
- Avoid burner ignition attempts close to each other so as not to overheat the control devices of the ignition system (solenoid valves and transformers). Consider a minimum time lapse between 1 ignition and another equal to the sum of the purging time and the first safety time, increased by 5 seconds.
- The remote signaling burner lockout should be used as an alternative to the output of the burner without anomalies with calibrated resistance connected to the burner counts system. You cannot use the two signals at the same time, since they have the same common terminal.
- In case of lockout or malfunctioning see chapter "Display Section" to identify the failure according to the code indicated by the instrument. Operate on the instrument and on the connected devices only when not powered.
- In case of malfunctioning ESA GENIO-S must be sent to the manufacturer for repair. Any modification or repair carried out by third parties causes the warranty conditions to automatically expire and may compromise the application safety.
- ESA GENIO-S is a control device of the safety organs and verifies the functionality of the burner (part of the protection system according to EN746-2). It is not intended as a regulation device, for which there are specific instruments.

INSTALLATION

For correct installation respect the following instructions:

- 1** - Avoid placing ESA GENIO-S near intense magnetic or electric fields. Do not expose to direct radiation from heat or products resulting from combustion such as liquids, solvents or corrosive gases.
- 2** - Do not limit in any way the area around the instrument, but leave enough space and ensure adequate ventilation to prevent overheating of the device.
- 3** - The installation should be performed by qualified personnel in compliance with the regulations in force at the time and place of installation.
- 4** - All processing of the container required for the installation of the instrument, must ensure a degree of protection equal to or not less than IP40. For systems used in open air the degree of protection should be equivalent to IP54. The degree of protection can also be guaranteed by the application in which the instrument is inserted.
- 5** - If the power system is the phase-phase type, you must install an insulation transformer connected to one end of the secondary winding referenced to ground.
- 6** - When wiring, refer to the technical documentation, according to the polarity between phase and neutral. The terminals for the electrical connections are screw type and can accept conductors of 0.5 to 2.5mm² and the choice of conductors and their location must be suitable for the application.
- 7** - Tighten adequately the conductors in the terminals to prevent malfunction or overheating which can lead to dangerous conditions. Numbering and the use of appropriate terminals on the conductors is recommended.
- 8** - The connection of the ignition transformer to its burner electrodes, must be done with unshielded HV (High Voltage) cable, specifically for high voltage (data sheet E5001). Use the connector with noise filter for connection to the ignition electrode. The length of the HV cable must not exceed the indicated size, otherwise the ignition transformer must be positioned near the burner. The HV cable must be routed away from power cables or signals and not in metal conduits: ideally it should be left in the open air. See data sheet E5004 for connection between the ignition transformer and its electrode on the burner.
- 9** - Make sure that the ignition electrode of the burner is positioned so that the distance between the terminal electrode and the metal mass, at the point of ignition burner, is less than the maximum allowed.
- 10** - The laying of the flame detection cables must be separated from power cables and other wires. The use of multi-core cables is not allowed and neither is the use of shielded cables. The type of cables must guarantee insulation between conductors as minimum required.
- 11** - The detection probes and any connectors must be isolated and out of reach by using protective gear to allow access only to authorized personnel; if it is considered necessary warnings must be placed close to the probes.
- 12** - Always make sure the protective earth conductor is connected with the respective suitable terminals, to all metallic frames and connected to the burner. The non-connection of the protective earth to the device, determines irreparable damage as well as a dangerous condition for the application and for the operator.
- 13** - At the end of the connections close the lid making sure that the conductors do not remain pressed between the cover and base.

BURNER START-UP

The operations indicated in the following chapter must be performed by expert technicians. Failure to follow instructions may cause dangerous conditions.

1 - Verify that ESA GENIO-S is installed and connected properly. Check that the wires are fully engaged in the terminals and that there are no uncovered conductor parts.

2 - Ensure that the grounding conductor is properly connected to the instrument, to the burner and all interconnected devices.

3 - The HV cable output from the ignition transformer must be sufficiently distant from metal masses and the device card, it also needs to be properly connected to the electrode of the burner. Verify that there are no unprotected metal electrode parts.

4 - Check that the distance between the terminal electrode and the metal mass, at the point of burner ignition, is less than the maximum allowed.

5 - Before powering the instrument ensure that the voltage and frequency are correct; ensure that users do not have an absorption greater than the maximum capacity of the output contacts.

6 - Following the previous checks, power the ESA GENIO-S using the front switch. The instrument will perform an attempt to ignite the burner. Visually check during ignition time that the electric arc is formed in the correct spot in the burner and that the flame lights.

7 - With the burner on, intercept the fuel through the manual valve and checking that ESA GENIO-S intercepts the fuel solenoid valve. Furthermore, the device should indicate the condition of the burner lockout, both locally via the LEDs as well as remotely when the output of the lockout is connected

8 - Re-open the manual fuel shut-off valve and give an unlock command, making sure that the instrument carries out the ignition cycle properly.

GENERAL MAINTENANCE PLAN

CHECK	TYPE	FREQUENCY	OPERATION
Closing of instrument	O	periodic	Check that the instrument is always closed to prevent dirt, dust and moisture from entering and damaging the device.
Connection cable integrity	O	every six months	Check the integrity of the outer insulation and the absence of abrasions or overheating of conductors.
Device response	O/S	annual	Check that the commands from the control system are carried out and that the status is reported correctly.
Device intervention	O/S	every six months	Check that the instrument deactivates the fuel solenoid valve as a result of a burner lockout.
Clamping of conductors	O/S	annual	Reduce to every six months for applications with vibrations.
Instrument replacement	S	/	Replacement is necessary if the device is no longer functioning.

NOTES:

Key: O = ordinary / E = extraordinary

ORDINARY MAINTENANCE

For proper maintenance of the ESA GENIO-S flame control, strictly follow the instructions. Before carrying out maneuvers with the system on, make sure that the safety of the process and the operator is not compromised, if necessary run checks with the system off.

CLOSING CHECK

■ The closure of the device is essential for its proper functioning as it prevents the entry of agents that might damage the control board. Ensure that the lid adheres to the base so that the seal is effective. If there is dirt inside, first disconnect the power supply from the device and then remove dirt by blowing with compressed air. Do not use any mechanical means for this operation.

INTEGRITY CHECK

■ The integrity of electrical cables can be checked visually. If you need to work on the conductors, due to the fact that they are not totally visible, disconnect the power to the device before attempting any changes.

DEVICE RESPONSE

■ Check that ESA GENIO-S commands burner ignition following the supply or unlock command from the furnace control remote system. With burner on, determine a lockout condition and verify that the instrument changes the status of the fault / burner lockout.

DEVICE INTERVENTION

■ With burner on, determine a burner lockout condition by closing the manual gas shut-off valve of the burner. Verify that ESA GENIO-S switches off the fuel solenoid valve within the set reaction time.

CONDUCTOR CLAMPING

■ Checking of the clamping of the conductors in the appropriate terminals is necessary to prevent malfunction or overheating. This applies both to the conductors connected to the terminal of the device as well as to those related to users. During this operation, also check that the insulation of the conductor arrives right into the terminal or the terminal block.

EXTRAORDINARY MAINTENANCE

For proper maintenance of the ESA GENIO-S flame control, strictly follow the instructions to be carried out with the system turned off.

INSTRUMENT REPLACEMENT

1 - Make sure that the device is the cause of the failure or improper operation and that you have a spare part identical to the one being replaced, verifying the data placed on the identification label.

2 - Turn off the power supply and unscrew the four fixing screws to remove the cover with the instrument. Unhook the quick connecting terminal from the card, leaving the wires connected to the female terminal block.

3 - Replace the instrument and insert the female terminal connected to the cables in the correct place on the new device, making sure that it is correctly inserted and not overturned or shifted.

4 - Close the new instrument on the existing base making sure that the wires do not remain pressed between the cover and base.

5 - Verify that the new instrument is working properly. Repeat all steps in "BURNER START-UP".

ESA GENIO-S CONNECTIONS

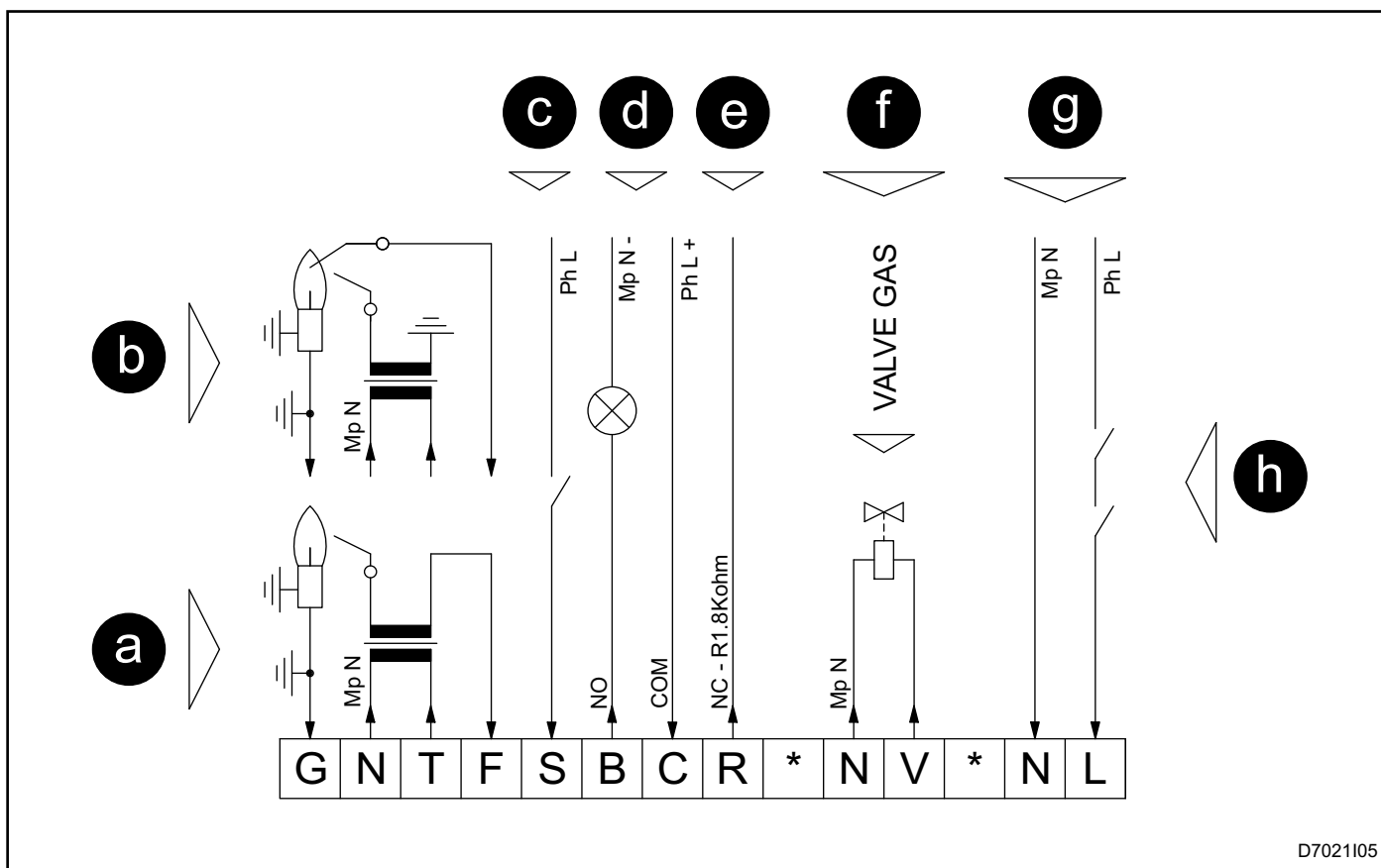

D7021I05

Pos.	Description	Pos.	Description
a	Unirod flame detection	e	Output with no anomalies with calibrated resistance (CR)
b	Flame detection with dedicated electrode	f	Gas solenoid valve
c	Remote reset input	g	Electric power supply
d	Output for burner in lockout with volt free contact (C-B)	h	Safety stop

TERMINAL CONNECTORS

Pos.	Description	Pos.	Description
G	Grounding PE protection and burner frame	R	Output for burner count (1.8Kohm resistance) for absence of anomalies.
N	Ignition transformer neutral	*	Not connected
T	Ignition transformer phase	N	Neutral for 1st stage gas solenoid valve
F	Detection electrode or flame signal transformer (unirod)	V	Phase for 1st stage gas solenoid valve
S	Remote reset input	*	Not connected
B	Output for burner in lockout (N.O.)	N	Power supply neutral
C	Common for lockout output or output burner count	L	Power supply phase

OVERALL DIMENSIONS

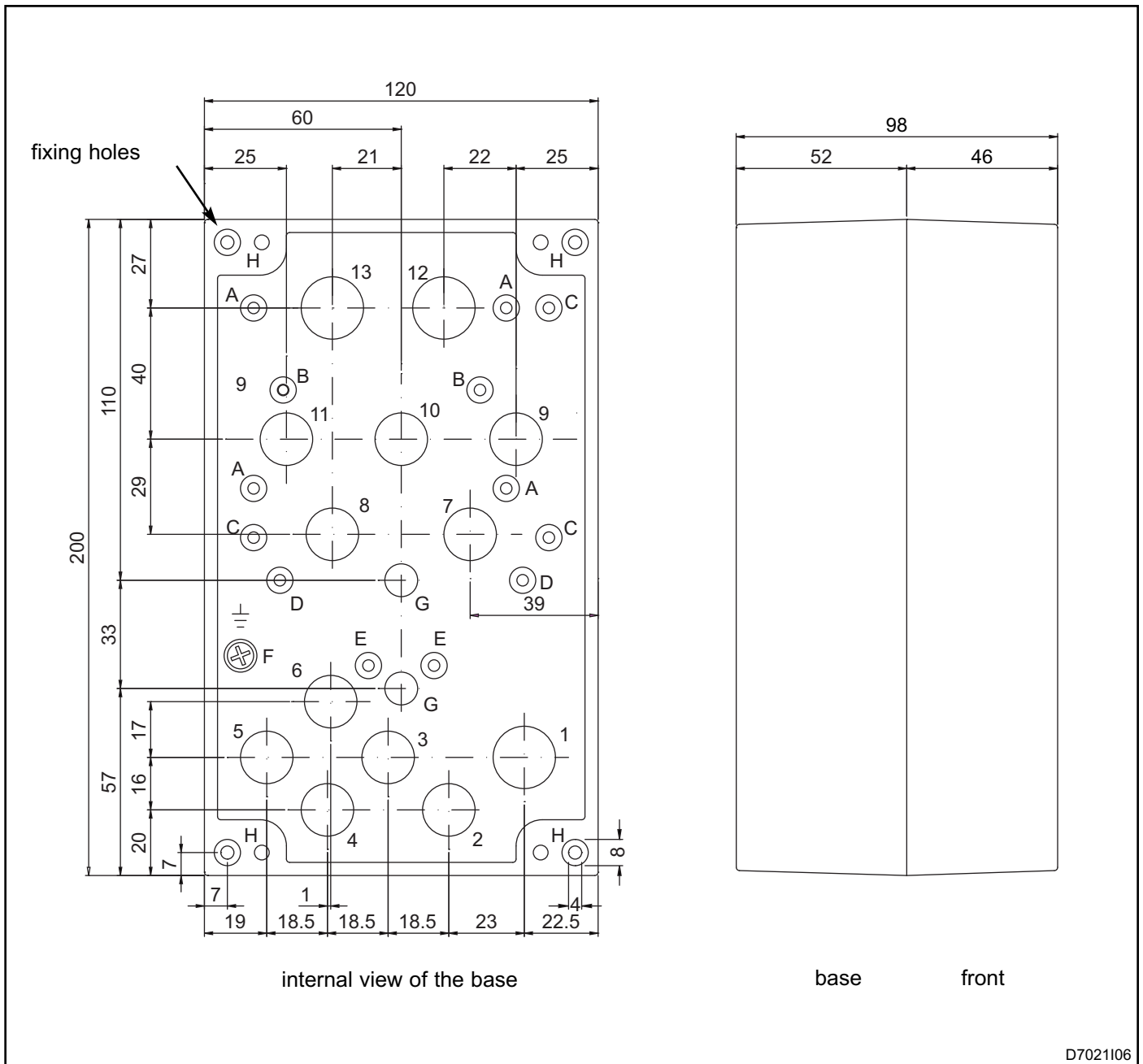

Preformed holes	Diameter mm	Cable gland
1	19	PG11 - M20x1,5
2-3-4-5-6	16	PG9 - M16x1,5
7-8-9-10-11 *	16	PG9 - M16x1,5
12-13 *	19	PG11 - M20x1,5

* The transformer mounting precludes the possibility of using hollow passages 7+13.

Pos.	Elements
A	Attachments for fixing the transformer
B	Attachments for fixing the transformer
C	Not used
D	Not used
E	Not used
F	Screw support for earthing
G - G	Mounting plate or rear collar (tube 1/2 ") - Tapping

ORDERING CODE

ESA GENIO-S

01	02	03	04	05	06	07
----	----	----	----	----	----	----

CYCLE START 01	
Automatic start (auto start)	A

PREPURGE-WAITING TIME 02	
from 0 to 65 seconds see configuration parameters pag. 11	(_ _)*

1ST SAFETY TIME 03	
3 seconds	03
5 seconds	05
7 seconds	07
10 seconds	10

1st GAS STAGE OUTPUT TYPE 04	
Intermittent (continuous)	C

05 BEHAVIOUR AT FLAME FAILURE	
Stop in lockout	N
Starts recycle	Y

06 SUPPLY VOLTAGE	
115 Vac	115
230 Vac	230

07 SPECIAL VERSION	
Standard	/
ignition transformer inside	T
Pre wiring	C
ESA TRAF0 coupled with	A

(*) Enter value in seconds in three digits (ex. 001), see section "Configuration Parameters" page 11