



TT 49

MICROPROCESSOR-BASED DIGITAL ELECTRONIC TIMER



User Manual

Cod.: ENG - Vr. 04 - 17/11 - ISTR-MTT49E04

ASCONECNOLOGIC S.r.l.

Viale Indipendenza 56, 27029 - VIGEVANO (PV) ITALY

TEL.: +39 0381 69871 - FAX: +39 0381 698730

<http://www.ascontecnologic.com>

e-mail: info@ascontecnologic.com

PREFACE



This manual contains the information necessary for the product to be installed correctly and also instructions for its maintenance and use; we therefore recommend that the utmost attention is paid to the following instructions and to save it.

This document is the exclusive property of Ascon Tecnologic S.r.l. which forbids any reproduction and divulgation, even partially, of the document, unless expressly authorized.

Ascon Tecnologic S.r.l. reserves the right to make any formal or functional changes at any moment and without any notice. Ascon Tecnologic S.r.l. and its legal representatives do not assume any responsibility for any damage to people, things or animals deriving from violation, wrong or improper use or in any case not in compliance with the instrument features.



Whenever a failure or a malfunction of the device may cause dangerous situations for persons, thing or animals, please remember that the plant has to be equipped with additional devices which will guarantee safety.

Index

1. Instrument description	1
1.1 General description.....	1
1.2 Front panel description	2
2. Programming	2
2.1 Set points programming.....	2
2.2 Parameters programming	2
2.3 Parameters Lock	2
3. Use warnings	2
3.1 Allowed Usage	2
4. Installation warnings	2
4.1 Mechanical Mounting.....	2
4.1.1 Instrument dimensions	3
4.1.2 Panel cutout.....	3
4.1.3 Mounting brackets	3
4.2 Electrical connections	3
4.2.1 Electrical connection diagram.....	3
5. Operating mode	3
5.1 Operating commands.....	3
5.2 Display functioning.....	3
5.3 OUT1 Operating mode.....	4
5.4 OUT2 Operating mode.....	4
5.5 CNT EN Input operating mode.....	5
6. Programmable parameters	6
6.1 Parameters table.....	6
6.2 Parameters description	6
7. Problems, maintenance and warranty	7
7.1 Cleaning.....	7
7.2 Warranty and repairs.....	7
7.3 Disposal	7
8. Technical data	7
8.1 Electrical data	7
8.2 Mechanical data.....	7
8.3 Functional data	7
9. Instrument order code	8

1. INSTRUMENT DESCRIPTION

1.1 General description

TT 49 is a programmable microprocessor based timer with **1 or 2 outputs**.

The instrument offers the possibility to program: up to **3 Set Point times**, **5 operating modes** for output **OUT1**, **4 operating modes** for output **OUT2**, **4 time scales** (from 9999 h maximum to 0.1 s minimum), **4 functioning modes** of counting enable and **2 counting modes (UP/DOWN)**.

Inside the instrument can be installed an optional back up battery which allows the counting also without power supply.

The counting state is displayed on a **4 digits display** while the outputs state is indicated by **2 LEDs**.

The instrument can have **2 outputs (relay or voltage output to drive solid state relays)** and **2 digital inputs** for free of voltage contacts and devices with NPN transistor outputs (Order Code **b = C**) or voltage inputs (the same voltage supply value)(Order Code **b = V**). The 2 digital inputs are used to enable counting (**CNT EN**) and reset (**RES**).

The instrument can be programmed using the keys placed on the front panel while the **Start** count command can be submitted with the key **U** or using the digital inputs **CNT EN** and **RES** connected in the back of the instrument.

1.2 Front panel description

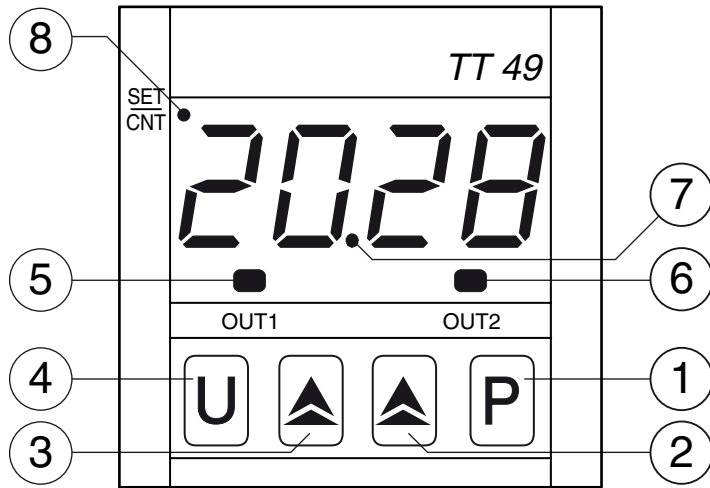

1. **P**: Used for the set point setting and to program the functioning parameters;
2. **▼**: Used to decrease the values or to select parameters;
3. **▲**: Used to increase the values or to select parameters;
4. **U**: Used to Start, Stop or reset the count;
5. **LED OUT1**: Indicates when the output **OUT1** is **ON** or **OFF**;
6. **LED OUT2**: Indicates when the output **OUT2** is **ON** or **OFF**;
7. **Decimal Point**: Indicates the separation between hours and minutes, minutes and seconds or seconds and cents;
8. **SET/CNT LED**: Indicates the set point or the **parameters programming mode** (flashing fast), the **count ON** (flashing each second), the **count stopped** (ON) or **reset mode** (OFF).

2. PROGRAMMING

2.1 Set points programming

The instrument allows to program up to 3 time sets: t_1 , t_2 , t_3 . To program this times proceed as follows:

- Stroke the **P** key and keep it pushed for about 1 s, the display shows t_1 and LED SET/CNT blinks rapidly. When the **P** key is released, the display shows alternatively t_1 and the value programmed for time t_1 . To modify the t_1 value, press the **▲** key to increase it or the **▼** key to decrease it.
- If the selected operating mode requires to set the t_2 time ($F_1 = 3, 4$ or 5), press the **P** key again (within 5 s), the display shows t_2 . When the **P** key is released, the display shows alternatively t_2 and its value. To modify the t_2 time value, use the keys **▲** or **▼**.
- If the selected operating mode requires to set the t_3 time ($F_2 = 3$ or 4), press the **P** key again (within 5 s), the display shows t_3 . When the **P** key is released, the display shows alternatively t_3 and its value. To modify the t_3 time value, use the keys **▲** or **▼**.

To exit the Set Point programming mode, press no keys for about 5 s or press the **U** key once, the display returns to the counting value.

Set times programming is always possible, with count ON and OFF.

2.2 Parameters programming

To access the functioning parameters, press the **P** key and keep it pressed for about 5 s at the end of which the instrument shows the label of the first programmable parameter F_1 .

Releasing the **P** key the instrument shows alternatively the label F_1 and the value programmed for t_1 which can be modified with the **▲** or **▼** keys. Once the desired value has been programmed, press the **P** key again, the instrument shows the label of the next parameter.

Releasing the **P** key, appears the value programmed for that parameter which can be modified using the **▲** or **▼** keys.

Pushing and releasing key **P** it is possible to scroll all the parameters labels (when the **P** key is pushed) and the relative programming (when the **P** key is released) one after the other.

To exit the parameters programming mode, press **NO KEYS** for about 20 s or press the **U** key once, the display returns to the counting value.

Note: The parameters programming mode can be accessed only while the count is stopped.

2.3 Parameters Lock

It is possible to lock the access at the programming parameters using the following procedure :

- Switch OFF the instrument, press key **P** and keep it pressed while the instrument is powered ON again;
- After about 3 s on the display appears the software release number, the after 2 s on the display appears $\cup L$ (unlock) that indicates that the parameters are accessible;
- While the **P** key is pressed, press also the **▼** key, the instrument displays $L \square$ (lock) to specify that the parameters are not accessible;
- Release key **P** to exit from this procedure;
- The display returns to the normal functioning, the parameters will not be accessible anymore and it will only be possible to modify the Set Points;
- To access the parameters again, repeat the same procedure pressing the **▲** key to select $\cup L$, at the end exit the parameters lock modality.

3. USE WARNINGS

3.1 Allowed Usage



The instrument has been projected as measure and control device, built according to EN61010-1 for the altitudes operation until 2000 ms.

The use of the instrument for applications not explicitly allowed by the above mentioned rule has to foresee proper protection devices.

The instrument **MUST NOT** be used in environments with dangerous atmosphere (flammable or explosive) without a proper protection.

It has to be reminded that the user has to take care that the electromagnetic rules are being respected also after the instrument installing, eventually using proper filters.

4. INSTALLATION WARNINGS

4.1 Mechanical Mounting

The instrument, in case 48 x 48 mm, is designed for flush-in panel mounting. Make a hole 45.5 x 45.5 mm and insert the instrument, fixing it with the provided special bracket(s).

To obtain the declared protection degree (IP65), in addition to the gasket, the screw type bracket must be used (see the “**9. Instrument order code**” paragraph for details).

- Avoid to install the instrument in places with very high hu-

midity or dirt that may create condensation or introduction into the instrument of conductive substances.

- Ensure the adequate ventilation to the instrument and avoid the installation within boxes where are placed devices which may overheat or have as a consequence the instrument functioning at temperature higher than allowed and declared.
- Connect the instrument as far as possible from source of electromagnetic disturbances so as motors, power relays, relays, electrovalves, etc..

4.1.1 Instrument dimensions

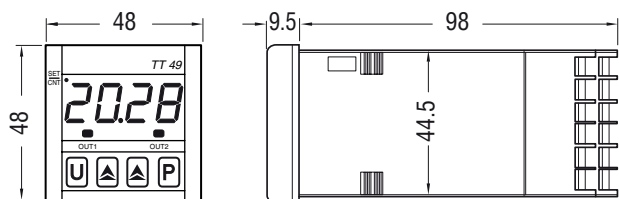

4.1.2 Panel cutout

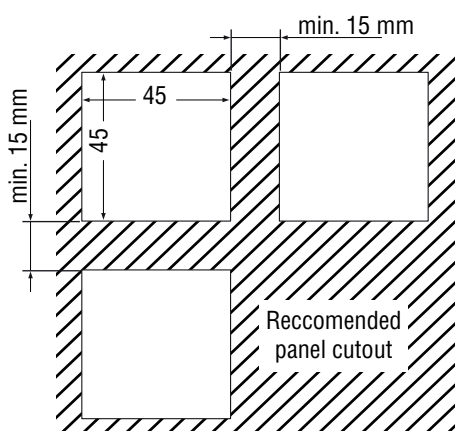

4.1.3 Mounting brackets

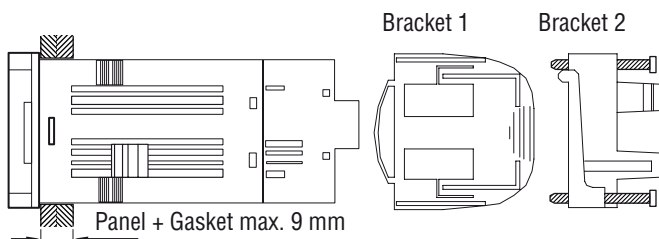

The instrument electronics can be extracted from the front side of the housing: prior to extract the instrument from the housing, disconnect the power supply.

4.2 Electrical connections

Carry out the electrical wiring connecting only one wire for each terminal, according to the following diagram, checking that the power supply is the same as indicated on the instrument and the loads current is not higher than the maximum current admitted.

The instrument, being a built in equipment with permanent connection into a cabinet, is not equipped neither with switches nor with internal devices protecting it from overcurrents: it is therefore recommended to provide for the installation of a two-phase circuit-breaker placed as near as possible to the instrument, located in a position easily reachable by the user and marked as instrument disconnecting device. It is furthermore recommended to properly protect all the electric circuits connected to the instrument, with devices (ex. fuses) proportionate to the circulating currents.

It is strongly recommended to use cables with proper insulation, according to the working voltages and temperatures and to separate the control signal cables from the line voltage wiring. When you choose the b parameter with option 2 (timer continues operating in case of power failure) is necessary to check that the internal battery is present and enabled. In order to extend battery life, it is recommended to disconnect the battery when it is not necessary for operation. Finally, it is advisable to check that the parameters are those desired before connecting the outputs to the actuators in order to avoid plant anomalies which may cause injuries to people, things or animals.

4.2.1 Electrical connection diagram

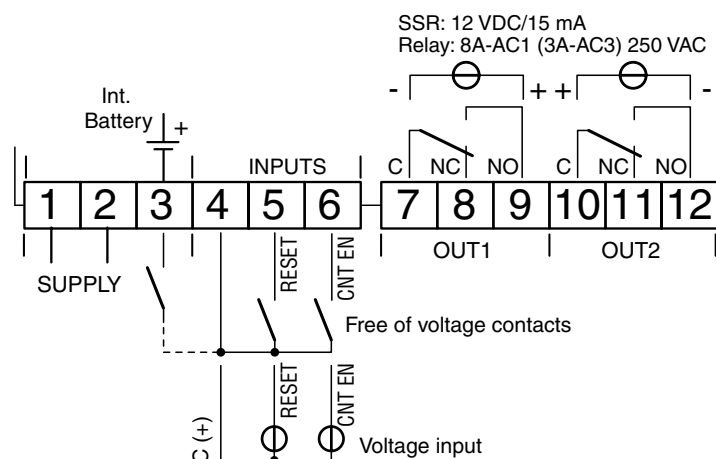

5. OPERATING MODE

5.1 Operating commands

The counting can be enabled and disabled through the \square key or through the remote inputs **CNT EN** and **RES**.

The operating mode of the \square key is defined by the parameter " ε ", the operating mode of the input **CNT EN** is defined by the parameter " ε " while the **RES** input always works as **reset**, i.e. it stops and resets the counting when is active and moreover it has the priority on the other commands (when **RES** is active it does not allow the count Start).

When the installation is planned to allow the timer functioning during the power failures, during the power down conditions the only active command is the **Reset** that can be submitted using the \square key.

For this reason, when the instrument is supplied through the battery, it is not possible re-start the counting once it has been stopped.

5.2 Display functioning

The LED **SET/CNT** is used to indicate the access in **programming mode** (flashing fast), the **count in action** (flashing each second), the **count interrupted before the term** (lighted fixed) or the **count finished and Reset status** (OFF). After the Reset, the display shows $\square\square\square\square$ when the counting mode is programmed as **UP** (parameter $\varepsilon = 1$) or displays the programmed time value if the counting mode is programmed as **DOWN** (parameter $\varepsilon = 2$).

While the timer is functioning, the display shows the value of the elapsed time in **UP** or in **DOWN** mode.

If the back-up mode has been programmed to continue the counting in action in case of power failure, the display remains lighted but using a lower brightness with the purpose to limit as much as possible the battery consumption.

5.3 OUT1 Operating mode

The instrument can be programmed by the parameter $F1$ to operate in any of the following 5 modes:

F1 = 1 - Delayed:

Timing begins at the leading edge of the **Start** signal. The control output **OUT1** will be energized when the present value equals the $t1$ preset time. The output is sustained until a **Reset** signal is applied.

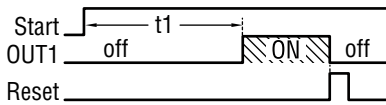

F1 = 2 - Feedthrough:

Timing begins at the leading edge of the **Start** signal. The control output **OUT1** is energized only during timing (the output is disabled when the set time value $t1$ has been reached). The output will be enabled again after a **Reset** and a subsequent **Start** signal have been received.

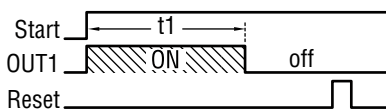

F1 = 3 - Asymmetrical oscillator with start in ON:

This operating mode allows the user to enter two Set times $t1$ and $t2$, and therefore also involves the $S2$ parameter. The **ON/OFF cycle** is initiated at the leading edge of the **Start** signal. The control output **OUT1** is immediately enabled and remains **ON** for the $t1$ preset time, then the output is disabled and remains disabled for the time period $t2$. This procedure continues until a **Stop/Reset** signal is received. $t1$ is the **ON time** and $t2$ is the **OFF time**.

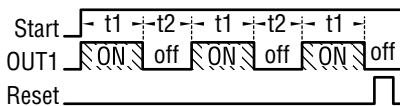

F1 = 4 - Asymmetrical oscillator with start in OFF:

This operating mode allows the user to enter two Set times $t1$ and $t2$, and therefore also involves the $S2$ parameter. The **OFF/ON cycle** is initiated at the leading edge of the **Start** signal. The control output **OUT1** remains **OFF** (disabled) for the $t1$ preset time, then **OUT1** is enabled and remains **ON** (enabled) for the time period $t2$. This procedure continues until a **Stop/Reset** signal is received. $t1$ is the **OFF time** and $t2$ is the **ON time**.

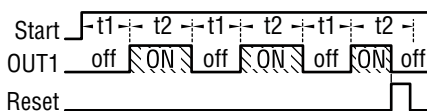

F1 = 5 - One cycle asymmetrical oscillator with start in OFF:

The operation is similar to the previous one ($F1 = 4$) with the only difference that **only one OFF/ON cycle** is performed. The **OFF/ON cycle** is initiated at the leading edge of the **Start** signal. The control output **OUT1** remains **OFF** (disabled) for the $t1$ preset time, then **OUT1** is enabled and remains **ON** (enabled) for the time period $t2$. The cycle will be enabled again after a **Reset** and a subsequent **Start** signals have been received.

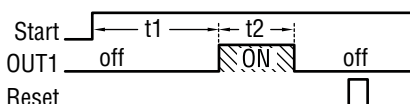

5.4 OUT2 Operating mode

The instrument can be programmed by the parameter $F2$ to operate in any of the following 4 modes:

F2 = 1 - Output **OUT2** operates like **OUT1**:

Output **OUT2** operates in the same way as output **OUT1** in order to give the user two output contacts.

F2 = 2 - Output **OUT2** operates as an instant contact:

OUT2 is activated during the counting phase and remains active until a **Reset** signal is received.

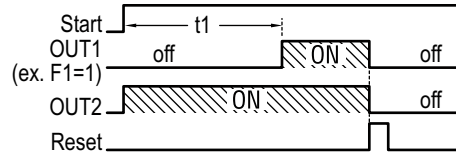

F2 = 3 - Same function of **OUT1** (time $t1$) with time $t3$ absolute:

The choice of this mode of operation enables the Set time $t3$ that has the same $S1$ range time and cannot be higher than $t1$. Timing begins at the leading edge of the **Start** signal, the instrument operates on output **OUT2** in the same way $F1$ operates on the output **OUT1**. If $F1 = 1, 4$ or 5 output **OUT2** operates with Delayed function: is enabled when $t3$ is expired while if $F1 = 2$ or 3 output **OUT2** operates with feedthrough function: is immediately enabled and disabled at the end of time $t3$. While programming $t3$ time the display shows $t3$ (t3 i) to indicate that the time $t3$ is independent.

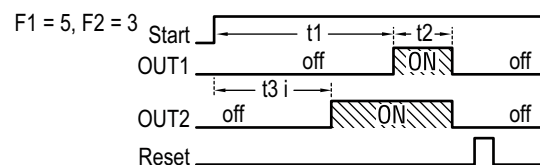
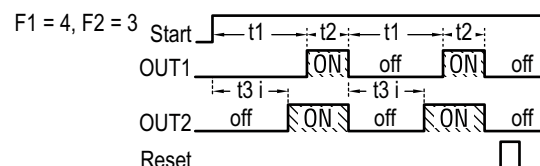
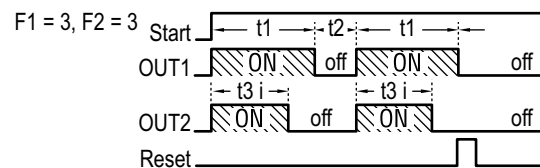
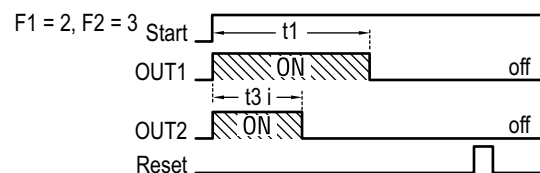
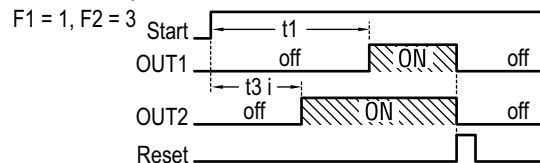

F2 = 4 - Same function of OUT1 (time t_1) with time t_3 relative to t_1 (in advance):

The choice of this mode of operation enables the Set time t_3 that has the same S_1 range time and cannot be higher than t_1 . Timing begins at the leading edge of the **Start** signal, the instrument operates on output **OUT2** in the same way F_1 operates on the output **OUT1**.

If $F_1 = 1, 4$ or 5 output **OUT2** operates with Delayed function with $[t_1 - t_3]$ delay while if $F_1 = 2$ or 3 output **OUT2** operates with feedthrough function with $[t_1 - t_3]$ delay. While programming t_3 time the display shows $t_3 d$ ($t_3 d$) to indicate that the time t_3 depends on the value of t_1 .

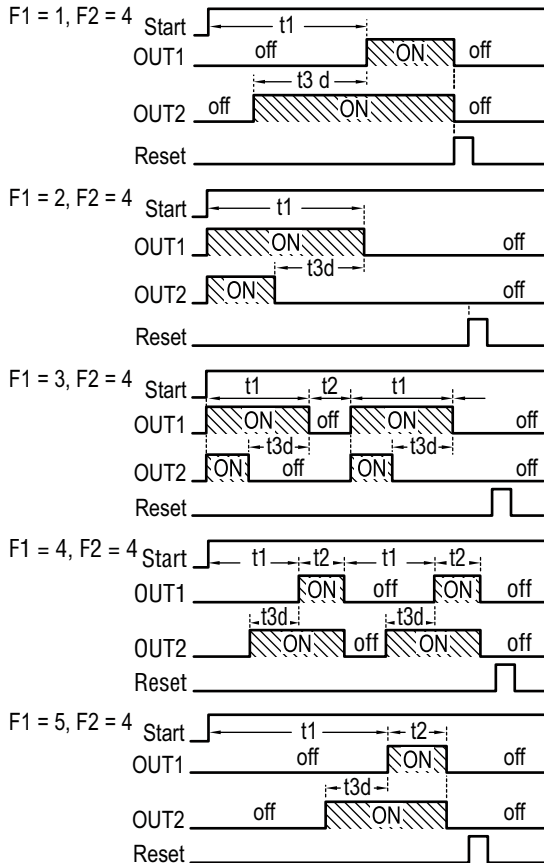

If $F_2 = 0$ the output **OUT2** is always disabled.

5.5 CNT EN Input operating mode

The Start signal can be given by the \square key programmed as **Start/STOP** ($t = 1$ or 2), which normally has a bistable (toggle) functioning, or by the count enable digital input (**CNT EN**). The **CNT EN** input can be programmed through parameter E to operate in any of the following 4 (5) modes:

E = 1 - Bistable (toggle) Start/STOP:

Closing (even temporarily) the **CNT EN** input is possible to **start** the timer. When the contact is closed again, the timer **stops** on the **current counting value**. The timer starts counting again at the next closure of the **CNT EN** input. This procedure continues until a **Reset** signal is received or the **Set time period** has **expired**.

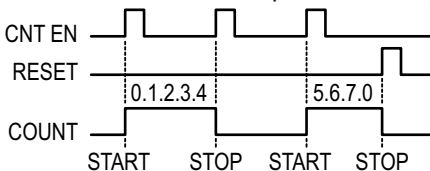

E = 2 - Bistable (toggle) Reset-Start/STOP:

This operating mode is very similar to the one of the \square key and depends also from t parameter which has 2 possible functioning modes:

E = 2, t = 1 - Reset-Start/STOP:

The first **CNT EN** impulse resets and starts the timer then, if the second impulse arrives before the end of the count, the timer stops (if the output was enabled, it will be disabled), otherwise, if the second impulse arrives after the end of the count, it activates a new counting cycle.

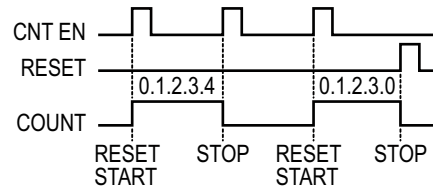

E = 2, t = 2 - Reset/Start/STOP:

At the **first** impulse on **CNT EN** input the timer is **Reset**, at the **second** impulse it **Starts** counting, at the **third** impulse the counting is **stopped**, and so on.

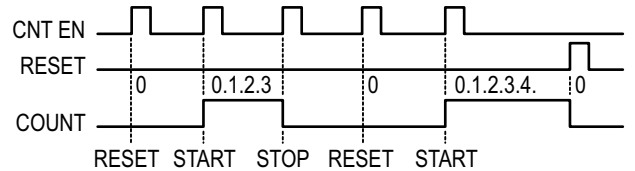

E = 3 - Monostable Start/STOP:

After being reset by means of the **Reset** input, the timer starts when the **CNT EN** contact is closed and stops when the contact is opened. At this point, if the contact is closed again, the count re-starts from the current value and so on until a **Reset** signal is received or the Set time period has expired. In this functioning mode the \square key works only as **Reset**.

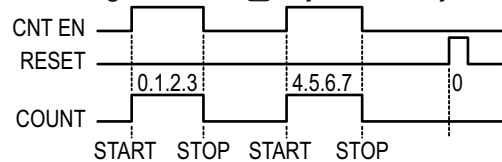

E = 4 - Monostable Reset-Start/STOP:

By closing the **CNT EN** input and keeping it closed, the timer Resets and Starts counting, at the opening of the **CNT EN** input the counting Stops. This operating mode is recommended when the user wants to control the timer using voltage signals. In fact, with an appropriate interface (e.g. an external relay) the timer resets and starts counting when voltage is supplied then stops when voltage is cut off (just like a conventional timer). In this functioning mode the \square key works only as **RESET**.

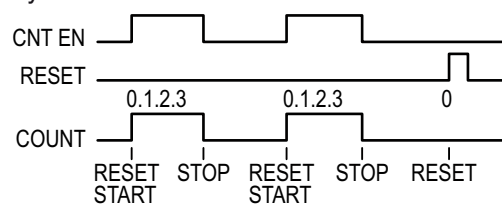

6. PROGRAMMABLE PARAMETERS

6.1 Parameters table

Par.	Description	Range	Def.
1	$F1$ OUT1 operating mode	1 - 2 - 3 - 4 - 5	1
2	$F2$ OUT2 Operating mode	0 - 1 - 2 - 3 - 4	0
3	$S1$ Time Range $t1$	1 - 2 - 3 - 4	1
4	$S2$ Time Range $t2$	1 - 2 - 3 - 4	1
5	$H1$ Maximum set time $t1$	00_ _ ... 99_ _	99_ _
6	$H2$ Maximum set time $t2$	00_ _ ... 99_ _	99_ _
7	C Counting mode	1 - 2	1
8	b Back-up mode	1 - 2 - 3	1
9	E CNT EN input operating mode	1 - 2 - 3 - 4	1
10	t U key operating mode	0 - 1 - 2 - 3	1

6.2 Parameters description

F 1 **OUT1 Operating mode:**

Allows the user to select the operating mode of **OUT1** output in relation to the count. The 5 modes are:

- 1 Delayed;
- 2 Feedthrough;
- 3 Asymmetrical Oscillator with Start in ON;
- 4 Asymmetrical Oscillator with Start in OFF;
- 5 One cycle Asymmetrical Oscillator with Start in OFF.

F 2 **OUT2 Operating mode:**

Allows the user to select the operating mode of **OUT2** output in relation to the count. The 5 modes are:

- 0 Output disabled;
- 1 Operates like **OUT1**;
- 2 ON during counting;
- 3 Same function as **OUT1** with time $t3$ absolute;
- 4 Same function as **OUT1** with time $t3$ realtive (dependent) from time $t1$.

S1 **Time range $t1$ (and $t3$):**

Allows the user to select the range and units of Set time $t1$ (and $t3$ when active) according to the following options:

- 1 hours (9999);
- 2 hours - minutes (99 h 59 min);
- 3 minutes - seconds (99 min 59 s);
- 4 seconds - hundredths of a second (99 s 99 1/100s).

S2 **Time range $t2$:**

This parameter only involves the operating modes $F1 = 3$ and 4 and is used to select the time range of the Set time $t2$ period. The options are the same as for the $S1$ parameter.

H1 **High set point time $t1$:**

Allows the user to program the max. value of the 2 most significative digits of Set time $t1$.

H2 **High set point time $t2$:**

Similar to **H1** but referred to the Set time $t2$.

C **Counting mode:**

Allows to choose the **UP** or **DOWN** counting mode, i.e. whether the display must show the elapsed or the remaining time. The options are:

- 1 **UP** mode (elapsed time);
- 2 **DOWN** mode (remaining time).

b **Back-up Mode:**

This parameter determines the instrument action in the case of power failure. The options are:

- 1 Timer stops and stores the counting current value;
- 2 Timer continues counting (only with external battery connected);
- 3 Timer resets the counting.

When option **1** is selected, the instrument goes OFF and the current counting value is saved. When the power supply is restored, the timer can re-start working from the saved value.

When option **2** is selected, in case of power failure the output goes OFF, but the timer continues counting. Note that mode **2** is enabled only when the internal battery is present and enabled. Under these conditions of operation the display is ON but with a brightness lower than in normal mode. Disconnect the battery when it is not necessary to operation.

When option **3** is selected, if a power failure happens, the instrument stops the counting and does not store the current counting value, so that when the power supply returns, the instrument will be in **Reset** conditions.

E **CNT EN Input operating mode:**

This parameter allows to select the operating mode of the Count Enable (**CNT EN**) external input.

The options are:

- 1 Bistable Start/Stop;
- 2 Bistable Reset-Start/Stop;
- 3 Monostable Start/Stop;
- 4 Monostable Reset-Start/Stop.

t **U Key operating mode:**

This parameter permits to decide the operating mode of the **U** key. The possible chooses are:

- 0 Key disabled;
- 1 Reset-Start/STOP;
- 2 Reset/Start/STOP;
- 3 Reset only.

7. PROBLEMS, MAINTENANCE AND WARRANTY

7.1 Cleaning

It is recommended to clean the instrument only with a cloth wetted with water or with a detergent neither abrasive nor containing solvents.

7.2 Warranty and repairs

The instrument is under warranty against construction vices or defected material, noticed within 18 months from delivery date. The warranty is limited to the repairs or to the substitution of the instrument. The eventual opening of the housing, the violation of the instrument or the wrong use and installation of the product means the automatic decay of the warranty. In case of defected instrument, noticed in warranty period or out of warranty, do contact our sales department to obtain the shipment authorisation.

The defected product must be shipped to Ascon Tecnologic with the detailed description of the failures found and without any fees or charge for Ascon Tecnologic, safe different agreements.

7.3 Disposal



The appliance (or the product) must be disposed of separately in compliance with the local standards in force on waste disposal.

8. TECHNICAL DATA

8.1 Electrical data

Power supply: 12 VDC/VAC, 24 VAC/VDC, 100... 240 VAC $\pm 10\%$;

Frequency AC: 50/60 Hz;

Power consumption: 2 VA approx.;

Inputs: 2 digital inputs: **CNT EN** (Count Enable) and **RES** (Reset) for free of voltage contacts and devices with NPN transistor outputs (Order Code **b = C**) or voltage inputs (the same voltage supply value)(Order Code **b = V**);

Outputs: Up to 2 outputs:
Relay: SPDT (8 A-AC1, 3 A-AC3/250 VAC) or
Voltage output to drive SSR (12VDC/15 mA);

Electrical life for relay outputs: 100000 operations;

Battery for counting without supply: Optional, 3.6 V internal rechargeable battery;

Consumption with battery supply: 4.5 mA approx.;

Voltage inputs absorption: 1 mA max.;

Installation category: II;

Protection class against electric shock: Class II for Front panel;

Insulation: Reinforced insulation between the low voltage section (supply and relay outputs) and the front panel; Reinforced insulation between the low voltage section (supply and relay outputs) and the extra low voltage section (inputs, SSR outputs); Reinforced insulation between the extra low voltage section (SSR outputs) and voltage inputs.

8.2 Mechanical data

Housing: Self-extinguishing plastic, UL 94 V0;

Dimensions: 48 x 48 mm DIN, depth 98 mm;

Weight: 200 g approx.;

Mounting: Flush in panel in 45 x 45 mm hole;

Connections: 2 x 1 mm² screw terminals block;

Protection degree: IP65 mounted in panel with gasket and screw type bracket;

Pollution degree: 2;

Operating temperature: 0... 50°C;

Operating humidity: 30... 95 RH% with no condensation;

Storage temperature: -10... +60°C.

8.3 Functional data

Outputs operating mode:

5 modes for OUT1:

- Delayed,
- Feedthrough,
- Asymmetric times oscillator with start in ON,
- Asymmetric times oscillator with start in OFF,
- One cycle Asymmetrical Oscillator Start OFF;

4 modes for OUT2:

- Like OUT1,
- ON during counting,
- Like OUT1 with time t_3 absolute
- Like OUT1 with time t_3 relative in advance;

Measurement range: 4 time scales:

- 9999 hours (9999),
- 99 hours and 59 minutes (9959),
- 59 minutes and 59 seconds (9959),
- 99 seconds 99 s/100 (hundreds of second)(9999);

Display resolution: According to the scale used: h, min, s, s/100;

Overall accuracy: $\pm 0.1\%$ fs;

Counting autonomy in case of power failure: About 10 hours when the battery is fully charged;

Inputs delay: 15 ms max.;

Display: 4 Digit Red h 12 mm;

Class and Structure of the Software: Class A;

Compliance: EMC Directive 2014/30/UE (EN 61326-1:2013), BT Directive 2014/35/UE (EN 61010-1:2010).

9. INSTRUMENT ORDER CODE

MODEL

TT49 - Timer with mechanical keys

a: POWER SUPPLY

F = 12 VAC/VDC

L = 24 VAC/VDC

H = 100...240 VAC

b: INPUTS

C = Free of voltage contacts/NPN transistor

V = Voltage inputs (the same of the Power Supply)

c: OUT1 OUTPUT

R = Relay output SPDT 8 A-AC1 (for resistive loads)

O = Voltage output to drive SSR (12VDC/15 mA)

d: OUT2 OUTPUT

R = Relay output SPDT 8 A-AC1 (for resistive loads)

O = Voltage output to drive SSR (12VDC/15 mA)

- = Not present

e: INTERNAL BATTERY

- = Battery not present

B = Battery present

ee: SPECIAL CODES

-- = Standard (AT package + "Butterfly"
type brackets)

-V = AT package + Screw type bracket for IP65

TT49 - a b c d e ff