

FILTERMIST **FX SERIES** OIL MIST FILTER

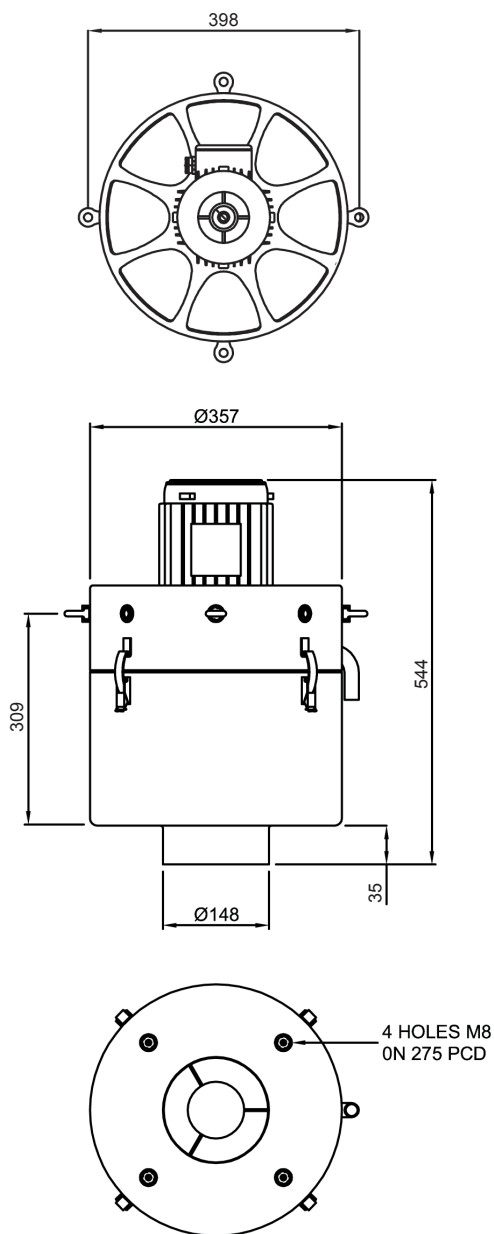

FX4002		
AIRFLOW (M ³ /HR)	1250 @ 50Hz 1500 @ 60Hz	
MOTOR ¹ (1.1 kW,3ph)	50Hz	60Hz
	200v, 220v, 380v, 400v, 415v	200v, 220v, 230v, 440v, 460v, 480v
WEIGHT (KG)	25.8	
NOISE ² (dBA)	70	
CONSTRUCTION	Mild Steel Powder Coated Grey RAL7035	

¹ Motors to be used on specified voltages only

² Results are in test conditions +/- 3% tolerance. Local variations and in use conditions may effect readings.

January 2014