





VALVE BODY W9 TYPE T

ART. NO. 850001

GENERAL

-  The KEOFITT CLASSIC W9 Sampling Valve is considered the father of all steam-sterilizable sampling valves. Refined through 40 years of experience it remains KEOFITT's most popular sampling valve designed to cover most needs for liquid sampling
-  The product to be sampled should have a maximum viscosity of 0-1.000 cP and should not contain particles larger than 2 mm diameter
-  The valve can be cleaned by means of SIP and/or CIP through the open valve seat
-  The sampling valve can be used at any process for taking out any samples for microbiological, chemical and/or physical analysis

FEATURES

-  Installation: Tank welding
-  Operation: Depending on choice of valve head
-  Inlet / Outlet: Hose piece
-  Membrane: Depending on choice of valve head

CERTIFICATION

· EHEDG CIP · Conform to 3-A · 3.1 Material Certificate · EU 1935/2004 · RA certificate

TECHNICAL DATA

Material (product contact)

· Steel parts ASI 316L (1.4404)

Material (without product contact)

· Steel parts ASI 316L (1.4404)
· Rubber cap EPDM
· Stainless steel chain Stainless steel

Surface Treatment

· Outer Surface Electropolished
· Inner Surface $\leq Ra 0.5 \mu m$

Pressure & Temperature

· Pressure Depending on choice of valve head
· Temperature Depending on choice of valve head

Net Weight







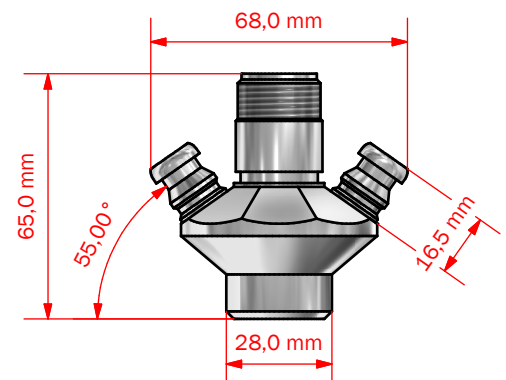
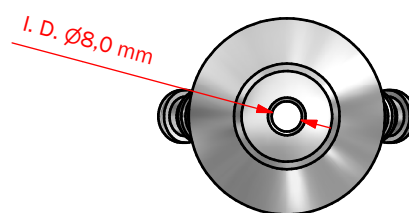
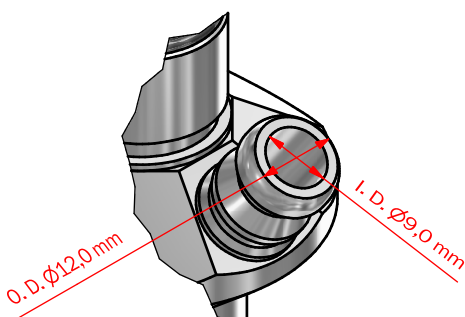
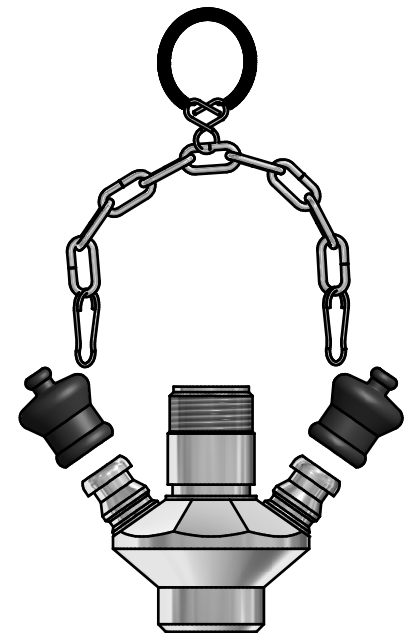

















· Kg/lbs 0,311 kg / 0,69 lbs

Spareparts

778501 SPARE PARTS FOR W9 850001/03/11/14/21/36



W 9 HEADS

	Type H Turn knob	Type H Turn knob with Microport option	Type K Key ring	Type K Key ring with Microport option	Key Ring for valve head	Type Q Lever handle	Type N Lever handle Pneumatic	Type B No spring 0-12 bar(g)
Silicone	 600041	 600048	 600042	 600049	 600076	 600043	 600044	 600047
EPDM	 600041E	 600048E	 600042E	 600049E	 600076	 600043E	 600044E	 600047E
PTFE	 855541	 Not available	 855542	 Not available	 600076	 855543	 855544	 855547