

# DMP 331

## Industrial Pressure Transmitter for Low Pressure

Stainless Steel Sensor

accuracy according to IEC 60770:  
standard: 0.35 % FSO  
option: 0.25 / 0.1 % FSO



### Nominal pressure

from 0 ... 100 mbar up to 0 ... 60 bar

### Output signals

2-wire: 4 ... 20 mA

3-wire: 0 ... 20 mA / 0 ... 10 V

others on request

### Special characteristic

- ▶ perfect thermal behaviour
- ▶ excellent long term stability
- ▶ pressure port  
G 1/2" flush from 100 mbar



### Optional versions

- ▶ IS-version  
Ex ia = intrinsically safe  
for gases and dusts
- ▶ SIL 2-according to  
IEC 61508 / IEC 61511
- ▶ welded pressure sensor
- ▶ customer specific versions

The pressure transmitter DMP 331 can be used in all industrial areas when the medium is compatible with stainless steel 1.4404 (316 L) or 1.4435 (316 L). Additional are different elastomer seals as well as a helium tested welded version available.

The modulare concept of the device allows to combine different stainless steel sensors and electronic modules with a variety of electrical and mechanical versions. Thus a diversity of variations is created, meeting almost all requirements in industrial applications.

### Preferred areas of use are

-  Plant and machine engineering
-  Environmental engineering  
(water - sewage - recycling)
-  Energy industry



Input pressure range										
Nominal pressure gauge	[bar]	-1...0	0.10	0.16	0.25	0.40	0.60	1	1.6	
Nominal pressure abs.	[bar]	-	-	-	-	0.40	0.60	1	1.6	
Overpressure	[bar]	5	0.5	1	1	2	5	5	10	
Burst pressure ≥	[bar]	7.5	1.5	1.5	1.5	3	7.5	7.5	15	
Nominal pressure gauge / abs.	[bar]	2.5	4	6	10	16	25	40	60	
Overpressure	[bar]	10	20	40	40	80	80	105	105	
Burst pressure ≥	[bar]	15	25	50	50	120	120	210	210	
Vacuum resistance		p <sub>N</sub> ≥ 1 bar: unlimited vacuum resistance p <sub>N</sub> < 1 bar: on request								
Output signal / Supply										
Standard		2-wire: 4 ... 20 mA / V <sub>S</sub> = 8 ... 32 V <sub>DC</sub>					SIL-version: V <sub>S</sub> = 14 ... 28 V <sub>DC</sub>			
Option IS-protection		2-wire: 4 ... 20 mA / V <sub>S</sub> = 10 ... 28 V <sub>DC</sub>					SIL-version: V <sub>S</sub> = 14 ... 28 V <sub>DC</sub>			
Options 3-wire		3-wire: 0 ... 20 mA / V <sub>S</sub> = 14 ... 30 V <sub>DC</sub> 0 ... 10 V / V <sub>S</sub> = 14 ... 30 V <sub>DC</sub>								
Performance										
Accuracy <sup>1</sup>		standard: nominal pressure < 0.4 bar: ≤ ± 0.50 % FSO nominal pressure ≥ 0.4 bar: ≤ ± 0.35 % FSO option 1: nominal pressure ≥ 0.4 bar: ≤ ± 0.25 % FSO option 2: for all nominal pressure ranges: ≤ ± 0.10 % FSO								
Permissible load		current 2-wire: R <sub>max</sub> = [(V <sub>S</sub> - V <sub>S min</sub> ) / 0.02 A] Ω current 3-wire: R <sub>max</sub> = 240 Ω voltage 3-wire: R <sub>min</sub> = 10 kΩ								
Influence effects		supply: 0.05 % FSO / 10 V					load: 0.05 % FSO / kΩ			
Long term stability		≤ ± 0.1 % FSO / year at reference conditions								
Response time		2-wire: ≤ 10 msec					3-wire: ≤ 3 msec			
<sup>1</sup> accuracy according to IEC 60770 – limit point adjustment (non-linearity, hysteresis, repeatability)										
Thermal effects (offset and span)										
Nominal pressure p <sub>N</sub>	[bar]	-1 ... 0			< 0.40			≥ 0.40		
Tolerance band	[% FSO]	≤ ± 0.75			≤ ± 1			≤ ± 0.75		
in compensated range	[°C]	-20 ... 85			0 ... 70			-20 ... 85		
Permissible temperatures										
Permissible temperatures		medium: -40 ... 125 °C electronics / environment: -40 ... 85 °C storage: -40 ... 100 °C								
Electrical protection										
Short-circuit protection		permanent								
Reverse polarity protection		no damage, but also no function								
Electromagnetic compatibility		emission and immunity according to EN 61326								
Mechanical stability										
Vibration		10 g RMS (25 ... 2000 Hz) according to DIN EN 60068-2-6								
Shock		500 g / 1 msec according to DIN EN 60068-2-27								
Materials										
Pressure port		stainless steel 1.4404 (316 L)								
Housing		stainless steel 1.4404 (316 L)								
Option compact field housing		stainless steel 1.4301 (304); cable gland M12x1.5, brass, nickel plated (clamping range 2 ... 8 mm)								
Seals		standard: FKM options: EPDM welded version <sup>2</sup> (for p <sub>N</sub> ≤ 40 bar) others on request								
Diaphragm		stainless steel 1.4435 (316 L)								
Media wetted parts		pressure port, seals, diaphragm								
<sup>2</sup> welded version only with pressure ports according to EN 837, p <sub>N</sub> ≤ 40 bar										
Explosion protection (only for 4 ... 20 mA / 2-wire)										
Approvals DX19-DMP 331		IBExU 10 ATEX 1068 X / IECEx IBE 12.0027X zone 0: II 1G Ex ia IIC T4 Ga zone 20: II 1D Ex ia IIIC T135 °C Da								
Safety technical maximum values		U <sub>i</sub> = 28 V, I <sub>i</sub> = 93 mA, P <sub>i</sub> = 660 mW, C <sub>i</sub> ≈ 0 nF, L <sub>i</sub> ≈ 0 μH, the supply connections have an inner capacity of max. 27 nF to the housing								
Permissible temperatures for environment		in zone 0: -20 ... 60 °C with p <sub>atm</sub> 0.8 bar up to 1.1 bar in zone 1 or higher: -40/-20 ... 70 °C								
Connecting cables (by factory)		cable capacitance: signal line/shield also signal line/signal line: 160 pF/m cable inductance: signal line/shield also signal line/signal line: 1 μH/m								

# DMP 331

Industrial Pressure Transmitter

Technical Data

Miscellaneous	
Option SIL2 version <sup>3</sup>	according to IEC 61508 / IEC 61511
Current consumption	signal output current: max. 25 mA signal output voltage: max. 7 mA
Weight	approx. 200 g
Installation position	any <sup>4</sup>
Operational life	100 million load cycles
CE-conformity	EMC Directive: 2014/30/EU
ATEX Directive	2014/34/EU

<sup>3</sup> only for 4 ... 20 mA / 2-wire, not in combination with accuracy 0.1 %

<sup>4</sup> Pressure transmitters are calibrated in a vertical position with the pressure connection down. If this position is changed on installation there can be slight deviations in the zero point for pressure ranges  $p_N \leq 1$  bar.

## Wiring diagrams

2-wire-system (current)

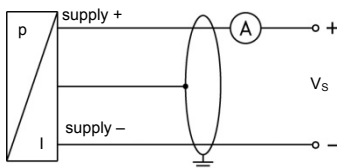

3-wire-system (current / voltage)

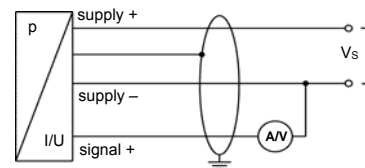

## Pin configuration

Electrical connection	ISO 4400	Binder 723 (5-pin)	M12x1/ metal (4-pin)	Bayonet MIL-C-26482 (10-6)		compact field housing	cable colours (IEC 60757)
				2-wire	3-wire		
Supply +	1	3	1	A	A	IN +	WH (white)
Supply -	2	4	2	B	D	IN -	BN (brown)
Signal + (for 3-wire)	3	1	3	-	B	OUT +	GN (green)
Shield	ground pin	5	4	pressure port			GNYE (green-yellow)

## Electrical connections (dimensions in mm)

standard

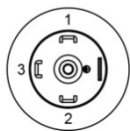
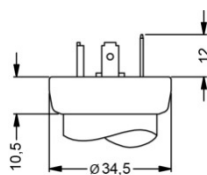

ISO 4400 (IP 65)

options

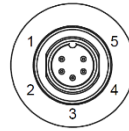
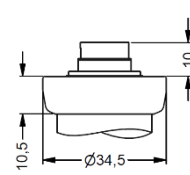

Binder series 723, 5-pin (IP 67)

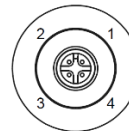
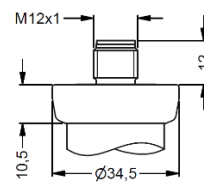

M12x1, 4-pin (IP 67)

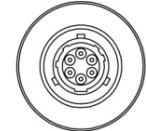
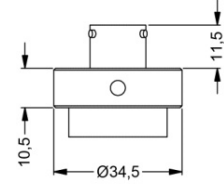

Bayonet MIL-C-26482 (10-6) (IP 67)

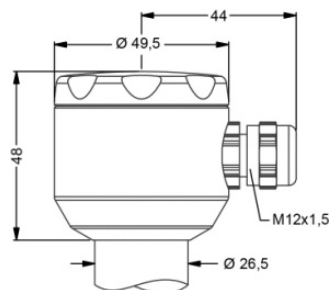

compact field housing (IP 67)

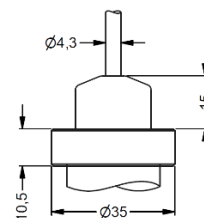

cable outlet with PVC cable (IP 67)<sup>5</sup>

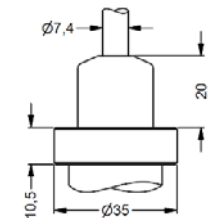

cable outlet, cable with ventilation tube (IP 68)<sup>6</sup>

⇒ universal field housing stainless steel 1.4404 (316 L) with cable gland M20x1.5 (ordering code 880) and other versions on request

<sup>5</sup> standard: 2 m PVC cable without ventilation tube (permissible temperature: -5 ... 70 °C)

<sup>6</sup> different cable types and lengths available, permissible temperature depends on kind of cable

**Mechanical connections (dimensions in mm)**

**standard**

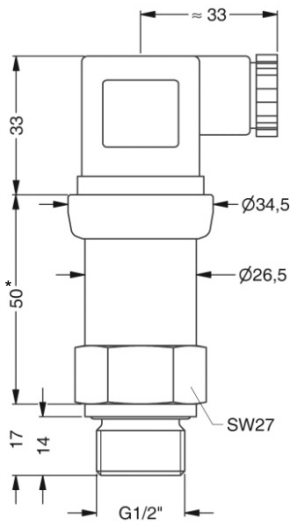

G1/2" DIN 3852  
with ISO 4400

**SIL- and SIL-IS-version**

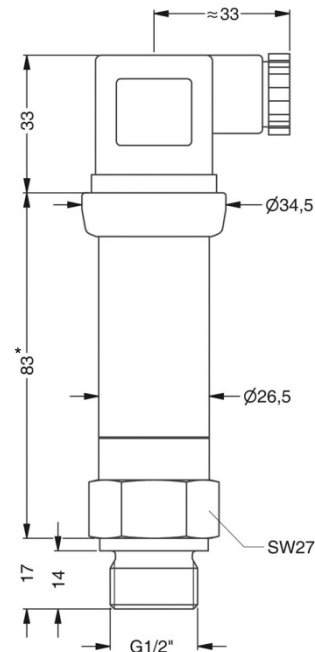

G1/2" DIN 3852  
with ISO 4400

**options**

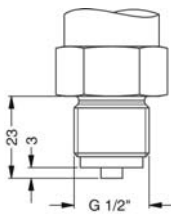

G1/2" EN 837

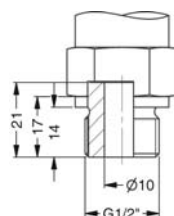

G1/2" DIN 3852 open port,  $p_N \leq 40$  bar

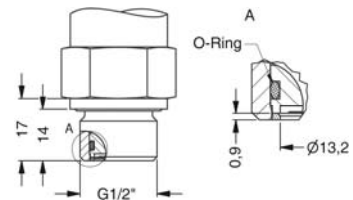

G1/2" DIN 3852  
with flush sensor,  $p_N \leq 40$  bar

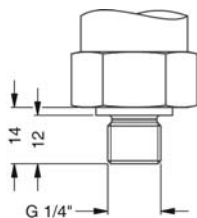

G1/4" DIN 3852

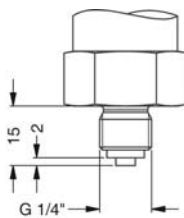

G1/4" EN 837

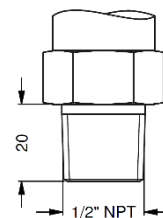

1/2" NPT

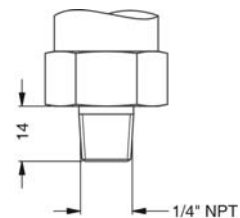

1/4" NPT

⇒ metric threads and other versions on request

\* with electrical connection Bayonet MIL-C-26482 (10-6) increases the length of devices by 5 mm

© 2020 BDSENSORS GmbH – The specifications given in this document represent the state of engineering at the time of publishing. We reserve the right to make modifications to the specifications and materials.

## Ordering code DMP 331

DMP 331

--	--	--	--	--	--	--	--	--	--	--	--	--	--	--	--	--	--	--	--

Pressure																						
gauge		1	1	0																		
absolute <sup>1</sup>		1	1	1																		
Input																						
[bar]																						
0.10 <sup>1</sup>		1	0	0	0																	
0.16 <sup>1</sup>		1	6	0	0																	
0.25 <sup>1</sup>		2	5	0	0																	
0.40		4	0	0	0																	
0.60		6	0	0	0																	
1.0		1	0	0	1																	
1.6		1	6	0	1																	
2.5		2	5	0	1																	
4.0		4	0	0	1																	
6.0		6	0	0	1																	
10		1	0	0	2																	
16		1	6	0	2																	
25		2	5	0	2																	
40		4	0	0	2																	
60		6	0	0	2																	
-1 ... 0		X	1	0	2																	
customer		9	9	9	9																	
Output																						
4 ... 20 mA / 2-wire																				1		
0 ... 20 mA / 3-wire																				2		
0 ... 10 V / 3-wire																				3		
intrinsic safety 4 ... 20 mA / 2-wire																				E		
SIL2 4 ... 20 mA / 2-wire																				1S		
SIL2 with intrinsic safety 4 ... 20 mA / 2-wire																				ES		
customer																				9		
Accuracy																						
standard for p <sub>N</sub> ≥ 0.4 bar:	0.35 % FSO																			3		
standard for p <sub>N</sub> < 0.4 bar:	0.50 % FSO																			5		
option 1 for p <sub>N</sub> ≥ 0.4 bar:	0.25 % FSO																			2		
option 2:	0.10 % FSO <sup>2</sup>																			1		
customer																				9		
Electrical connection																						
male and female plug ISO 4400																				1	0	0
male plug Binder series 723 (5-pin)																				2	0	0
cable outlet with PVC cable (IP67) <sup>3</sup>																				T	A	0
cable outlet,																				T	R	0
cable with ventilation tube (IP68) <sup>4</sup>																				M	1	0
male plug M12x1 (4-pin) / metal																				B	G	0
Bayonet MIL-C-26482 (10-6); 2 wire																				B	G	4
Bayonet MIL-C-26482 (10-6); 3 wire																				8	5	0
compact field housing																				9	9	9
stainless steel 1.4301 (304)																				9	9	9
customer																				9	9	9
Mechanical connection																						
G1/2" DIN 3852																				1	0	0
G1/2" EN 837																				2	0	0
G1/4" DIN 3852																				3	0	0
G1/4" EN 837																				4	0	0
G1/2" DIN 3852																				F	0	0
with flush sensor <sup>5</sup>																				H	0	0
G1/2" DIN 3852 open pressure port <sup>5</sup>																				N	0	0
1/2" NPT																				N	4	0
1/4" NPT																				9	9	9
customer																				9	9	9
Seals																						
FKM																				1		
EPDM																				3		
without (welded version) <sup>5,6</sup>																				2		
customer																				9		
Special version																						
standard																				0	0	0
customer																				9	9	9

<sup>1</sup> absolute pressure possible from 0.4 bar  
<sup>2</sup> not in combination with SIL  
<sup>3</sup> standard: 2 m PVC cable without ventilation tube (permissible temperature: -5 ... 70°C), others on request  
<sup>4</sup> code TR0 = PVC cable, cable with ventilation tube available in different types and lengths  
<sup>5</sup> only for p<sub>N</sub> ≤ 40 bar  
<sup>6</sup> welded version only with pressure ports according to EN 837

© 2020 BDSENSORS GmbH - The specifications given in this document represent the state of engineering at the time of publishing. We reserve the right to make modifications to the specifications and materials.