

ENG

User Guide

3200i

Process Indicator



Invensys

EUROTHERM

3200i Series Process Indicators and Alarm Units

Applies to Model numbers 3216i, 32h8i and 3204i

Contents

1.	What Instrument Do I Have?	4
1.1	Unpacking Your Indicator	5
1.2	Dimensions Front Views	5
1.3	Dimensions – Side and Top Views	6
1.4	Step 1: Installation	7
1.4.1	Panel Mounting the Indicator	7
1.4.2	Panel Cut-out Sizes	7
1.4.3	Recommended minimum spacing of indicators.	8
1.4.4	To Remove the Indicator from its Sleeve	8
1.5	Ordering Code	9
2.	Step 2: Wiring	10
2.1	Terminal Layout 3216i Indicator	10
2.2	Terminal Layout 32h8i Indicator	11
2.3	Terminal Layout 3204i Indicators	12
2.4	Wire Sizes	13
2.5	Sensor Input (Measuring Input)	13
2.6	Outputs - 1/8 and 1/4 DIN Indicators	14
2.6.1	Output 1 & Output 4 (AA Relay)	14
2.6.2	Output 3 Retransmission	15

2.6.3	Transmitter Supply.....	15
2.6.4	Digital Inputs A and B.....	15
2.6.5	Transducer Supply.....	15
2.7	Indicator Power Supply	16
2.8	Example Wiring Diagram	16
2.9	Digital Communications (Optional)	17
2.10	Additional Connections for 3216i.....	18
2.10.1	Input/Output 1 & Output 2.....	18
3.	Safety and EMC Information.....	19
3.1	Installation Safety Requirements.....	20
4.	Switch On.....	24
4.1	New Indicator.....	24
4.1.1	To Re-Enter Quick Code Mode.....	28
4.2	Pre-Configured Controller or Subsequent Starts.....	28
4.3	Front panel layout.....	29
4.3.1	Alarm Indication.....	30
4.3.2	Out of Range Indication.....	30
4.3.3	Sensor Break Indication.....	30
4.4	Operator Parameters in Level 1	31
4.4.1	Tare Correction.....	32
5.	Operator Level 2.....	33
5.1	To Enter Level 2	33
5.1.1	To Return to Level 1.....	33
5.2	Level 2 Parameters	34

5.3	Strain Gauge Calibration.....	38
5.3.1	Load Cell Calibration.....	38
5.3.2	Comparison Calibration.....	39
5.3.3	Shunt Calibration.....	39
5.3.4	Manual Calibration.....	40
5.3.5	Automatic Calibration.....	40
5.3.6	Calibration Using a Digital Input.....	41
5.4	Recipes	42
5.4.1	To Store Values in a Recipe	42
5.4.2	To Load a Recipe	42

Installation and Basic Operation

1. What Instrument Do I Have?

Thank you for choosing this 3200i series Process Indicator.

These are available as:-

Model	Size	Inputs	Outputs
3216i	1/16 DIN	Thermocouple Pt100 RTD V/mA/mV	1 – Relay, Logic, Analogue or dig in 2 – Relay, or Analogue 4 Changeover relay
32h8i	1/8 DIN	Thermocouple Pt100 RTD V/mA/mV 2 Digital	1 Changeover relay 3 Retransmission 4. Changeover relay and Transmitter PSU
32h8i/SG	1/8 DIN	Strain gauge	As 32h8i
3204i	1/4 DIN	As 3216i	As 32h8i

Relay outputs can be configured for alarm and events and analogue retransmission of process variable. 2-wire Modbus digital communications is available in all models.

The indicator may have been ordered to a hardware code only or pre-configured using an optional 'Quick Start' code. The label fitted to the side of the sleeve shows the ordering code of the indicator. If the Quick Code shows ***** the indicator will need to be configured when it is first switched on.

This User Guide takes you through step by step instructions to help you to install, wire, configure and use the indicator. For features not covered in this User Guide, a detailed Engineering Manual, Part No HA029006, and other related handbooks can be downloaded from www.eurotherm.co.uk.

1.1 Unpacking Your Indicator

The following items are included in the box:

- Indicator mounted in its sleeve
- Two panel retaining clips
- AN IP65 sealing gasket mounted on the sleeve
- Component packet containing a snubber for each relay output and a 2.49Ω resistor for current inputs (see section 2)
- This User Guide

1.2 Dimensions Front Views

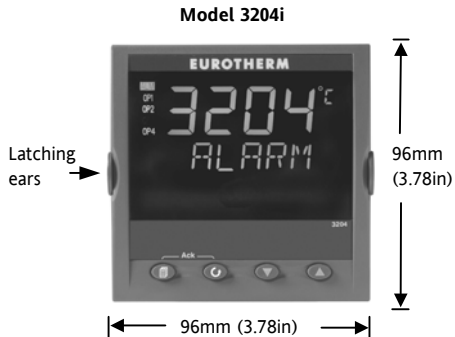
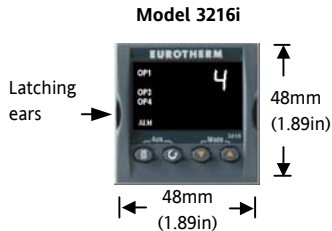

1.3 Dimensions – Side and Top Views

Side View – 1/8 DIN & 1/4 DIN

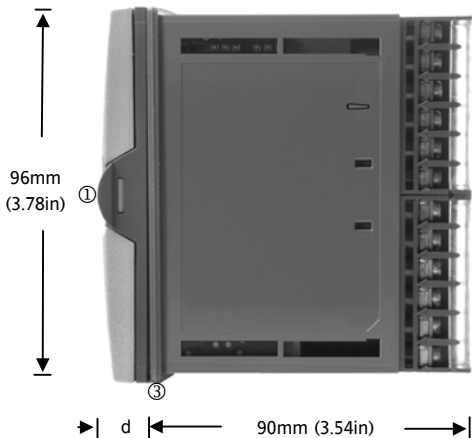

- ① Latching ears
- ② Panel retaining clip
- ③ IP65 Sealing Gasket

Side View – 1/16 DIN

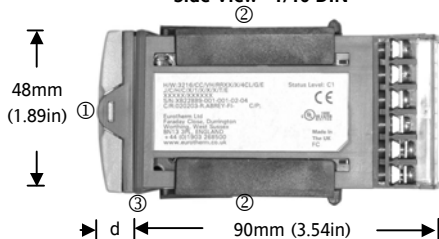

Top View – 1/16 & 1/8 DIN

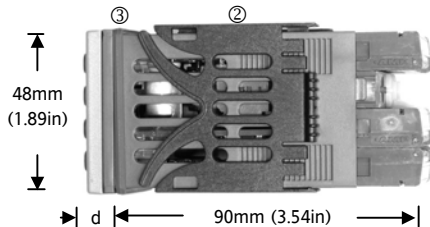

d = Fascia depth 1.25mm (0.5in)

1.4 Step 1: Installation

This indicator is intended for permanent installation, for indoor use only, and enclosed in an electrical panel

Select a location which is subject to minimum vibrations, the ambient temperature is within 0 and 55°C (32 - 131°F) and humidity 5 to 95% RH non condensing.

The indicator can be mounted on a panel up to 15mm thick

To ensure IP65 and NEMA 4 front sealing against dust and water, mount on a non-textured surface.

Please read the safety information in section 3 before proceeding. The EMC Booklet part number HA025464 gives further installation information.

1.4.1 Panel Mounting the Indicator

1. Prepare a cut-out in the mounting panel to the size shown. If a number of instruments are to be mounted in the same panel observe the minimum spacing shown.
2. Fit the IP65 sealing gasket behind the front bezel of the indicator

3. Insert the indicator through the cut-out
4. Spring the panel retaining clips into place. Secure the indicator in position by holding it level and pushing both retaining clips forward.
5. Peel off the protective cover from the display

1.4.2 Panel Cut-out Sizes

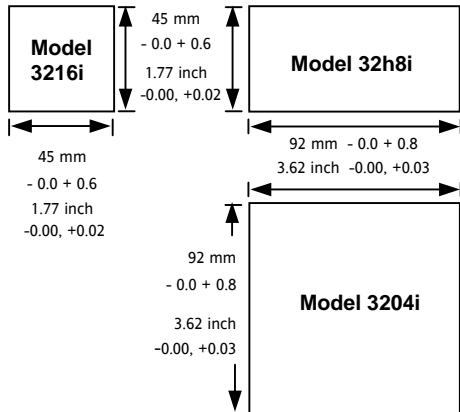

1.4.3 Recommended minimum spacing of indicators.

Applies to all Model sizes

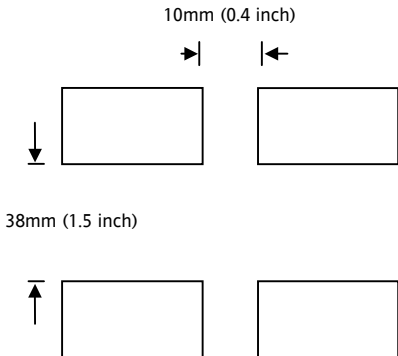

(Not to scale)

1.4.4 To Remove the Indicator from its Sleeve





The indicator can be unplugged from its sleeve by easing the latching ears outwards and pulling it forward out of the sleeve. When plugging it back into its sleeve, ensure that the latching ears click back into place to maintain the IP65 sealing.

1.5 Ordering Code

1	2	3	4	5	6	7	8	9	10	11	12	13	14	Quick Start Code (see section 4)								
1. Model No.								5. AA Relay (OP4)						10. Input Adaptor								
3216i		1/16 DIN size						R		Relay (Form C)				XX	None							
32h8i		1/8 DIN size (horizontal)						6. Options						V1	1-10Vdc							
3204i		1/4 DIN size												XXX	Not fitted (3216i only)					A1	mA Burden Resistor (2.49Ω)	
2. Function								7. Fascia colour/type						11. Warranty								
AL		Standard Unit												XXL		Digital input A (not 32h8i/SG, optional in 3216i)				Standard	XXXXXX	
FM		FM Alarm Unit												2XL		RS232 & Digital input A (includes Dig In A except 32h8i/SG)				Extended	WL005	
DN		DIN 3440 alarm unit						4XL		RS485 & Digital input A (includes Dig In A except 32h8i/SG)				12. Certificates								
SG		Strain Gauge Input 32h8i only						8/9 Product/Manual Language						None	XXXXXX							
3. Power Supply														CERT1		Cert of conformity				CERT2		5 Point Factory calibration
VL		24Vac/dc												G		Green				13. Custom Label		
VH		100–240Vac						S		Silver				XXXXXX	None							
4. Outputs (OP1, OP2, OP3)								14. Special and Accessories						XXXXXX		None						
LRXX		OP1 Logic, OP2 Relay *												ENG		English				RES250	250Ω ; 0-5Vdc OP	
RRXX		OP1 Relay, OP2 Relay *												FRA		French				RES500	500Ω ; 0-10Vdc OP	
LDXX		OP1 Logic, OP2 Analogue *												GER		German						
DRXX		OP1 Analogue, OP2 Relay *												ITA		Italian						
RXXX		OP1 Relay (32h8i & 3204i only)						SPA		Spanish												
RXDX		OP1 Relay, OP3 Analogue (32h8i & 3204i only)																				
* 3216i only																						

2. Step 2: Wiring

Key to Symbols used in the wiring diagrams

	Logic (SSR drive) output		Relay output		Contact input		mA analogue output
--	--------------------------	---	--------------	---	---------------	---	--------------------

2.1 Terminal Layout 3216i Indicator



Ensure that you have the correct supply for your indicator. Check order code of the indicator supplied

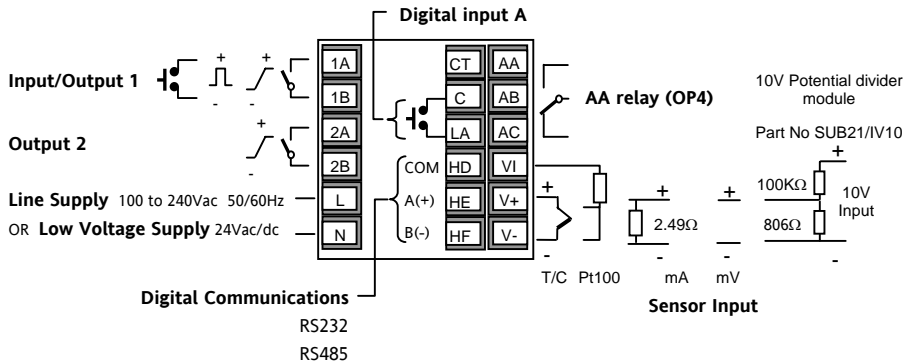

2.2 Terminal Layout 32h8i Indicator



Ensure that you have the correct supply for your indicator. Check order code of the indicator supplied

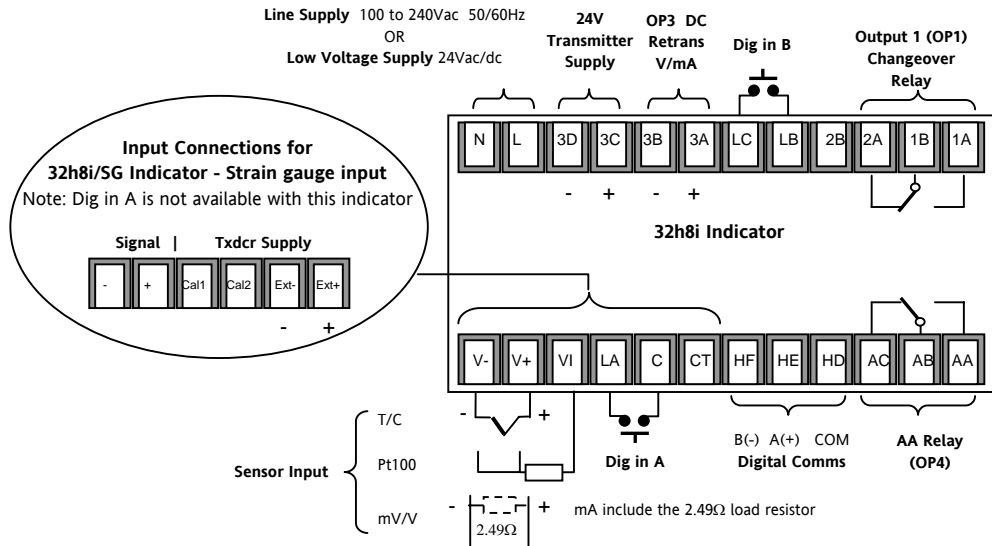

2.3 Terminal Layout 3204i Indicators



Ensure that you have the correct supply for your indicator. Check order code of the indicator supplied

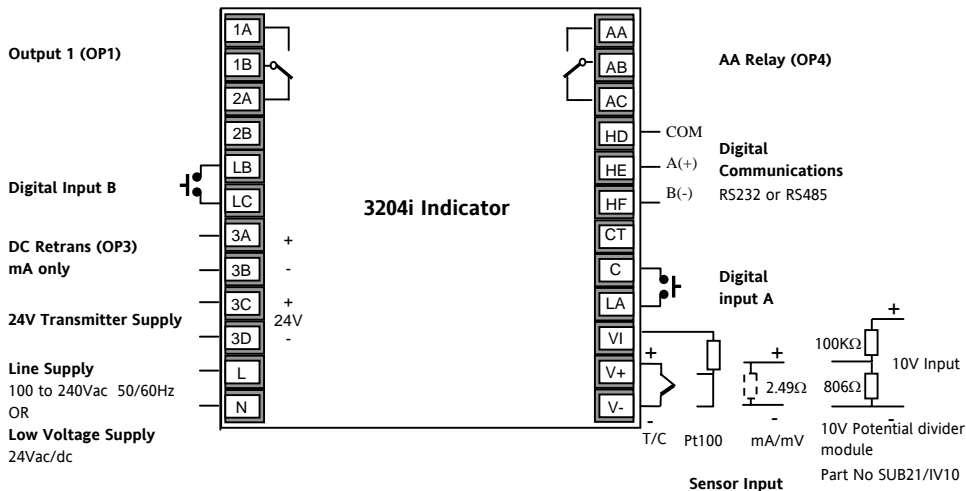

2.4 Wire Sizes

The screw terminals accept wire sizes from 0.5 to 1.5 mm (16 to 22AWG). Hinged covers prevent hands or metal making accidental contact with live wires. The rear terminal screws should be tightened to 0.4Nm (3.5lb in).

2.5 Sensor Input (Measuring Input)

- Do not run input wires with power cables
- When shielded cable is used, it should be grounded at one point only
- Any external components (such as zener barriers) connected between sensor and input terminals may cause errors in measurement due to excessive and/or un-balanced line resistance, or leakage currents.
- Not isolated from the logic outputs & digital inputs

Thermocouple Input



Positive

Negative

- Use the correct compensating cable preferably shielded.

RTD Input

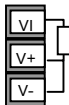

PRT

PRT

Lead compensation

- The resistance of the three wires must be the same. The line resistance may cause errors if it exceeds 22Ω.

Linear mA, or mV Inputs

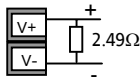

Positive

Negative

- For a mA input connect the 2.49Ω burden resistor supplied between the V+ and V- terminals as shown. For mV omit this resistor.

Linear Voltage Inputs

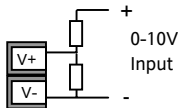

- An external potential divider is required for 3216i and 3204i available as part no SUB21/IV10.

2.6 Outputs - 1/8 and 1/4 DIN Indicators

32h8i and 3204i indicators are supplied as standard with two changeover relay outputs.

2.6.1 Output 1 & Output 4 (AA Relay)

Relay (Form C, changeover)

OP1

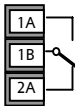

OP4

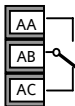

- Isolated output 240Vac CATII
- Contact rating:: 2A 264Vac resistive
- Output functions: Alarm/Event

* General Notes about Relays and Inductive Loads

High voltage transients may occur when switching inductive loads such as some contactors or solenoid valves. Through the internal contacts, these transients may introduce disturbances which could affect the performance of the instrument.

For this type of load it is recommended that a 'snubber' is connected across the normally open contact of the relay switching the load. The snubber recommended consists of a series connected resistor/capacitor (typically 15nF/100Ω). A snubber will also prolong the life of the relay contacts.

A snubber should also be connected across the output terminal of a triac output to prevent false triggering under line transient conditions.

WARNING

When the relay contact is open, or it is connected to a high impedance load, it passes a current (typically 0.6mA at 110Vac and 1.2mA at 240Vac). You must ensure that this current will not hold on low power electrical loads. If the load is of this type the snubber should not be connected.

2.6.2 Output 3 Retransmission (Output 2 3216i)

OP3

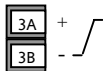

- Isolated output 240Vac CATII
- Software configurable: 0-20mA or 4-20mA plus 0-5V, 0-10V, 1-5V and 2-10V.
- Max load resistance: 500Ω
- Calibration accuracy: \pm ($<0.25\%$ of reading + $<50\mu\text{A}$)
- Output functions: PV retransmission.
- Output 2 non-isolated on 3216i

2.6.3 Transmitter Supply

A fixed 24Vdc supply is available to power an external transducer (not 32i6i).



- Isolated output 240Vac CATII

2.6.4 Digital Inputs A and B

Digital input A is not available in 32h8i/SG and optionally available on 3216i.

Dig In A



Dig In B



- Not isolated from the sensor input
- Switching: 12Vdc at 40mA max
- Contact open $> 500\Omega$. Contact closed $< 200\Omega$
- Input functions: Please refer to the list in the quick codes.

2.6.5 Transducer Supply

In 32h8i/SG a 10Vdc supply is available as an excitation voltage for a bridge type transducer



- Minimum load resistance 300Ω
- Isolated output 240Vac CATII

2.7 Indicator Power Supply

1. Before connecting the indicator to the power line, make sure that the line voltage corresponds to the description on the identification label.
2. Use copper conductors only.
3. The power supply input is not fuse protected. This should be provided externally.
4. For 24V the polarity is not important.

Power Supply



- High voltage supply: 100 to 240Vac, -15%, +10%, 50/60 Hz
- Low voltage supply: 24Vac/dc, -15%, +10%
- Recommended external fuse ratings are as follows:-
 - For 24 V ac/dc, fuse type: T rated 2A 250V
 - For 100-240Vac, fuse type: T rated 2A 250V.

2.8 Example Wiring Diagram

This shows 32h8i connected to a strain gauge bridge.

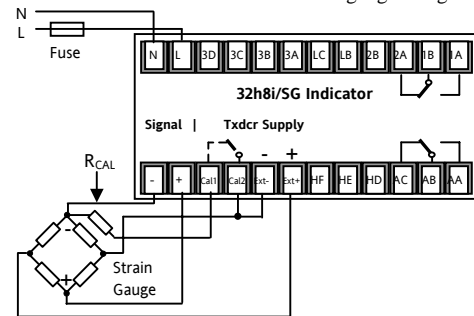

Safety requirements for permanently connected equipment state:

- A switch or circuit breaker shall be included in the building installation
- It shall be in close proximity to the equipment and within easy reach of the operator
- It shall be marked as the disconnecting device for the equipment.

Note: a single switch or circuit breaker can drive more than one instrument.

2.9 Digital Communications (Optional)

Digital communications uses the Modbus protocol. The interface may be ordered as RS232 or RS485 (2-wire).

- Isolated 240Vac CATII.

RS232 Connections

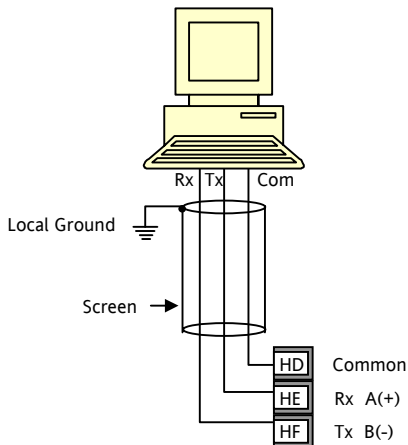

RS485 Connections

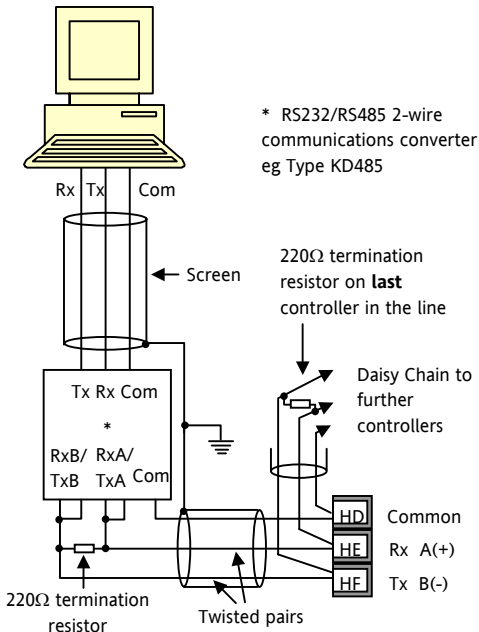

* RS232/RS485 2-wire communications converter eg Type KD485

2.10 Additional Connections for 3216i

Connections for the 3216i indicator are similar to the 3216 controller.

2.10.1 Input/Output 1 & Output 2

I/O1 may be configured as input or output.

Outputs can be logic (SSR drive), or relay, or mA dc.

Input is contact closure.

Relay Output (Form A, normally open)

OP1/2



- Isolated output 240Vac CATII
- Contact rating: 2A 264Vac resistive
- Output functions: Alarm or event

Logic (SSR drive) Output

OP1

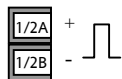

- Not isolated from the sensor input
- Output ON state: 12Vdc at 40mA max
- Output OFF state: <300mV, <100μA

- Output functions: Alarm or event

DC Output

OP1/2

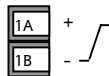

- Not isolated from the sensor input
- Software configurable: 0-20mA or 4-20mA.
- Max load resistance: 500Ω
- Calibration accuracy: 1%, ±100μA
- Output functions: Retransmission.

Logic Contact Closure Input (OP1 only)

- Not isolated from the sensor input

OP1



- Switching: 12Vdc at 40mA max
- Contact open > 500Ω. Contact closed < 150Ω
- Input functions: Please refer to the list in the Quick Start codes.

3. Safety and EMC Information

This indicator is intended for industrial temperature and process applications when it will meet the requirements of the European Directives on Safety and EMC. Use in other applications, or failure to observe the installation instructions of this handbook may impair safety or EMC. The installer must ensure the safety and EMC of any particular installation.

Safety

This indicator complies with the European Low Voltage Directive 73/23/EEC, by the application of the safety standard EN 61010.

Electromagnetic compatibility

This indicator conforms with the essential protection requirements of the EMC Directive 89/336/EEC, by the application of a Technical Construction File. This instrument satisfies the general requirements of the industrial environment defined in EN 61326. For more information on product compliance refer to the Technical Construction File.

GENERAL

The information contained in this manual is subject to change without notice. While every effort has been made to ensure the accuracy of the information, your supplier shall not be held liable for errors contained herein.

Unpacking and storage

The packaging should contain an instrument mounted in its sleeve, two mounting brackets for panel installation and an Installation & Operating guide. Certain ranges are supplied with an input adapter.

If on receipt, the packaging or the instrument is damaged, do not install the product but contact your supplier. If the instrument is to be stored before use, protect from humidity and dust in an ambient temperature range of -10°C to $+70^{\circ}\text{C}$.

Service and repair

This indicator has no user serviceable parts. Contact your supplier for repair.

Caution: Charged capacitors

Before removing an instrument from its sleeve, disconnect the supply and wait at least two minutes to allow capacitors to discharge. It may be convenient to partially withdraw the instrument from the sleeve, then pause before completing the removal. In any case, avoid touching the exposed electronics of an instrument when withdrawing it from the sleeve.

Failure to observe these precautions may cause damage to components of the instrument or some discomfort to the user.

Electrostatic discharge precautions

When the indicator is removed from its sleeve, some of the exposed electronic components are vulnerable to damage by electrostatic discharge from someone handling the indicator. To avoid this, before handling the unplugged controller discharge yourself to ground.

Cleaning

Do not use water or water based products to clean labels or they will become illegible. Isopropyl alcohol may be used to clean labels. A mild soap solution

may be used to clean other exterior surfaces of the product.

3.1 Installation Safety Requirements

Safety Symbols

Various symbols may be used on the indicator. They have the following meaning:



Caution, (refer to accompanying documents)



Equipment protected throughout by DOUBLE INSULATION



Helpful hints

Personnel

Installation must only be carried out by suitably qualified personnel

Enclosure of Live Parts

To prevent hands or metal tools touching parts that may be electrically live, the controller must be enclosed in an enclosure.

Caution: Live sensors

The indicator is designed to operate if the temperature sensor is connected directly to an electrical heating element. However, you must ensure that service personnel do not touch connections to these inputs while they are live. With a live sensor, all cables, connectors and switches for connecting the sensor must be mains rated for use in 240Vac CATII.

Wiring

It is important to connect the indicator in accordance with the wiring data given in this guide. Take particular care not to connect AC supplies to the low voltage sensor input or other low level inputs and outputs. Only use copper conductors for connections (except thermocouple inputs) and ensure that the wiring of installations comply with all local wiring regulations. For example in the UK use the latest version of the IEE wiring regulations, (BS7671). In the USA use NEC Class 1 wiring methods.

Power Isolation

The installation must include a power isolating switch or circuit breaker. This device should be in close proximity to the indicator, within easy reach of the

operator and marked as the disconnecting device for the instrument.

Overcurrent protection

The power supply to the system should be fused appropriately to protect the cabling to the units.

Voltage rating

The maximum continuous voltage applied between any of the following terminals must not exceed 240Vac:

- relay output to logic, dc or sensor connections;
- any connection to ground.

The indicator must not be wired to a three phase supply with an unearthed star connection. Under fault conditions such a supply could rise above 240Vac with respect to ground and the product would not be safe.

Conductive pollution

Electrically conductive pollution must be excluded from the cabinet in which the indicator is mounted. For example, carbon dust is a form of electrically conductive pollution. To secure a suitable atmosphere

in conditions of conductive pollution, fit an air filter to the air intake of the cabinet. Where condensation is likely, for example at low temperatures, include a thermostatically controlled heater in the cabinet.

This product has been designed to conform to BSEN61010 installation category II, pollution degree 2. These are defined as follows:-

Installation Category II (CAT II)

For equipment on nominal 230V supply, the maximum rated impulse voltage is 2500V.

Pollution Degree 2

Normally only non conductive pollution occurs. Occasionally, however, a temporary conductivity caused by condensation shall be expected.

Grounding of the temperature sensor shield

In some installations it is common practice to replace the temperature sensor while the controller is still powered up. Under these conditions, as additional protection against electric shock, we recommend that the shield of the temperature sensor is grounded. Do not rely on grounding through the framework of the machine.

Over-temperature protection

When designing any control system it is essential to consider what will happen if any part of the system should fail. In temperature control applications the primary danger is that the heating will remain constantly on. Apart from spoiling the product, this could damage any process machinery being controlled, or even cause a fire.

Reasons why the heating might remain constantly on include:

- the temperature sensor becoming detached from the process
- thermocouple wiring becoming short circuit;
- the controller failing with its heating output constantly on
- an external valve or contactor sticking in the heating condition
- the controller setpoint set too high.

Where damage or injury is possible, we recommend fitting a separate over-temperature protection unit,

with an independent temperature sensor, which will isolate the heating circuit.

This indicator can be used in addition to a controller as an over temperature device. It is recommended that the relay used to indicate the alarm condition should be set to high alarm configured with sensor break and inverse 'l n' operation so that it relaxes to the alarm condition when power is removed.

Installation requirements for EMC

To ensure compliance with the European EMC directive certain installation precautions are necessary as follows:

- For general guidance refer to Eurotherm Controls EMC Installation Guide, HA025464.
- When using relay outputs it may be necessary to fit a filter suitable for suppressing the emissions. The filter requirements will depend on the type of load. For typical applications we recommend Schaffner FN321 or FN612.
- If the unit is used in table top equipment which is plugged into a standard power socket, then it is likely that compliance to the commercial and light industrial emissions standard is required.

In this case to meet the conducted emissions requirement, a suitable mains filter should be installed. We recommend Schaffner types FN321 and FN612.

Routing of wires

To minimise the pick-up of electrical noise, the low voltage DC connections and the sensor input wiring should be routed away from high-current power cables. Where it is impractical to do this, use shielded cables with the shield grounded at both ends. In general keep cable lengths to a minimum.

4. Switch On

4.1 New Indicator

If the indicator is new and has not previously been configured it will start up showing the 'Quick Configuration' codes. This is a built in tool which enables you to configure the input type and range, the output functions and the display format.









Incorrect configuration can result in damage to the process and/or personal injury and must be carried out by a competent person authorised to do so. It is the responsibility of the person commissioning the instrument to ensure the configuration is correct



The quick code consists of two 'SETS' of five characters. The upper section of the display shows the set selected, the lower section shows the five digits which make up the set.

Adjust these as follows:-



1. Press any button. The first character will change to a flashing '-'.
 or 
2. Press  or  to change the flashing character to the required code shown in the quick code tables –see next page. Note: An $\bar{\text{H}}$ indicates that the option is not fitted.
3. Press  to scroll to the next character.

 You cannot scroll to the next character until the current character is configured.

 To return to the first character press .

When all five characters have been configured the display will go to Set 2.

When the last digit has been entered press  again,

the display will show

Press  or  to . The indicator will then automatically go to the operator level.

SET 1

K C H C O

Input Type	
G	Strain gauge
	32h8i only
Thermocouple	
B	Type B
J	Type J
K	Type K
L	Type L
N	Type N
R	Type R
S	Type S
T	Type T
C	Custom C
RTD	
P	Pt100
Linear (all units)	
M	0-80mV
2	0-20mA
4	4-20mA
Linear 32h8i only	
0	0-10Vdc
1	1-5Vdc
3	2-10Vdc
6	0-5Vdc

Display units			
Temperature			
C	°C		
F	°F		
K	K		
X	None		
P	%		
32h8i/SG only:			
0	Pa	D	L-m
1	mPa	E	%RH
2	Kpa	G	%O2
3	Bar	H	%CO2
4	mBar	J	%CP
5	PSI	L	V
6	Kg/cm ²	M	Amp
7	mmWG	R	mA
8	inWG	T	mV
9	mmHG	U	Ohm
A	Torr	W	ppm
B	L-H	Y	RPM
		Z	m-s

Decimal point	
0	nnnnn ⁽¹⁾
1	nnnn.n ⁽¹⁾
2	nnn.nn ⁽¹⁾
3	nn.nnn ⁽¹⁾
4	n.nnnn ⁽¹⁾

PV Colour ⁽²⁾	
32h8i only	
G	Green
R	Red
C	Colour change on Alarm. Green to red
X	Not applicable

Home display	
N	PV only
A	First Alarm SP only
1	PV + Alarm SP R/W
2	PV + Alarm SP R/O

Set 1 is followed with R N G . H I Then R N G . L O	Set this for the maximum display range required Set this for the minimum display range required
---	--

Set 2 follows these parameters	See next page
--------------------------------	---------------

- (1) Up to 2 decimal places on 3216i and 3204i
Up to 4 decimal places on 32h8i
- (2) Colour change on top part of display only

OP1	
X	Unconfigured
Relay or Logic Output	
Alarm 1	
H	High alarm
L	Low alarm
R	Rate-of change - Rising
N	New alarm flag
O	Sensor break
P	Power fail
With sensor Break	
7	High alarm
8	Low alarm
9	Rate-of change
With power Fail	
A	High alarm
B	Low alarm
C	Rate-of change
With sensor Break and power fail	
E	High alarm
F	Low alarm
G	Rate-of change

OP2/OP3	
X	Unconfigured
Analogue Output	
PV Retransmission	
1	4-20mA
2	0-20mA
3	0-5Vdc
4	1-5Vdc
5	0-10Vdc
6	2-10Vdc

For 3216i see additional codes on the following page



OP4 (AA Relay)	
X	Unconfigured
Alarm 4	
H	High alarm
L	Low alarm
R	Rate-of change-Rising
N	New alarm flag
O	Sensor break
P	Power fail
With sensor Break	
7	High alarm
8	Low alarm
9	Rate-of change
With power fail	
A	High alarm
B	Low alarm
C	Rate-of change
With sensor Break and power fail	
E	High alarm
F	Low alarm
G	Rate-of change

Digital input A and B	
X	Unconfigured
(Dig in A not available on 32h8i/SG)	
W	Alarm acknowledge
K	Keylock
U	Remote up button
D	Remote down button
V	Recipe 2/1 select
J	Alarm Inhibit
M	Peak Reset
Y	Freeze PV
T	Tare correction
Z	Automatic zero and span calibration – 32h8i/SG only

Additional Quick Codes for 3216i - SET 2



I K

OP2	
Relay or Logic Output	
Alarm 2 (3216i only)	
H	High alarm
L	Low alarm
R	Rate-of change-Rising
N	New alarm flag
O	Sensor break
P	Power fail
With Sensor break	
7	High alarm
8	Low alarm
9	Rate-of change
With power Fail	
A	High alarm
B	Low alarm
C	Rate-of change with sensor break and power fail
With Sensor break and power Fail	
E	High alarm
F	Low alarm
G	Rate-of change

OP1	
Analogue Output	
PV Retransmission (3216i only)	
1	4-20mA
2	0-20mA
Logic Output	
Digital input (3216i)	
W	Alarm acknowledge
K	Keylock
U	Remote up button
D	Remote down button
V	Recipe 2/1 select

4.1.1 To Re-Enter Quick Code Mode

If you need to re-enter the 'Quick Configuration' mode this can always be done as follows:-

1. Power down the indicator
2. Hold  button down and power up the indicator again. Keep the button pressed until you are requested to enter a passcode.
3. Enter a passcode using the  or  buttons. In a new indicator the passcode defaults to 4. If an incorrect passcode is entered you must repeat the whole procedure.

☺ Parameters may also be configured using a deeper level of access. This is described in the 3200i Engineering Handbook Part No. HA029006. This may be downloaded from www.eurotherm.co.uk.

4.2 Pre-Configured Controller or Subsequent Starts

A brief start up sequence consists of a self test in which all elements of the display are illuminated and the software version number is shown.

The indicator will briefly show the quick codes during start up, then proceed to **Operator Level 1**.

You will see the display shown below. It is called the HOME display.

32h8i example



☺ If the Quick Codes do not appear during start up, this means that the indicator has been configured in a deeper level of access, see previous note. The quick codes may then not be valid and are therefore not shown.

4.3 Front panel layout



Beacons:-

ALM	Alarm active (Red)
OP1	Lit when output 1 is ON
OP2	This appears in 3216i only and is lit when output 2 is ON
OP3	Lit when output 3 is configured to retransmit the process value
OP4	Lit when output 4 is ON
REM	Communications active

Operator Buttons:-



From any display - press to return to the HOME display.



Press to select a new parameter. Hold down to continuously scroll through parameters.



Press to change or decrease a value.



Press to change or increase a value.



Message Centre

A scrolling message may appear in this section. For example, if a high alarm is configured to operate output 1, and a low alarm is configured to operate output 4, the scrolling messages 'ALARM 1 HIGH' and 'ALARM 4 LOW' are shown together with the beacons 'ALM', 'OP1' and 'OP4'. 'ALM' flashes if the alarm has not been acknowledged.

If the input sensor is broken '5br' appears in the top display and the scrolling message 'INPUT SENSOR BROKEN' appears in the message centre.

4.3.1 Alarm Indication

Up to four alarms can be configured. If any alarm occurs, the red ALM beacon will flash. A scrolling text message will describe the source of the alarm, for example **ALARM 1 HIGH**. Any output attached to the alarm will operate.

Press  and  (**Ack**) together to acknowledge the alarm

If the alarm is still present the ALM beacon will light continuously.

By default alarms are configured as non-latching, de-energised in alarm. If you require latched alarms, please refer to the engineering handbook.

4.3.2 Out of Range Indication

If the input is too high HHHHH will be displayed

If the input is too low LLLLL will be displayed

4.3.3 Sensor Break Indication

An alarm condition (**S.br**) is indicated if the sensor or the wiring between sensor and controller becomes open circuit.

For a PRT input, sensor break is indicated if any one of the three wires is broken.

For mA input sensor break will not be detected due to the load resistor connected across the input terminals.

For Volts input sensor break may not be detected due to the potential divider network connected across the input terminals.

4.4 Operator Parameters in Level 1

Operator level 1 is designed for day to day operation of the indicator and access to these parameters is not protected by a pass code.

Press  to step through the list of parameters. The mnemonic of the parameter is shown in the lower display. After five seconds a scrolling text description of the parameter appears.

The value of the parameter is shown in the upper display. In level 1 the value is read only.



The parameters that appear depend upon the functions configured. They are:-

Parameter Mnemonic	Scrolling text and Description	Availability	
<i>HIGH</i>	PEAK HIGH	This is the highest reading that the indicator has recorded since switch on or since it was reset	
<i>LOW</i>	PEAK LOW	This is the lowest reading that the indicator has recorded since switch on or since it was reset	
<i>TARE</i>	TARE FUNCTION Linear inputs only See also section 4.4.1.	<i>OFF</i>	No tare correction
		<i>On</i>	Select to automatically correct for tare weight
		<i>FR, L</i>	Displayed if tare correction cannot be made
<i>R1</i> {----}	ALARM 1 SETPOINT	{----} shows the type of alarm configured. For example HI, LO, ROC. This parameter sets the alarm thresholds.	
<i>R2</i> {----}	ALARM 2 SETPOINT		
<i>R3</i> {----}	ALARM 3 SETPOINT		
<i>R4</i> {----}	ALARM 4 SETPOINT		

4.4.1 Tare Correction

Tare correction can be made in Operator Level 1. It is used, for example, when it is required to weigh the contents of a container but not the container itself.

The procedure is to place the empty container on the weigh bridge and 'zero' the indicator. Since it is likely that following containers will have different tare weights the tare function is available in operator level 1.

1. With the empty container placed on the weigh cell, repeatedly press  until *TARE* is displayed.
2. Press  or  to select *0n*
3. The weight of the container will automatically be taken from the total weight.
4. *FA, L* will be displayed if the tare function fails, for example, if the weight is outside the high and low limits or a sensor break condition occurs. In this case correct the fault and repeat the procedure.

Alternatively, a digital input may have been set by selecting T in the quick codes (section 4.1) to provide this function via an external source such as a switch or pushbutton. In this case pressing the button will have the same effect as selecting '*0n*' in 2 above.

5. Operator Level 2

Level 2 provides access to additional parameters. It is protected by a security code.

5.1 To Enter Level 2



1. From any display press and hold .

2. After a few seconds the display will show:-



3. Release .



(If no button is pressed for 45 seconds the display returns to the HOME display)

4. Press  or  to choose **LEu 2** (Level 2)



5. After 2 seconds the display will show:-





6. Press  or  to enter the pass code. Default = '2'



7. If an incorrect code is entered the indicator reverts to Level 1.



5.1.1 To Return to Level 1

1. Press and hold .
2. Press  to select **LEu 1**



The indicator will return to the level 1 HOME display. Note: A pass code is not required when going from a higher level to a lower level.

5.2 Level 2 Parameters

As in Level 1, press  to step through the list of parameters. The mnemonic of the parameter is shown in the message centre. After five seconds a scrolling text description of the parameter appears.

The value of the parameter is shown in the upper display. Press  or  to adjust this value.

If no key is pressed for 30 seconds the controller returns to the HOME display.

Backscroll is achieved when you are in this list by repeatedly pressing  while holding down .

To return to the HOME display at any time, press .

The following table shows a list of parameters available in Level 2.

Mnemonic	Scrolling Display and description		Range
<i>PRST</i>	PEAK RESET Select <i>On</i> to reset the HIGH and LOW peak values. The display automatically returns to <i>OFF</i>		<i>OFF</i> <i>On</i>
<i>HIGH</i>	PEAK HIGH This is the highest reading that the indicator has recorded since switch on or since it was reset		Read only
<i>LOW</i>	PEAK LOW This is the lowest reading that the indicator has recorded since switch on or since it was reset		Read only
<i>TARE</i>	TARE FUNCTION Linear inputs only See also section 4.4.1.	<i>OFF</i> <i>On</i> <i>FR, L</i>	No tare correction Select to automatically correct for tare weight Displayed if the tare correction cannot be made

Continued on next page ▼

Mnemonic	Scrolling Display and description		Range	
SG.TYP	STRAIN GAUGE CALIBRATION TYPE Select the calibration for the type of sensor in use.		SHNT	Strain gauge bridge
			COMP	Comparison
			CELL	Load cell
SHUNT	SHUNT CALIBRATION To set the high calibration point for a bridge type strain gauge or pressure transducer.		OFF or 400 to 1000%	
LOWCAL	STRAIN GAUGE LOW CAL 32h8i/SG only. See also section 5.3.			
HICAL	STRAIN GAUGE HIGH CAL 32h8i/SG only. See also section 5.3.			
AUT SG	STRAIN GAUGE AUTO CAL 32h8i/SG only. See also section 5.3.5.	No YES	Perform automatic strain gauge calibration	
R1 (----)	ALARM 1 SETPOINT		(----) shows the type of alarm configured. For example HIGH, LOW,	
R2 (----)	ALARM 2 SETPOINT			
R3 (----)	ALARM 3 SETPOINT			
R4 (----)	ALARM 4 SETPOINT			
ADDR	ADDRESS Digital communications address for the instrument		1 to 254	
HOME	HOME DISPLAY This configures the parameter which will be displayed in the HOME display in normal operation		PV ALM PVAL PARO	Process variable Alarm setpoint PV + Alarm SP PV + Alarm SP read only
Continued on next page ▼				

Mnemonic	Scrolling Display and description	Range	
<i>ID</i>	CUSTOMER ID Customised instrument identification number	<i>0</i> to <i>9999</i>	
<i>REC.NO</i>	CURRENT RECIPE NUMBER The recipe currently in use. See also section 5.4	<i>nonE</i> <i>1 - 5</i> <i>FR, L</i>	No recipe 1 to 5 selected Fail is shown if no recipe is saved
<i>STORE</i>	RECIPE TO SAVE See also section 5.4	<i>nonE</i> <i>1 - 5</i> <i>donE</i>	No recipe to store 1 to 5 Recipe saved
Continued on next page ▼			

Mnemonic	Scrolling Display and description				Range	
<i>UNITS</i>	DISPLAY UNITS The display units are shown in the top right hand corner of the display in normal operation. Units available are:-					
	$^{\circ}\text{C}$	$^{\circ}\text{C}$	$^{\circ}\text{F}$	$^{\circ}\text{F}$	$^{\circ}\text{K}$	Kelvin
	<i>nonE</i>	No units displayed	<i>PERC</i>	Percentage	<i>PA</i>	Pascals *
	<i>mPA</i>	Mpascals *	<i>kPA</i>	Kpascals *	<i>bAr</i>	Bar *
	<i>mbAr</i>	milli Bar *	<i>PSI</i>	PSI *	<i>kg/cm</i>	kg/sq cm *
* These units only appear in 32h8i indicators	<i>mmwG</i>	mm water gauge *	<i>inwG</i>	Inches water gauge *	<i>mmHg</i>	mm mercury *
	<i>Torr</i>	Torr *	<i>L-H</i>	Litres per hour *	<i>L-m</i>	Litres per minute *
	<i>Ph</i>	%Relative humidity*	<i>PO2</i>	% O2 *	<i>PCO2</i>	% CO2 *
	<i>PCP</i>	% carbon potential*	<i>Volts</i>	Volts *	<i>AmP</i>	Amps *
	<i>mA</i>	milli amps *	<i>mV</i>	milli volts *	<i>Ohm</i>	Ohms *
	<i>PPm</i>	Parts per million *	<i>rPm</i>	Revs per minute *	<i>m-S</i>	milli seconds *
	<i>SEC</i>	Seconds *	<i>mi n</i>	Minutes *	<i>hrS</i>	Hours *
	<i>PH</i>	Ph *	<i>PPH</i>	% Ph *	<i>mPH</i>	Miles per hour *
	<i>mG</i>	milli grams *	<i>GrAm</i>	Grams *	<i>kG</i>	Kilo grams *

☺ Press  at any time to return immediately to the HOME screen at the top of the list.

☺ Hold  down to continuously scroll through the above list

5.3 Strain Gauge Calibration

Different strain gauge transducers may be connected to a 32h8i/SG indicator. It is generally necessary to calibrate the instrument to the transducer in use. This can be done in Operator Level 2 using any one of three methods. These are:-



CELL. Here a load cell is connected directly to the input terminals marked Signal + and - (section 5.3.1).

COMPARISON. The load cell is connected as above but the calibration is compared with a reference device or reference weight (section 5.3.2).

SHUNT. This is so called since it refers to switching a calibration resistor across one arm of a four wire measurement bridge in a strain gauge transducer (section 5.3.3).

The calibration for each of these can be made in Level 2 as described in the following sections.



To configure the different modes:-

In Level 2, press  to scroll to SG.TYP and press  or  to select **CELL**, **COMP** or **Shnt**

5.3.1 Load Cell Calibration

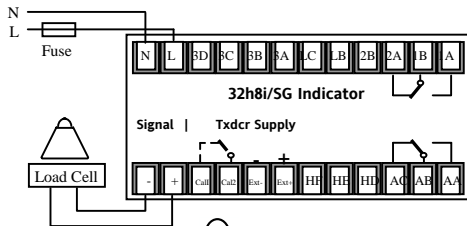
Connect a load cell as shown below:-









1. In Level 2, press  to scroll to LO.CAL.
2. Remove all weight from the load cell and press  or  to select **YES**
3. The indicator will show **buSy** as it calibrates the zero weight condition. **PASS** or **FAI L** will be indicated when the low point calibration is complete.
4. Now add a weight which represents the full scale span of the load cell
5. Repeat the above to calibrate the high point – **HI.CAL.**

5.3.2 Comparison Calibration

Comparison calibration is most appropriate when calibrating the indicator against a second reference device.

The load cell is connected as shown in the previous example.

1. In Level 2, press  to scroll to LO.CAL and press  or  to select **YES**
2. Press  to scroll to the next parameter - C.ADJ (CALIBRATION ADJUST)
3. Press  or  to set the low value calibration point as indicated by the reference device. As soon as the value is entered the indicator will show **buSy** as it calibrates the minimum weight condition. **PASS** or **FAIL** will be indicated when the low point calibration is complete.
4. Repeat the above steps to calibrate the high point - HI.CAL





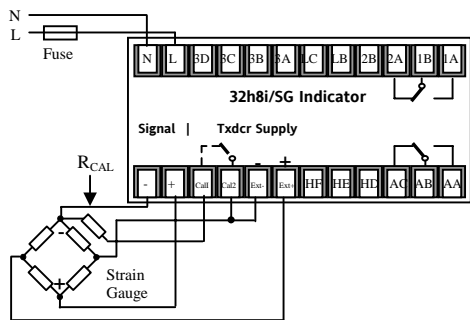

5.3.3 Shunt Calibration

A bridge type strain gauge is connected as shown. Depending on the type of gauge, R_{CAL} may be included internally or supplied as a separate item.





The high (span) and low (zero) adjustment of the transducer can be performed automatically or manually. Manual allows the low point and high point to be calibrated individually. Automatic performs both low and high point calibration by the selection of one parameter.

5.3.4 Manual Calibration

1. Remove all pressure from the transducer to establish a zero reference
2. Press  to scroll to SHUNT and press 
or  to select the high calibration point for the type of sensor in use. This will normally be **80.0%**
3. Press  to scroll to LO.CAL and press 
or  to select **YES**
4. The indicator will show **busy** as it calibrates the minimum weight condition. **PASS** or **FAIL** will be indicated when the low point calibration is complete.
5. Press  to scroll to HI.CAL and repeat the above steps to calibrate the high point - HI.CAL

5.3.5 Automatic Calibration

1. Remove all pressure from the transducer to establish a zero reference
2. In Level 2, press  to scroll to AUT.SG
3. Press  or  to select **YES**

The indicator will automatically perform the following sequence:-

- a. Disconnect the calibration resistor R_{CAL}
- b. Calculate the low point calibration value by continuously averaging two sets of 50 measurements of the input until stable readings are obtained. **Lo** will be indicated during this process.
- c. Connect the calibration resistor by closing a contact between terminals VI and LA
- d. Calculate the high point calibration value by continuously averaging two sets of 50 measurements of the input until stable readings are obtained. **Hi** will be indicated during this process.

5.3.6 Calibration Using a Digital Input

A digital input may have been set by selecting Z in the quick codes (section 4.1) to allow the transducer to be calibrated automatically via an external source such as a switch or pushbutton. In this case pressing the button will have the same effect as selecting **YES** in 3 above.

5.3.6.1 Fail

Fail will be displayed in any of the above calibration procedures if the calibration is not possible. For example, the input shows Sensor Break or is out of range or the transducer or load cell is not connected correctly. It is necessary to correct the fault and start the procedure again.

5.4 Recipes

It is possible to store operating values in up to five different recipes by taking a snapshot of the current settings and storing these in a recipe number.

Examples, of typical operating parameters may be alarm setpoint values. A particular recipe number may then be recalled for a particular process.

5.4.1 To Store Values in a Recipe

1. In the list of parameters, press  to select *STORE*
2. Select a recipe number from 1 to 5 in which to store the current settings. The indicator will show *done* when the values are stored. All previous values which may have been stored in this recipe are overwritten.

5.4.2 To Load a Recipe

1. In the list of parameters, press  to select *REC.NO*
2. Select a recipe number from 1 to 5 in which the required settings have been stored. The values will automatically be loaded from the recipe. If no values have been stored in that recipe, *FAIL* will be indicated.

 This indicator meets the European directives on safety and EMC

INTERNATIONAL SALES AND SERVICE

AUSTRALIA Sydney

Eurotherm Pty. Ltd.
Telephone (+61 2) 9838 0099
Fax (+61 2) 9838 9288
E-mail info@eurotherm.com.au

AUSTRIA Vienna

Eurotherm GmbH
Telephone (+43 1) 7987601
Fax (+43 1) 7987605
E-mail eurotherm@eurotherm.at

BELGIUM & LUXEMBURG Huy

Eurotherm S.A./N.V.
Telephone (+32) 85 274080
Fax (+32) 85 274081
E-mail sales@eurotherm-belgium.be

BRAZIL Campinas-SP

Eurotherm Ltda.
Telephone (+5519) 3707 5333
Fax (+5519) 3707 5345
E-mail eurothermltda@eurothermltda.com.br

DENMARK Copenhagen

Eurotherm Danmark A/S
Telephone (+45 70) 234670
Fax (+45 70) 234660
E-mail info@eurotherm.se

FINLAND Abo

Eurotherm Finland
Telephone (+358) 22506030
Fax (+358) 22503201

FRANCE Lyon

Eurotherm Automation SA
Telephone (+33 478) 664500
Fax (+33 478) 352490
E-mail ea@automation.eurotherm.co.uk

GERMANY Limburg

Eurotherm Deutschland GmbH
Telephone (+49 6431) 2980
Fax (+49 6431) 298119
E-mail info@regler.eurotherm.co.uk

HONG KONG & CHINA

Eurotherm Limited Aberdeen
Telephone (+85 2) 28733826
Fax (+85 2) 28700148
E-mail eurotherm@eurotherm.com.hk

Guangzhou Office

Telephone (+86 20) 8755 5936
Fax (+86 20) 8755 5831

Beijing Office

Telephone (+86 10) 6762 0936
Fax (+86 10) 6762 0931

Shanghai Office

Telephone (+86 21) 6352 6406
Fax (+86 21) 6352 7351

INDIA Chennai

Eurotherm India Limited
Telephone (+9144) 24961129
Fax (+9144) 24961831
E-mail sales@eurothermdel.com

IRELAND Dublin

Eurotherm Ireland Limited
Telephone (+353 1) 469180
Fax (+353 01) 4691300
E-mail info@eurotherm.ie

ITALY Como

Eurotherm S.r.l.
Telephone (+39 31) 975111
Fax (+39 31) 977512
Telex 380893 EUROTH I
E-mail info@eurotherm.it

KOREA Seoul

Eurotherm Korea Limited
Telephone (+82 31) 2738507
Fax (+82 31) 2738508
E-mail help@eurotherm.co.kr

NETHERLANDS Alphen a/d Ryn

Eurotherm B.V.
Telephone (+31 172) 411752
Fax (+31 172) 417260
E-mail sales@eurotherm.nl

NORWAY Oslo

Eurotherm A/S
Telephone Oslo (+47 67) 592170
Fax (+47 67) 118301
E-mail info@eurotherm.se

SPAIN Madrid

Eurotherm España SA
Telephone (+34 91) 6616001
Fax (+34 91) 6619093
E-mail ventas@iberica.eurotherm.co.uk

SWEDEN Malmo

Eurotherm AB
Telephone (+46 40) 384500
Fax (+46 40) 384545
E-mail info@eurotherm.se

SWITZERLAND Freienbach

Eurotherm Produkte (Schweiz) AG
Telephone (+41 55) 4154400
Fax (+41 55) 4154415
E-mail epsag@eurotherm.ch

UNITED KINGDOM Worthing

Eurotherm Limited
Telephone (+44 1903) 268500
Fax (+44 1903) 265982
E-mail info@eurotherm.co.uk
Web www.eurotherm.co.uk

U.S.A Leesburg VA

Eurotherm Inc.
Telephone (+1 703) 443 0000
Fax (+1 703) 669 1300
E-mail info@eurotherm.com
Web www.eurotherm.com

ED43

© Copyright Eurotherm Limited 2005

All rights are strictly reserved. No part of this document may be reproduced, modified, or transmitted in any form by any means, nor may it be stored in a retrieval system other than for the purpose to act as an aid in operating the equipment to which the document relates, without the prior written permission of Eurotherm limited.

Eurotherm Limited pursues a policy of continuous development and product improvement. The specifications in this document may therefore be changed without notice. The information in this document is given in good faith, but is intended for guidance only. Eurotherm Limited will accept no responsibility for any losses arising from errors in this document.

HA029005/1 CN21593



<http://www.eurotherm.co.uk>