

PCA T5 EXCEL one4all Ip x!tec II, 14 – 80 W EXCEL T5

Product description

- Processor-controlled ballast with x!tec II inside
- Highest possible energy class CELMA EEI = A1 BAT[®]
- Noise-free precise control via DALI or DSI signal, switchDIM or corridorFUNCTION
- Nominal life up to 100,000 h (at ta 50 °C with a failure rate max. 0.2 % per 1,000 h)
- Multi-lamp management
- OEM-specific reserved memory areas
- Extended DALI commands
- 5 years guarantee

Interfaces

- DALI
- DSI
- switchDIM (with memory function + selectable dimming rate)
- corridorFUNCTION (3 preprogrammed profiles + individually programmable)
- Integrated SMART interface for function with all SMART Sensors and SMART plugs of the x!tec II range

Functions

- Intelligent Temperature Guard (overtemperature protection)
- Intelligent Voltage Guard (overvoltage indication and undervoltage shutdown)
- Optimum filament heating in any dimmer setting
- Disconnection of filament heating from a dimming level of approx. 90 % for maximum energy efficiency (SMART-Heating concept)
- Fade rates between 100 ms and 90 s (min. – max.)
- corridorFUNCTION with ambient light control
- Automatically triggered emergency lighting value in DC mode 15 %, can be set between 1 and 100 %
- For emergency lighting systems as per EN 50172
- Automatic start after replacement of defective lamps
- Automatic shutdown if the lamp is faulty
- Dimming possible in DC mode

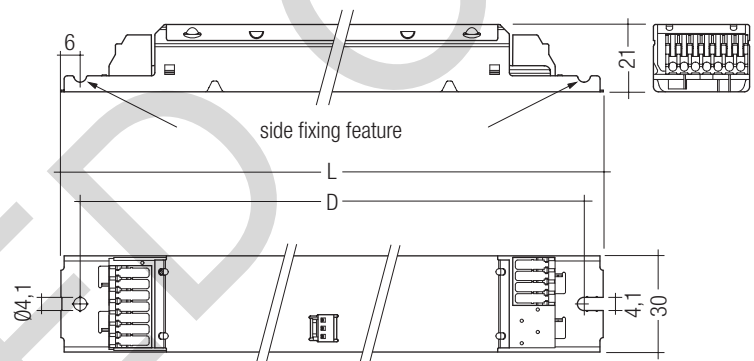

Technical data

Mains voltage range	220 – 240 V
AC voltage range	198 – 264 V
DC voltage range	176 – 280 V (lamp start \geq 198 V DC)
Mains frequency	0 / 50 / 60 Hz
Overvoltage protection	320 V AC, 1 h
Typ. power input on standby	< 0.2 W
Protective hot restart	0.5 s for AC / 0.2 s for DC
Dimming range	1 – 100 %
Lamp start possible from	1 %
Operating frequency	~ 40 – 130 kHz
Type of protection	IP20

Ordering data

Type	Article number	Packaging, carton	Packaging, pallet	Weight per pc.
For luminaires with 1 lamp				
PCA 1x14/24 T5 EXCEL one4all Ip x!tec II	22185103	10 pc(s).	760 pc(s).	0.222 kg
PCA 1x21/39 T5 EXCEL one4all Ip x!tec II	22185110	10 pc(s).	760 pc(s).	0.229 kg
PCA 1x28/54 T5 EXCEL one4all Ip x!tec II	22185108	10 pc(s).	760 pc(s).	0.242 kg
PCA 1x35/49/80 T5 EXCEL one4all Ip x!tec II	22185105	10 pc(s).	760 pc(s).	0.244 kg
For luminaires with 2 lamps				
PCA 2x14/24 T5 EXCEL one4all Ip x!tec II	22185104	10 pc(s).	760 pc(s).	0.264 kg
PCA 2x21/39 T5 EXCEL one4all Ip x!tec II	22185111	10 pc(s).	760 pc(s).	0.262 kg
PCA 2x28/54 T5 EXCEL one4all Ip x!tec II	22185109	10 pc(s).	640 pc(s).	0.335 kg
PCA 2x35/49 T5 EXCEL one4all Ip x!tec II	22185106	10 pc(s).	760 pc(s).	0.258 kg
PCA 2x80 T5 EXCEL one4all Ip x!tec II	22185107	10 pc(s).	640 pc(s).	0.338 kg



Standards, page 3

Wiring diagrams and installation examples, page 8

Specific technical data

Lamp wattage	Lamp type	Type	Article number	Dimensions L x W x H	Hole spacing D	Lamp power ²⁾	Circuit power ²⁾	EEL	Current at 50 Hz 230 V ²⁾	λ at 50 Hz 230 V	tc point max.	Ambient temperature ta ³⁾
For luminaires with 1 lamp												
1 x 14 W	T5	PCA 1x14/24 T5 EXCEL one4all lp xitec II	22185103	360 x 30 x 21 mm	350 mm	14 W	16.0 W	A1 BAT	0.08 A	0.95	80 °C	-25 ... 70 °C
1 x 24 W	T5	PCA 1x14/24 T5 EXCEL one4all lp xitec II	22185103	360 x 30 x 21 mm	350 mm	23 W	25.5 W	A1 BAT	0.12 A	0.97	80 °C	-25 ... 70 °C
1 x 21 W	T5	PCA 1x21/39 T5 EXCEL one4all lp xitec II	22185110	360 x 30 x 21 mm	350 mm	21 W	23.0 W	A1 BAT	0.11 A	0.95	80 °C	-25 ... 70 °C
1 x 36 W	TC-L	PCA 1x21/39 T5 EXCEL one4all lp xitec II	22185110	360 x 30 x 21 mm	350 mm	32 W	35.5 W	A1 BAT	0.16 A	0.96	80 °C	-25 ... 65 °C
1 x 39 W	T5	PCA 1x21/39 T5 EXCEL one4all lp xitec II	22185110	360 x 30 x 21 mm	350 mm	38 W	41.5 W	A1 BAT	0.19 A	0.97	80 °C	-25 ... 65 °C
1 x 40 W	TC-L	PCA 1x21/39 T5 EXCEL one4all lp xitec II	22185110	360 x 30 x 21 mm	350 mm	40 W	43.0 W	A1 BAT	0.20 A	0.98	80 °C	-25 ... 65 °C
1 x 28 W	T5	PCA 1x28/54 T5 EXCEL one4all lp xitec II	22185108	360 x 30 x 21 mm	350 mm	28 W	30.5 W	A1 BAT	0.14 A	0.95	80 °C	-25 ... 75 °C
1 x 54 W	T5	PCA 1x28/54 T5 EXCEL one4all lp xitec II	22185108	360 x 30 x 21 mm	350 mm	54 W	58.0 W	A1 BAT	0.26 A	0.98	80 °C	-25 ... 70 °C
1 x 35 W	T5	PCA 1x35/49/80 T5 EXCEL one4all lp xitec II	22185105	360 x 30 x 21 mm	350 mm	35 W	39.0 W	A1 BAT	0.18 A	0.95	85 °C	-25 ... 75 °C
1 x 49 W	T5	PCA 1x35/49/80 T5 EXCEL one4all lp xitec II	22185105	360 x 30 x 21 mm	350 mm	49 W	53.0 W	A1 BAT	0.25 A	0.97	80 °C	-25 ... 70 °C
1 x 55 W	TC-L	PCA 1x35/49/80 T5 EXCEL one4all lp xitec II	22185105	360 x 30 x 21 mm	350 mm	55 W	60.0 W	A1 BAT	0.28 A	0.97	80 °C	-25 ... 60 °C
1 x 80 W	T5	PCA 1x35/49/80 T5 EXCEL one4all lp xitec II	22185105	360 x 30 x 21 mm	350 mm	80 W	85.5 W	A1 BAT	0.40 A	0.99	80 °C	-25 ... 60 °C
1 x 80 W	TC-L	PCA 1x35/49/80 T5 EXCEL one4all lp xitec II	22185105	360 x 30 x 21 mm	350 mm	80 W	85.5 W	A1 BAT	0.36 A	0.98	80 °C	-25 ... 60 °C
For luminaires with 2 lamps												
2 x 14 W	T5	PCA 2x14/24 T5 EXCEL one4all lp xitec II	22185104	360 x 30 x 21 mm	350 mm	28 W	30.5 W	A1 BAT	0.14 A	0.96	80 °C	-25 ... 70 °C
2 x 18 W	TC-L	PCA 2x14/24 T5 EXCEL one4all lp xitec II	22185104	360 x 30 x 21 mm	350 mm	32 W	38.0 W	A1 BAT	0.15 A	0.96	80 °C	-25 ... 65 °C
2 x 24 W	T5	PCA 2x14/24 T5 EXCEL one4all lp xitec II	22185104	360 x 30 x 21 mm	350 mm	45 W	49.5 W	A1 BAT	0.22 A	0.98	80 °C	-25 ... 65 °C
2 x 24 W	TC-L	PCA 2x14/24 T5 EXCEL one4all lp xitec II	22185104	360 x 30 x 21 mm	350 mm	44 W	49.0 W	A1 BAT	0.21 A	0.98	80 °C	-25 ... 65 °C
2 x 21 W	T5	PCA 2x21/39 T5 EXCEL one4all lp xitec II	22185111	360 x 30 x 21 mm	350 mm	41 W	45.5 W	A1 BAT	0.21 A	0.96	85 °C	-25 ... 70 °C
2 x 36 W	TC-L	PCA 2x21/39 T5 EXCEL one4all lp xitec II	22185111	360 x 30 x 21 mm	350 mm	64 W	71.0 W	A1 BAT	0.31 A	0.98	85 °C	-25 ... 65 °C
2 x 39 W	T5	PCA 2x21/39 T5 EXCEL one4all lp xitec II	22185111	360 x 30 x 21 mm	350 mm	76 W	82.0 W	A1 BAT	0.37 A	0.98	85 °C	-25 ... 65 °C
2 x 40 W	TC-L	PCA 2x21/39 T5 EXCEL one4all lp xitec II	22185111	360 x 30 x 21 mm	350 mm	80 W	86.0 W	A1 BAT	0.40 A	0.99	85 °C	-25 ... 65 °C
2 x 28 W	T5	PCA 2x28/54 T5 EXCEL one4all lp xitec II	22185109	425 x 30 x 21 mm	415 mm	56 W	60.5 W	A1 BAT	0.28 A	0.96	80 °C	-25 ... 70 °C
2 x 54 W	T5	PCA 2x28/54 T5 EXCEL one4all lp xitec II	22185109	425 x 30 x 21 mm	415 mm	108 W	116.5 W	A1 BAT	0.51 A	0.99	85 °C	-25 ... 55 °C
2 x 35 W	T5	PCA 2x35/49 T5 EXCEL one4all lp xitec II	22185106	360 x 30 x 21 mm	350 mm	70 W	74.5 W	A1 BAT	0.34 A	0.97	80 °C	-25 ... 65 °C
2 x 49 W	T5	PCA 2x35/49 T5 EXCEL one4all lp xitec II	22185106	360 x 30 x 21 mm	350 mm	98 W	105.5 W	A1 BAT	0.49 A	0.98	85 °C	-25 ... 60 °C
2 x 55 W	TC-L	PCA 2x80 T5 EXCEL one4all lp xitec II	22185107	425 x 30 x 21 mm	415 mm	110 W	117.0 W	A1 BAT	0.52 A	0.99	80 °C	-25 ... 55 °C
2 x 80 W	T5	PCA 2x80 T5 EXCEL one4all lp xitec II	22185107	425 x 30 x 21 mm	415 mm	160 W	167.0 W	A1 BAT	0.74 A	0.99	80 °C	-25 ... 55 °C

¹⁾ According to the EU directives on ecodesign requirements (EC) No. 245/2009 and (EC) No. 347/2010.

²⁾ Valid at 100 % dimming level.

³⁾ +10 °C to ta max: unrestricted dimming. -25 °C to +10 °C: unrestricted dimming from 100 % to 30 %.

-25 °C to +10 °C, dimming below 30 %: malfunction possible but no damage to ECG. This applies to AC and DC operation.

Standards

EN 55015
EN 60929
EN 61000-3-2
EN 61347-2-3
EN 61547
Suitable for emergency installations according to EN 50172
CISPR 15
CISPR 22
IEC 60929
IEC 61000-3-2
IEC 61347-2-3
IEC 61547
IEC 62386 (according to DALI standard V1)

Lamp starting characteristics

Warm start
Starting time 0.5 s with AC
Starting time 0.2 s with DC
Start at any dimming level

AC operation

Mains voltage
220–240 V 50/60 Hz
198–264 V 50/60 Hz including safety tolerance ($\pm 10\%$)
198–254 V 50/60 Hz including performance tolerance (+6 % / -8 %)

DC operation

220–240 V 0 Hz
198–254 V 0 Hz certain lamp start
176–280 V 0 Hz operating range
Use in emergency lighting installations according to EN 50172 or for emergency luminaires according to EN 61347-2-3 appendix J.

Mains current for defective or missing lamps at DC operation < 35 mA.

Light output level in DC operation

Programmable from 1 % to 100 %
Programming by extended DSI or DALI signal (16 bit).
Default value is 15 %
In DC operation dimming mode can be activated.

Emergency units

The "PCA T5 EXCEL one4all Ip xitec II" ballasts are compatible with all emergency units from Tridonic. See the table in the data sheet. Also all "5-pole" emergency units can be used. When used with other emergency units tests are necessary.

Temperature range

Unlimited dimming range from 10 °C to ta max.
-25 °C to 10 °C: dimming operation from 100 % to 30 %. If dimm level goes below 30 % malfunction possible, but no electronic ballast damage.
This applies to AC and DC operation.

Mains currents in DC operation (at 15 % light output)

Type	Lamp type	Wattage	Mains current at	Mains current at
			$U_n = 220 V_{dc}$	$U_n = 275 V_{dc}$
PCA 1x14/24 T5 EXCEL one4all Ip xitec II	T5	1 x 14 W	0.04 A	0.04 A
	T5	1 x 24 W	0.05 A	0.05 A
	T5	1 x 21 W	0.05 A	0.04 A
PCA 1x21/39 T5 EXCEL one4all Ip xitec II	TC-L	1 x 36 W	0.07 A	0.06 A
	T5	1 x 39 W	0.07 A	0.07 A
	TC-L	1 x 40 W	0.07 A	0.06 A
PCA 1x28/54 T5 EXCEL one4all Ip xitec II	T5	1 x 28 W	0.06 A	0.06 A
	T5	1 x 54 W	0.11 A	0.10 A
	T5	1 x 35 W	0.07 A	0.06 A
PCA 1x35/49/80 T5 EXCEL one4all Ip xitec II	T5	1 x 49 W	0.09 A	0.08 A
	TC-L	1 x 55 W	0.11 A	0.10 A
	T5	1 x 80 W	0.14 A	0.13 A
	TC-L	1 x 80 W	0.13 A	0.12 A
	T5	2 x 14 W	0.07 A	0.06 A
	TC-L	2 x 18 W	0.07 A	0.06 A
PCA 2x14/24 T5 EXCEL one4all Ip xitec II	T5	2 x 24 W	0.10 A	0.09 A
	TC-L	2 x 24 W	0.09 A	0.09 A
	T5	2 x 21 W	0.08 A	0.07 A
PCA 2x21/39 T5 EXCEL one4all Ip xitec II	TC-L	2 x 36 W	0.12 A	0.11 A
	T5	2 x 39 W	0.13 A	0.12 A
	TC-L	2 x 40 W	0.13 A	0.12 A
PCA 2x28/54 T5 EXCEL one4all Ip xitec II	T5	2 x 28 W	0.10 A	0.10 A
	T5	2 x 54 W	0.20 A	0.18 A
	T5	2 x 35 W	0.12 A	0.11 A
PCA 2x35/49 T5 EXCEL one4all Ip xitec II	T5	2 x 49 W	0.16 A	0.15 A
	TC-L	2 x 55 W	0.20 A	0.19 A
PCA 2x80 T5 EXCEL one4all Ip xitec II	T5	2 x 80 W	0.27 A	0.25 A

Ballast lumen factor AC operation (AC-BLF) EN 60929 8.1

Type	Lamp type	Wattage	AC-BLF at
			$U = 230 V_{ac}$
PCA 1x14/24 T5 EXCEL one4all Ip xitec II	T5	1 x 14 W	1.00
	T5	1 x 24 W	1.01
	T5	1 x 21 W	0.99
PCA 1x21/39 T5 EXCEL one4all Ip xitec II	TC-L	1 x 36 W	0.97
	T5	1 x 39 W	1.01
	TC-L	1 x 40 W	1.05
PCA 1x28/54 T5 EXCEL one4all Ip xitec II	T5	1 x 28 W	0.98
	T5	1 x 54 W	1.02
	T5	1 x 35 W	1.00
PCA 1x35/49/80 T5 EXCEL one4all Ip xitec II	T5	1 x 49 W	1.00
	TC-L	1 x 55 W	1.02
	T5	1 x 80 W	1.02
	TC-L	1 x 80 W	1.04
	T5	2 x 14 W	1.01
	TC-L	2 x 18 W	0.90
PCA 2x14/24 T5 EXCEL one4all Ip xitec II	T5	2 x 24 W	1.00
	TC-L	2 x 24 W	0.98
	T5	2 x 21 W	0.97
PCA 2x21/39 T5 EXCEL one4all Ip xitec II	TC-L	2 x 36 W	0.97
	T5	2 x 39 W	0.98
	TC-L	2 x 40 W	1.05
PCA 2x28/54 T5 EXCEL one4all Ip xitec II	T5	2 x 28 W	1.00
	T5	2 x 54 W	1.00
PCA 2x35/49 T5 EXCEL one4all Ip xitec II	T5	2 x 35 W	1.01
	T5	2 x 49 W	1.02
PCA 2x80 T5 EXCEL one4all Ip xitec II	TC-L	2 x 55 W	1.03
	T5	2 x 80 W	1.02

The ballast lumen factor for AC operation (AC-BLF) does not alter from $U_n = 198 V_{ac}$ to $U_n = 254 V_{ac}$.
The ballast lumen factor for DC operation (DC-BLF) on the basis of an automatic power reduction of the ballasts (default value is 15 %) will be smaller than AC. It does not alter in the DC operating range (198–264 V dc).

Dimming

Dimming curve is adapted to the eye sensitiveness.

Dimming range 1 % to 100 %

Digital control with:

- DSI signal: 8 bit Manchester Code
Speed 1 % to 100 % in 1.4 s
- DALI signal: 16 bit Manchester Code
Maximum speed 1 % to 100 % in 550 ms (adjustable between 100 ms and 90 s)
Programmable parameter:
Minimum dimming level
Maximum dimming level
Default minimum = 1 %
Default maximum = 100 %

Control input (DA/D1, DA/D2)

Digital DALI/DSI signal or a push-to-make switch (switchDIM) or a motion detector (corridorFUNCTION) can be wired on the same terminals (DA/D1 and DA/D2).

Digital signal DALI/DSI

The control input is non-polar and protected against accidental connection with a mains voltage up to 264 V. The control signal is not SELV. Control cable has to be installed in accordance to the requirements of low voltage installations.

Different functions depending on each module.

SMART interface

An additional interface for the direct connection of the SMART-Sensoren or SMART-Plugs.

For precise instructions relating to the available sensors and plugs and for a description of how they work in connection with the PCA devices please see the separate documentation for PCA xitec II.

The equipment must be installed in accordance with the relevant directives on low voltage. Ensure that power to the ballast is switched off before connecting or disconnecting the sensors and plugs.

switchDIM

Integrated switchDIM function allows a direct connection of a push to make switch for dimming and switching.

Brief push (< 0.6 s) switches ballast ON and OFF. The ballasts switch-ON at light level set at switch-OFF. After switch ON the last settet dimming level will be activated again.

When the push to make switch is held, PCA ballasts are dimmed. After repush the PCA is dimmed in the opposite direction.

The switchDIM fade time is set to 3 s from min. to max. in the factory settings. With a 20 s push to the push to make switch this fade time can be changed to 6 s. In this instance the switchDIM application will be synchronized to 50 % light level after 10 s and after 20 s the light level rises to 100 % with the new fade time.

At every synchronisation (10 s keystroke) the device will reset to 3 s (factory setting)

In installations with PCAs with different dimming levels or opposite dimming directions (e.g. after a system extension), all PCAs can be synchronized to 50 % dimming level by a 10 s push.

Use of push to make switch with indicator lamp is not permitted.

switchDIM and corridorFUNCTION are very simple tools for controlling ballasts with conventional momentary-action switches or motion sensors. To ensure correct

Dimming characteristics PCA T5 EXCEL one4all Ip xitec II

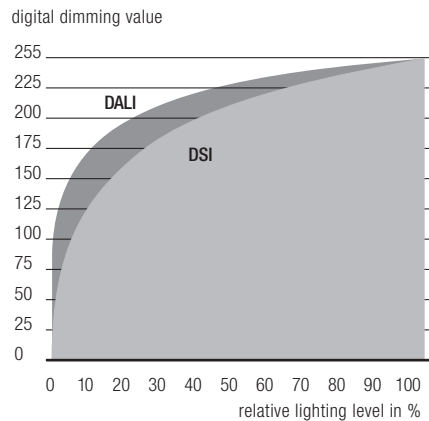

Dimming characteristics as seen by the human eye

operation a sinusoidal mains voltage with a frequency of 50 Hz or 60 Hz is required at the control input. Special attention must be paid to achieving clear zero crossings. Serious mains faults may impair the operation of switchDIM and corridorFUNCTION.

corridorFUNCTION

To activate the corridorFUNCTION a voltage of 230 V simply has to be applied for five minutes at switchDIM connection. The unit will then switch automatically to the corridorFUNCTION.

Note: If the corridorFUNCTION is wrongly activated in a switchDIM system (for example a switch is used instead of pushbutton), there is the option of installing a pushbutton and deactivating the corridorFUNCTION mode by five short pushes of the button within three seconds.

The corridorFUNCTION offers the added benefit of a second and third preprogrammed profile, which can be activated by the SMART-Plugs.

It is also possible to combine the corridorFUNCTION with the SMART-Sensor 5D 19f light sensor.

Application and functionality of profiles see user manual of the corridorFUNCTION.

Energy saving PCA T5 EXCEL one4all Ip xitec II

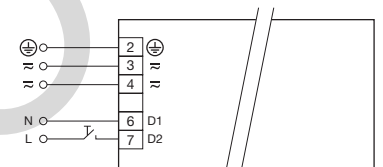
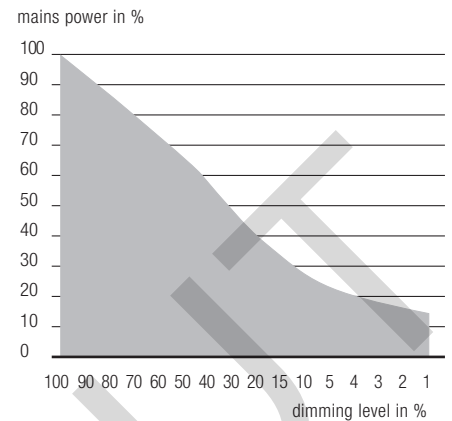

switchDIM PCA T5 EXCEL one4all Ip xitec II

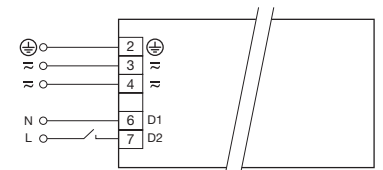

corridorFUNCTION PCA T5 EXCEL one4all Ip xitec II

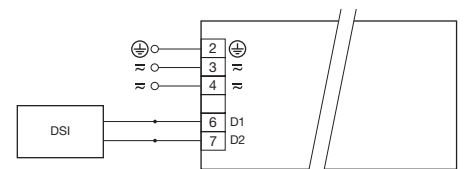

DSI PCA T5 EXCEL one4all Ip xitec II

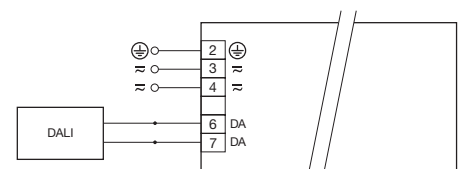

DALI PCA T5 EXCEL one4all Ip xitec II

Loading of automatic circuit breakers (Limitation via inrush current)

Automatic circuit breaker type	C10	C13	C16	C20	B10	B13	B16	B20	Inrush current (1.5 mm ²)		Inrush current (2.5 mm ²)	
	Installation Ø	1.5 mm ²	1.5 mm ²	1.5 mm ²	2.5 mm ²	1.5 mm ²	1.5 mm ²	1.5 mm ²	2.5 mm ²	I _{max}	time	I _{max}
PCA 1x14/24 T5 EXCEL one4all Ip xitec II	50	80	150	180	25	40	75	90	19.3 A	144 µs	19.6 A	147 µs
PCA 1x21/39 T5 EXCEL one4all Ip xitec II	34	50	76	86	17	25	38	43	25.3 A	190 µs	25.1 A	192 µs
PCA 1x28/54 T5 EXCEL one4all Ip xitec II	22	32	46	52	11	16	23	26	26.6 A	235 µs	28.5 A	223 µs
PCA 1x35/49/80 T5 EXCEL one4all Ip xitec II	16	22	28	34	8	11	14	17	31.2 A	271 µs	31.2 A	273 µs
PCA 2x14/24 T5 EXCEL one4all Ip xitec II	22	32	44	50	11	16	22	25	28.1 A	227 µs	28.3 A	227 µs
PCA 2x21/39 T5 EXCEL one4all Ip xitec II	16	22	28	34	8	11	14	17	37.2 A	207 µs	38.8 A	203 µs
PCA 2x28/54 T5 EXCEL one4all Ip xitec II	16	22	30	36	8	11	15	18	28.9 A	288 µs	30.3 A	282 µs
PCA 2x35/49 T5 EXCEL one4all Ip xitec II	16	22	30	34	8	11	15	17	33.0 A	241 µs	33.9 A	240 µs
PCA 2x80 T5 EXCEL one4all Ip xitec II	8	12	18	20	4	6	9	10	48.3 A	261 µs	50.1 A	258 µs

Continuous operation: to calculate the protective safety switch see main current, page 2

Intelligent Voltage Guard

Intelligent Voltage Guard is the name of the electronic monitor from Tridonic. This innovative feature of the PCA family of control gear from Tridonic immediately shows if the mains voltage rises above certain thresholds. Measures can then be taken quickly to prevent damage to the control gear.

- If the mains voltage rises above approx. 318 V_{rms} (voltage depends on the ballast type), the lamp starts flashing on and off.
- To avoid a damage of the device the mains supply has to be switched off at this signal.

Intelligent Temperature Guard

The intelligent temperature guard protects the PCA T5 EXCEL one4all Ip xitec II from thermal overheating by reducing the output power or switching off in case of operation above the thermal limits of the luminaire or ballast. Depending on the luminaire design, the ITG operates at about 5 to 10 °C above to temperature.

Harmonic distortion in the mains supply (at 230 V/50 Hz)

Type	Lamp type	Wattage	THD	3	5	7	9	11
PCA 1x14/24 T5 EXCEL one4all Ip xrttec II	T5	1 x 14 W	9	6	3	3	1	1
	T5	1 x 24 W	9	6	2	3	1	1
	T5	1 x 21 W	9	4	3	2	2	2
PCA 1x21/39 T5 EXCEL one4all Ip xrttec II	TC-L	1 x 36 W	8	4	2	1	1	1
	T5	1 x 39 W	7	4	2	1	1	1
	TC-L	1 x 40 W	6	4	1	1	1	1
PCA 1x28/54 T5 EXCEL one4all Ip xrttec II	T5	1 x 28 W	10	4	2	2	2	2
	T5	1 x 54 W	6	4	1	1	1	1
	T5	1 x 35 W	10	6	2	3	3	3
PCA 1x35/49/80 T5 EXCEL one4all Ip xrttec II	T5	1 x 49 W	10	8	3	3	2	2
	TC-L	1 x 55 W	7	5	1	1	1	2
	T5	1 x 80 W	6	5	1	1	1	1
PCA 2x14/24 T5 EXCEL one4all Ip xrttec II	TC-L	1 x 80 W	6	5	1	1	1	1
	T5	2 x 14 W	8	1	3	1	1	2
	TC-L	2 x 18 W	7	1	2	1	1	2
PCA 2x21/39 T5 EXCEL one4all Ip xrttec II	T5	2 x 24 W	5	1	2	1	1	1
	TC-L	2 x 24 W	6	1	2	1	1	1
	T5	2 x 21 W	10	7	3	4	4	2
PCA 2x28/54 T5 EXCEL one4all Ip xrttec II	TC-L	2 x 36 W	7	4	1	1	2	1
	T5	2 x 39 W	6	4	1	1	1	1
	TC-L	2 x 40 W	6	4	1	1	1	1
PCA 2x35/49 T5 EXCEL one4all Ip xrttec II	T5	2 x 28 W	10	7	2	2	2	2
	T5	2 x 54 W	8	6	1	1	1	1
	T5	2 x 35 W	9	5	1	1	2	2
PCA 2x80 T5 EXCEL one4all Ip xrttec II	T5	2 x 49 W	7	6	1	1	1	1
	TC-L	2 x 55 W	6	4	2	1	1	1
	T5	2 x 80 W	5	4	2	1	1	1

Operating voltage

Type	Lamp type	Wattage	U _{out}
PCA 1x14/24 T5 EXCEL one4all Ip xrttec II	T5	1 x 14 W	430 V
	T5	1 x 24 W	430 V
	T5	1 x 21 W	430 V
PCA 1x21/39 T5 EXCEL one4all Ip xrttec II	TC-L	1 x 36 W	430 V
	T5	1 x 39 W	430 V
	TC-L	1 x 40 W	430 V
PCA 1x28/54 T5 EXCEL one4all Ip xrttec II	T5	1 x 28 W	430 V
	T5	1 x 54 W	430 V
	T5	1 x 35 W	430 V
PCA 1x35/49/80 T5 EXCEL one4all Ip xrttec II	T5	1 x 49 W	430 V
	TC-L	1 x 55 W	430 V
	T5	1 x 80 W	430 V
PCA 2x14/24 T5 EXCEL one4all Ip xrttec II	TC-L	1 x 80 W	430 V
	T5	2 x 14 W	430 V
	TC-L	2 x 18 W	430 V
PCA 2x21/39 T5 EXCEL one4all Ip xrttec II	T5	2 x 24 W	430 V
	TC-L	2 x 24 W	430 V
	T5	2 x 21 W	430 V
PCA 2x28/54 T5 EXCEL one4all Ip xrttec II	TC-L	2 x 36 W	430 V
	T5	2 x 39 W	430 V
	TC-L	2 x 40 W	430 V
PCA 2x35/49 T5 EXCEL one4all Ip xrttec II	T5	2 x 28 W	430 V
	T5	2 x 54 W	430 V
	T5	2 x 35 W	430 V
PCA 2x80 T5 EXCEL one4all Ip xrttec II	T5	2 x 49 W	430 V
	TC-L	2 x 55 W	430 V
	T5	2 x 80 W	430 V

Humidity: 5 % up to max. 85 %,
not condensed
(max. 56 days/year at 85 %)

Storage temperature: -40 °C up to max. +80 °C

The devices have to be within the specified temperature range (ta) before they can be operated.

Expected lifetime

Type	Lamp type	Wattage		ta = 40 °C	ta = 50 °C	ta = 60 °C
PCA 1x14/24 T5 EXCEL one4all lp x:tec II	T5	1 x 14 W	tc	55 °C	65 °C	75 °C
			Lifetime	> 100,000 h	> 100,000 h	> 100,000 h
	T5	1 x 24 W	tc	55 °C	65 °C	75 °C
			Lifetime	> 100,000 h	> 100,000 h	> 100,000 h
PCA 1x21/39 T5 EXCEL one4all lp x:tec II	T5	1 x 21 W	tc	50 °C	60 °C	70 °C
			Lifetime	> 100,000 h	> 100,000 h	> 100,000 h
	TC-L	1 x 36 W	tc	55 °C	65 °C	75 °C
			Lifetime	> 100,000 h	> 100,000 h	> 100,000 h
	T5	1 x 39 W	tc	50 °C	60 °C	70 °C
			Lifetime	> 100,000 h	> 100,000 h	> 100,000 h
	TC-L	1 x 40 W	tc	55 °C	65 °C	75 °C
			Lifetime	> 100,000 h	> 100,000 h	> 100,000 h
PCA 1x28/54 T5 EXCEL one4all lp x:tec II	T5	1 x 28 W	tc	50 °C	60 °C	70 °C
			Lifetime	> 100,000 h	> 100,000 h	> 100,000 h
	T5	1 x 54 W	tc	55 °C	65 °C	75 °C
			Lifetime	> 100,000 h	> 100,000 h	90,000 h
PCA 1x35/49/80 T5 EXCEL one4all lp x:tec II	T5	1 x 35 W	tc	55 °C	65 °C	75 °C
			Lifetime	> 100,000 h	> 100,000 h	> 100,000 h
	T5	1 x 49 W	tc	55 °C	60 °C	70 °C
			Lifetime	> 100,000 h	> 100,000 h	> 100,000 h
	TC-L	1 x 55 W	tc	65 °C	70 °C	80 °C
			Lifetime	> 100,000 h	> 100,000 h	50,000 h
	T5	1 x 80 W	tc	65 °C	70 °C	80 °C
			Lifetime	> 100,000 h	> 100,000 h	50,000 h
TC-L	1 x 80 W	tc	65 °C	70 °C	80 °C	
		Lifetime	> 100,000 h	> 100,000 h	50,000 h	
PCA 2x14/24 T5 EXCEL one4all lp x:tec II	T5	2 x 14 W	tc	50 °C	60 °C	70 °C
			Lifetime	> 100,000 h	> 100,000 h	> 100,000 h
	TC-L	2 x 18 W	tc	55 °C	65 °C	75 °C
			Lifetime	> 100,000 h	> 100,000 h	90,000 h
	T5	2 x 24 W	tc	55 °C	65 °C	75 °C
			Lifetime	> 100,000 h	> 100,000 h	90,000 h
	TC-L	2 x 24 W	tc	55 °C	65 °C	75 °C
			Lifetime	> 100,000 h	> 100,000 h	90,000 h
PCA 2x21/39 T5 EXCEL one4all lp x:tec II	T5	2 x 21 W	tc	55 °C	65 °C	75 °C
			Lifetime	> 100,000 h	> 100,000 h	> 100,000 h
	TC-L	2 x 36 W	tc	60 °C	70 °C	80 °C
			Lifetime	> 100,000 h	> 100,000 h	90,000 h
	T5	2 x 39 W	tc	60 °C	70 °C	80 °C
			Lifetime	> 100,000 h	> 100,000 h	70,000 h
	TC-L	2 x 40 W	tc	60 °C	70 °C	80 °C
			Lifetime	> 100,000 h	> 100,000 h	80,000 h
PCA 2x28/54 T5 EXCEL one4all lp x:tec II	T5	2 x 28 W	tc	55 °C	60 °C	70 °C
			Lifetime	> 100,000 h	> 100,000 h	> 100,000 h
	T5	2 x 54 W	tc	65 °C	75 °C	x
			Lifetime	> 100,000 h	70,000 h	x
PCA 2x35/49 T5 EXCEL one4all lp x:tec II	T5	2 x 35 W	tc	55 °C	65 °C	75 °C
			Lifetime	> 100,000 h	> 100,000 h	80,000 h
	T5	2 x 49 W	tc	65 °C	75 °C	80 °C
			Lifetime	> 100,000 h	80,000 h	50,000 h
PCA 2x80 T5 EXCEL one4all lp x:tec II	TC-L	2 x 55 W	tc	65 °C	75 °C	x
			Lifetime	> 100,000 h	80,000 h	x
	T5	2 x 80 W	tc	65 °C	70 °C	x
			Lifetime	> 100,000 h	80,000 h	x

x = not permitted

Installation instructions

Wiring type and cross section

The wiring can be solid cable with a cross section of 0.5 to 0.75 mm² for push terminal and 0.5 mm² for IDC terminal. For the push-wire connection you have to strip the insulation (8–9 mm).

wire preparation:
0.5 – 0.75 mm²

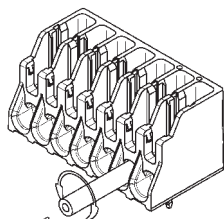
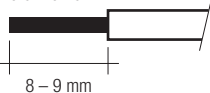

Loosen wire through twisting and pulling

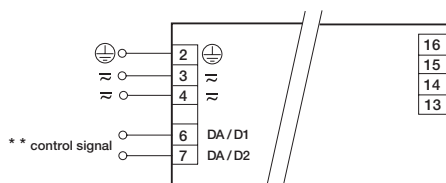

* leads 15, 16: keep wires short, max. 1.0 m
leads 13, 14: max. 2.0 m; ballast must be earthed
** digital signal (DSI), DALI or switchDIM

PCA T5 EXCEL one4all Ip xtec II 1x14–80 W

RFI

- Connection to the lamps of the hot leads must be kept as short as possible
- Mains leads should be kept apart from lamp leads (ideally 5–10 cm distance)
- Do not run mains leads adjacent to the electronic ballast
- Twist the lamp leads
- Keep the distance of lamp leads from the metal work as large as possible
- Mains wiring to be twisted when through wiring
- Keep the mains leads inside the luminaire as short as possible

General advise

Electronic ballasts are virtually noise free. Magnetic fields generated during the ignition cycle can cause some background noise but only for a few milliseconds.

Operation on DC voltage

Our ballasts are construed to operate DC voltage and pulsed DC voltage. To operate ballasts with pulsed DC voltage the polarity is absolute mandatory.

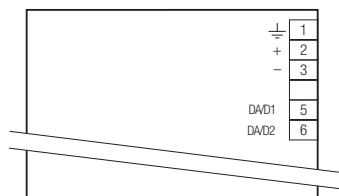

Wiring advice

The lead length is dependent on the capacitance of the cable.

Ballast Type	Terminal	Maximum capacitance allowed			
		Cold	Hot		
PCA 1xx T5 EXCEL one4all Ip xtec II		13, 14	15, 16	200 pF	100 pF
PCA 2xx T5 EXCEL one4all Ip xtec II		12, 13, 14	10, 11, 15, 16	200 pF	100 pF

With standard solid wire 0.5/0.75 mm² the capacitance of the lead is 30–80 pF/m.

This value is influenced by the way the wiring is made.

Lamp connection should be made with symmetrical wiring.

Hot leads (10, 11, 15, 16) and cold leads (12, 13, 14) should be separated as much as possible.

When using two or more dimmable ballasts in one luminaire with separate dimming controls, the lamp leads must be kept separate.

Sensor wires

Sensor wires must be routed separately from the lamp wires and mains cables otherwise the lighting control system may malfunction. If separate routing is not possible (for reasons of space) shielded lamp wires and mains cables must be used.

Dimmable ballasts from Tridonic have to be earthed.

To avoid the damage of the control gear, the wiring must be protected against short circuits to earth (sharp edged metal parts, metal cable clips, louver, etc.).

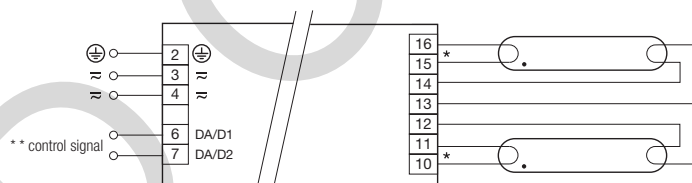

* leads 10, 11, 15, 16: keep wires short, max. 1.0 m
leads 12, 13, 14: max. 2.0 m; ballast must be earthed
** digital signal (DSI), DALI or switchDIM

PCA T5 EXCEL one4all Ip xtec II 2x14–80 W

Dimmable ballasts from Tridonic have to be earthed.

Insulation and electric strength testing of luminaires

Electronic devices can be damaged by high voltage. This has to be considered during the routine testing of the luminaires in production.

According to IEC 60598-1 Annex Q (informative only!) or ENEC 303-Annex A, each luminaire should be submitted to an insulation test with 500 VDC for 1 second. This test voltage should be connected between the interconnected phase and neutral terminals and the earth terminal.

The insulation resistance must be at least 2 MΩ.

As an alternative, IEC 60598-1 Annex Q describes a test of the electrical strength with 1500 VAC (or 1.414 x 1500 Vdc). To avoid damage to the electronic devices this test must not be conducted.

Glow-wire test according to EN 60598-1

650 °C, 750 °C and 850 °C passed

Additional information

Additional technical information at www.tridonic.com → Technical Data

Guarantee conditions at www.tridonic.com → Services

Lifetime declarations are informative and represent no warranty claim.

No warranty if device was opened.

Programming

With appropriate software and a USB interface different functions can be activated and various parameters can be configured in the new PCA TC EXCEL one4all Ip xtec II. All that is needed is a DALI-USB and the software.

Master Configurator

For programming the corridorFUNCTION, device configuration (fade time, ePowerOnLevel, etc.) DC level, compatibility settings, and startup date and for resetting.

Maximum amount of ballast see DALI/DSI specification.

