



Fittings

FITTINGS

Parkrimp (crimp) Series

Field Attachable Series

Visit www.parkerhose.com for 3D CAD drawings.



NPTF

Seal-Lok[®]

Hose
A

Fittings 25 Series
B

Equipment
C

Accessories
D

Technical
E

Parkrimp (crimp) Series of Fittings

25 Series	B-5
26 Series	B-9
43 Series	B-27
70 Series	B-59
71 Series	B-69
73 Series	B-83
76 Series	B-92
78 Series	B-94
S6 Series	B-95
79 Series	B-107
HY Series	B-112
81 Series	B-183

Field Attachable Series of Fittings

20 Series	B-127
21 Series	B-137
22 Series	B-145
23 Series	B-149
30 Series	B-153
42 Series	B-159
82 Series	B-166
88 Series	B-183
TB Series	B-189

How to Read the Fittings Section

With more than 750 end configurations, Parker's brass, stainless steel and Chromium-6 free plated steel fittings include O-ring face seal, flare, straight thread, pipe and metric designs, in both crimp and field attachable styles. Along with Parker hose, all fittings have been tested and approved, and meet stringent industry standards worldwide. Fitting page content is defined by the information shown below. Please take a moment and review.

How to Select Parkrimp Hose Fittings

- Example: 1JC43-12-8C
- 1**JC43-12-8C - Fitting (1=Crimp, 2=Field attachable, 3=Push-Lok, Blank=Nipple with clamp)
 - 1****J**C43-12-8C - End Connection
 - 1**J**C**43-12-8C - Fitting Series
 - 1JC43-**12**-8C - Size of Fitting End Connection
 - 1JC43-12-**8**C - Hose Size
 - 1JC43-12-8**C** - Fitting Material
- No Suffix = Steel
 - B = Brass
 - C = 316 Stainless Steel
 - BA = Brass Nipple with Steel Nut and Socket
 - BS = Brass Nipple with Brass nut and Socket
 - SM = Metric Index

Hose Inner Diameter
Measured in 1/16 inch increments identified by use of a "dash"(-) numbering system. i.e., 4/16" = 1/4" = -4.

"A" Dimension Overall Length

Hex size
Use to determine the wrench size

"B" Dimension
(Cutoff Allowance) Dimension used to determine cut length (C.L.) of hose when making a hose assembly

Catalog 4400 US
Pipe / JIC

26 Series Fittings
Use with 201, 206, 213, 221FR, 225, 244, 266, 265, 293, SS23CG hoses.

Fitting Information
Base part number and end connection description

10126
Male NPTF Pipe - Rigid - Straight

# Part Number	Thread inch	Hose I.D. inch	A		H		B		Additional Material Brass
			inch	mm	inch	mm	inch	mm	
10126-2-4	1/8x27	3/16	1.65	42	7/16	0.78	0.78	20	
10126-4-4	1/4x18	3/16	1.88	48	9/16	1.01	1.01	26	
10126-4-5	1/4x18	1/4	1.88	48	9/16	1.01	1.01	26	
10126-4-6	1/4x18	5/16	1.88	48	3/4	1.02	1.02	26	•
10126-6-6	3/8x18	5/16	1.89	48	11/16	1.03	1.03	26	•
10126-6-8	3/8x18	13/32	1.89	48	11/16	1.03	1.03	26	•
10126-8-8	1/2x14	13/32	2.14	54	7/8	1.28	1.28	33	•
10126-8-10	1/2x14	1/2	2.25	57	7/8	1.30	1.30	33	•
10126-12-12	3/4x14	5/8	2.31	59	1-1/16	1.37	1.37	35	•
10126-16-16	1x11-1/2	7/8	2.61	66	1-3/8	1.57	1.57	40	
10126-20-20	1-1/4x11-1/2	1-1/8	2.83	72	1-3/4	1.77	1.77	45	
10126-24-24	1-1/2x11-1/2	1-3/8	3.01	76	2	1.93	1.93	49	
10126-32-32	2x11-1/2	1-13/16	3.44	87	2-1/2	2.18	2.18	55	

Standard material for fittings is steel. For additional material, refer to column

Indicates Fitting Section

Continued on next page



Hose
A

Fittings 25 Series
B

Equipment
C

Accessories
D

Technical
E

How to Read the Fittings Section

Continued from previous page

How to Select Parkrimp Hose Fittings

Example: 1JC43-12-8C

- 1JC43-12-8C - Fitting (1 = Crimp, 2 = Field Attachable, 3 = Push-Lok, Blank = Nipple with clamp or shell)
- 1JC43-12-8C - End connection (In this case, a female Seal-Lok – swivel – straight)
- 1JC43-12-8C - Fitting series
- 1JC43-12-8C - Size of fitting end connection (In this case, 12/16" or 3/4")
- 1JC43-12-8C - Hose size (In this case, 8/16" or 1/2")
- 1JC43-12-8C - Fitting material:

- No Suffix = Steel
- B = Brass
- C = 316 Stainless Steel
- BA = Brass Nipple with Steel Nut and Socket
- BS = Brass Nipple with Brass Nut and Socket
- SM = Metric Hex



How to Select Two-Piece Field Attachable Fittings

When selecting a two-piece field attachable fitting, the fitting part number (found in Section B of this catalog) needs to be broken down into two distinct numbers for the nipple and the socket.

Example: 20120-16-16B

Socket Part Number

Example: 20020-16B

- 20020-16B - Fitting (1 = Crimp, 2 = Field Attachable, 3 = Push-Lok, Blank = Nipple with clamp or shell)
- 20020-16B - End connection ("00" represents that it is a socket)
- 20020-16B - Fitting series
- 20020-16B - Hose size (In this case, 16/16" or 1")
- 20020-16B - Fitting material:

- No Suffix = Steel
- B = Brass
- C = 316 Stainless Steel
- BA = Brass Nipple with Steel Nut and Socket
- BS = Brass Nipple with Brass Nut and Socket
- SM = Metric Index

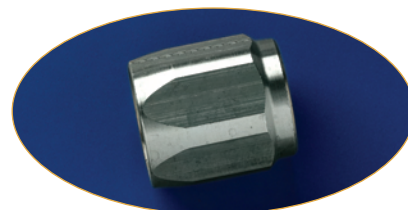

Nipple Part Number

Example: 0120-16-16B

- 0120-16-16B - Fitting (1 = Crimp, 2 = Field Attachable, 3 = Push-Lok, Blank = Nipple with clamp or shell)
- 0120-16-16B - End connection (In this case, a male NPTF Pipe – rigid – straight)
- 0120-16-16B - Fitting series
- 0120-16-16B - Size of fitting end connection (In this case, 16/16" or 1")
- 0120-16-16B - Hose size (In this case, 16/16" or 1")
- 0120-16-16B - Fitting material:

- No Suffix = Steel
- B = Brass
- C = 316 Stainless Steel
- BA = Brass Nipple with Steel Nut and Socket
- BS = Brass Nipple with Brass Nut and Socket
- SM = Metric Index



Hose
A

Fittings 25 Series
B

Equipment
C

Accessories
D

Technical
E

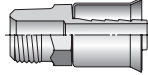
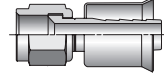
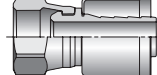
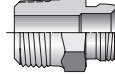
 <p>Flange</p>	10125	B-6	10825	B-6	17B25	B-6	017M	B-6	B-7
									<p>Assembly Instructions</p>
	Rigid		Swivel		Swivel		Swivel		

Hose
A

Fittings 25 Series
B

Equipment
C

Accessories
D

Technical
E

10125 Male NPTF Pipe - Rigid

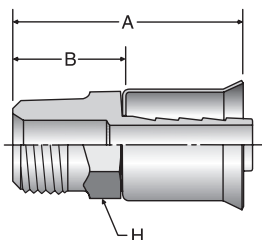

# Part Number	Thread inch	Hose I.D. inch	A		H inch	B	
			inch	mm		inch	mm
10125-6-6B-VS	3/8X18	3/8	1.72	44	11/16	1.00	25
10125-6-8B-VS	3/8X18	1/2	1.72	44	11/16	1.00	25
10125-8-6B-VS	1/2X14	3/8	2.05	52	7/8	1.33	34
10125-8-8B-VS	1/2X14	1/2	2.05	52	7/8	1.33	34

10825 Female SAE 45° - Swivel

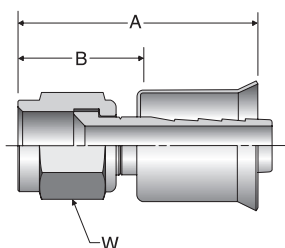

# Part Number	Thread inch	Hose I.D. inch	A		H inch	B	
			inch	mm		inch	mm
10825-6-6B	5/8X18	3/8	1.82	46	3/4	1.10	28
10825-8-6B	3/4X16	3/8	1.80	46	7/8	1.08	27
10825-8-8B	3/4X16	1/2	1.95	50	7/8	1.22	31

17B25 Female Air Brake Jounce Line - Swivel - Straight

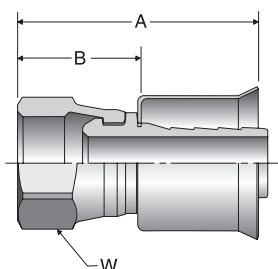

# Part Number	Thread inch	Hose I.D. inch	A		H inch	B	
			inch	mm		inch	mm
17B25-8-6B	3/4X20	3/8	1.59	40	7/8	0.87	22
17B25-8-8B	3/4X20	1/2	1.59	40	7/8	0.87	22

017M Air Brake Adapter

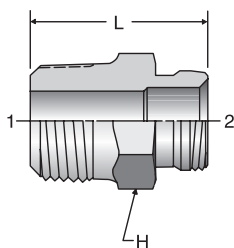

# Part Number	Thread End 1 NPTF inch		Thread End 2 UNEFInch		L		H inch
	inch	mm	inch	mm	inch	mm	
017M-6-8B	6	3/8X18	8	3/4X20	1.13	29	3/4
017M-8-8B	8	1/2X14	8	3/4X20	1.33	34	7/8

Assembly Instructions

1. On the 08 end configurations only, the use of a mandrel is required. This mandrel is designed to set the proper gap between the nut and the shell. To match the correct fitting with the proper mandrel part number refer to the table below.



2. The assembly mandrels can be used with a common bench vise or on the TH2-7 push-on stand. Refer to Bulletin 4480-T13-USA for push-on stand instructions.
3. When using a common bench vise, place the mandrel in the vise, put the fitting on the mandrel (nut first) then push on the hose until it bottoms. Visually check the sight hole on the side of the shell to assure that the hose is fully inserted.
4. Remove mandrel from fitting and check for proper gap between nut and shell. (See table below).
5. Now crimp the fitting onto the hose. Refer to CrimpSource for correct crimp dies and crimping dimensions.
6. Check for proper gap between nut and shell after crimp. (See table below)

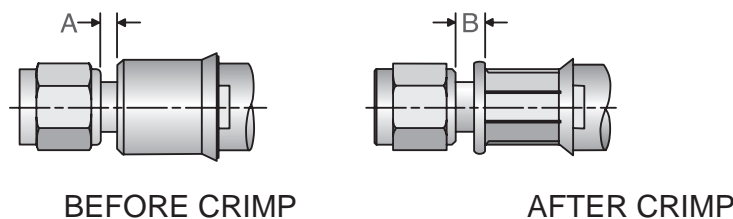

NOTE: B dimension is measured from the back of the fully-seated nut to the start of the crimp length. The nut must be free to swivel after crimping of the shell.

Fitting Part Number	A Length		B Length		Required Assembly Mandrel
	mm	inch	mm	inch	
10625-6-6B	3.80	0.150	8.00	0.315	TH2-7M25-6
10825-6-6B	5.80	0.230	11.80	0.465	
10625-8-8B	3.80	0.150	8.00	0.315	TH2-7M25-8
10825-8-8B	5.80	0.230	11.80	0.465	

NOTE: The "Required Assembly Tool" must be used to assemble all fittings listed above.

7. For all other 25 series fittings, use of mandrel is not necessary. Push fitting onto hose until it bottoms. Visually check sight hole on the side of the shell to assure that the hose is fully inserted.











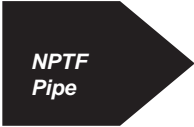
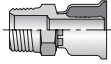

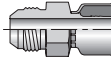
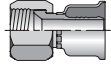
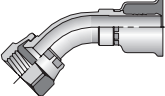
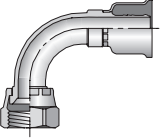

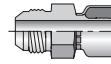
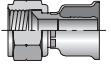
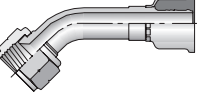
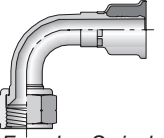

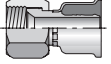
Hose
A

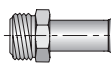
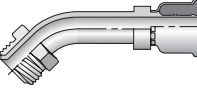
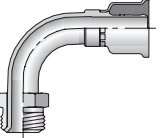
Fittings 25 Series
B

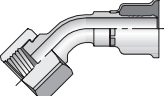
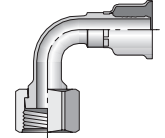
Equipment
C

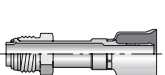
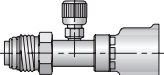
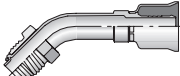
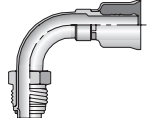
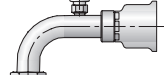
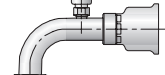
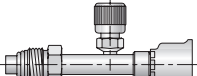
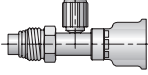
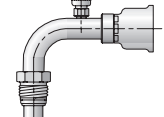
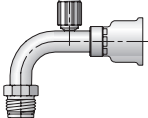
Accessories
D

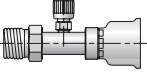
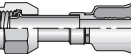
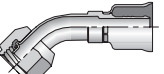
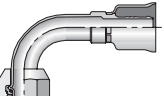
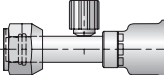
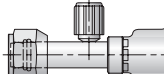
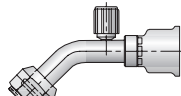
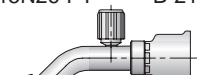
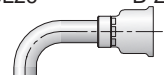
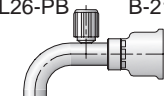
Technical
E

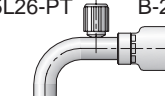
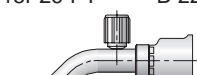
 NPTF Pipe	10126 B-11  <i>Male - Rigid</i>	 JIC 37°	10326 B-11  <i>Male - Rigid</i>	10626 B-12  <i>Female - Swivel</i>	13726 B-12  <i>Female - Swivel 45° Elbow - Short</i>
13926 B-12  <i>Female - Swivel 90° Elbow - Short</i>	14126 B-13  <i>Female - Swivel 90° Elbow - Long</i>	 SAE 45°	10426 B-13  <i>Male - Rigid</i>	10826 B-13  <i>Female - Swivel</i>	17726 B-13  <i>Female - Swivel 45° Elbow</i>
17926 B-14  <i>Female - Swivel 90° Elbow</i>	 JIC 37°/ SAE 45° Dual Flare	16826 B-14  <i>Female - Swivel</i>	 Inverted Flare	12826 B-14  <i>Male - Swivel</i>	16726 B-15  <i>Male - Swivel 45° Elbow</i>
16926 B-15  <i>Male - Swivel 90° Elbow</i>	 Seal-Lok® (O-Ring Face Seal)	1JC26 B-15  <i>Female - Swivel Short</i>	1J726 B-16  <i>Female - Swivel 45° Elbow</i>	1J926 B-16  <i>Female - Swivel 90° Elbow - Short</i>	 Tube-O
1S526 B-16  <i>Male - Swivel Short Pilot</i>	1S526-PR B-17  <i>Male - Swivel Short Pilot</i>	15R26 B-17  <i>Male - Swivel 45° Elbow - Short Pilot</i>	15K26 B-17  <i>Male - Swivel 90° Elbow - Short Pilot</i>	15K26-PB B-17  <i>Male - Swivel 90° Elbow - Short Pilot</i>	15K26-PR B-18  <i>Male - Swivel 90° Elbow - Short Pilot</i>
14526-PR B-18  <i>Male - Swivel Long Pilot</i>	14526-PT B-18  <i>Male - Swivel Long Pilot</i>	15M26-PR B-18  <i>Male - Swivel 90° Elbow - Long Pilot</i>	15M26-PT B-19  <i>Male - Swivel 90° Elbow - Long Pilot</i>	15G26 B-19  <i>Male - Rigid Internal - Long Pilot</i>	15G26-PR B-19  <i>Male - Rigid Internal - Long Pilot</i>
15S26 B-19  <i>Female - Swivel Short Pilot</i>	15H26 B-20  <i>Female - Swivel 45° Elbow - Short Pilot</i>	15T26 B-20  <i>Female - Swivel 90° Elbow - Short Pilot</i>	15926-PB B-20  <i>Female - Swivel Long Pilot</i>	15926-PT B-20  <i>Female - Swivel Long Pilot</i>	15N26-PB B-21  <i>Female - Swivel 45° Elbow - Long Pilot</i>
15N26-PT B-21  <i>Female - Swivel 45° Elbow - Long Pilot</i>	15L26 B-21  <i>Female - Swivel 90° Elbow - Long Pilot</i>	15L26-PB B-21  <i>Female - Swivel 90° Elbow - Long Pilot</i>	15L26-PR B-22  <i>Female - Swivel 90° Elbow - Long Pilot</i>	15L26-PT B-22  <i>Female - Swivel 90° Elbow - Long Pilot</i>	15P26-PT B-22  <i>Male - Swivel 45° Elbow - Long Pilot</i>

Hose
A

Fittings 26 Series
B

Equipment
C

Accessories
D

Technical
E



Hose
A

Fittings 26 Series
B

Equipment
C

Accessories
D

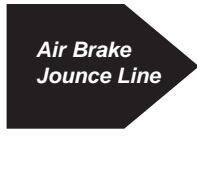
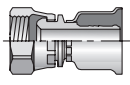
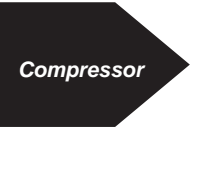
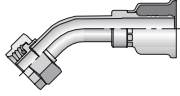
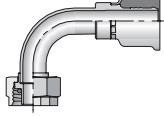
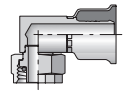
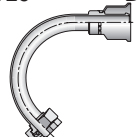
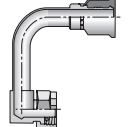
Technical
E

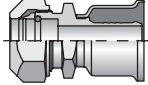
 <p><i>Air Brake Jounce Line</i></p>	<p>17B26 B-22</p>  <p><i>Female - Swivel</i></p>	 <p><i>Compressor</i></p>	<p>15V26 B-23</p>  <p><i>Female - Swivel 45° Elbow</i></p>	<p>15W26 B-23</p>  <p><i>Female - Swivel 90° Elbow</i></p>	<p>15Z26 B-23</p>  <p><i>Female - Swivel 90° Elbow - Block Type</i></p>
<p>1RV26 B-23</p>  <p><i>Female - Swivel 135° Elbow</i></p>	<p>1RZ26 B-24</p>  <p><i>Female - Swivel 180° Elbow</i></p>	 <p><i>Refrigerant Tube Mender</i></p>	<p>1T126 B-24</p>  <p><i>Male (w/Nut & Ferrule)</i></p>	<p>1T126 B-25</p> <p><i>Fitting Assembly Instructions</i></p>	

10126

Male NPTF Pipe - Rigid

# Part Number	Thread		Hose I.D.		A		H		B		Additional Material Brass (B)
	inch		inch	mm	inch	mm	inch	mm	inch	mm	
10126-2-4	1/8x27		3/16	1.65	42	7/16	0.78	0.78	20		
10126-4-4	1/4x18		3/16	1.88	48	9/16	1.01	1.01	26		
10126-4-5	1/4x18		1/4	1.88	48	9/16	1.01	1.01	26		
10126-4-6	1/4x18		5/16	1.88	48	3/4	1.02	1.02	26	•	
10126-6-6	3/8x18		5/16	1.89	48	11/16	1.03	1.03	26	•	
10126-6-8	3/8x18		13/32	1.89	48	11/16	1.03	1.03	26	•	
10126-8-8	1/2x14		13/32	2.14	54	7/8	1.28	1.28	33	•	
10126-8-10	1/2x14		1/2	2.25	57	7/8	1.30	1.30	33	•	
10126-12-12	3/4x14		5/8	2.31	59	1-1/16	1.37	1.37	35	•	
10126-16-16	1x11-1/2		7/8	2.61	66	1-3/8	1.57	1.57	40		
10126-20-20	1-1/4x11-1/2		1-1/8	2.83	72	1-3/4	1.77	1.77	45		
10126-24-24	1-1/2x11-1/2		1-3/8	3.01	76	2	1.93	1.93	49		
10126-32-32	2x11-1/2		1-13/16	3.44	87	2-1/2	2.18	2.18	55		

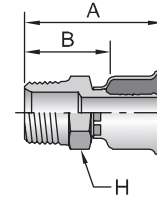

10326

Male JIC 37° - Rigid

# Part Number	Thread		Hose I.D.		A		H		B		Additional Material Brass (B)
	inch		inch	mm	inch	mm	inch	mm	inch	mm	
10326-4-4	1/4	7/16x20	3/16	2.02	50	1/2	1.15	1.15	29	•	
10326-6-6	3/8	9/16x18	5/16	2.12	54	3/4	1.26	1.26	32	•	
10326-8-8	1/2	3/4X16	13/32	1.94	49	13/16	1.08	1.08	27	•	
10326-10-10	5/8	7/8X14	1/2	2.49	64	15/16	1.54	1.54	39	•	
10326-16-16	1	1-5/16x12	7/8	2.79	71	1-3/8	1.75	1.75	44		

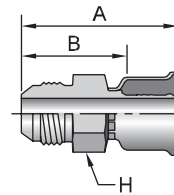

Hose
A

Fittings 26 Series
B

Equipment
C

Accessories
D

Technical
E

Hose
A

Fittings 26 Series
B

Equipment
C

Accessories
D

Technical
E

10626

Female JIC 37° - Swivel

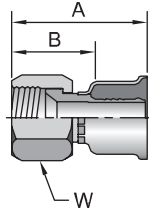

# Part Number	Thread		Hose I.D. inch	A		W inch	B		Additional Material Brass (B)
	inch	mm		inch	mm		inch	mm	
10626-6-6	3/8	9/16x18	5/16	1.81	45	11/16	0.95	23	•
10626-6-8	3/8	9/16x18	13/32	1.67	52	11/16	1.19	30	•
10626-12-12	3/4	1-1/16x12	5/8	2.29	58	1-1/4	1.35	34	•
10626-16-16	1	1-5/16x12	7/8	2.53	64	1-1/2	1.49	38	•
10626-20-20	1-1/4	1-5/8x12	1-1/8	2.56	65	2	1.50	38	•
10626-24-24	1-1/2	1-7/8x12	1-3/8	2.77	70	2-1/4	1.69	43	
10626-32-32	2	2-1/2x12	1-13/16	3.30	84	2-7/8	2.04	52	

13726

Female JIC 37° - Swivel - 45° Elbow - Short Drop

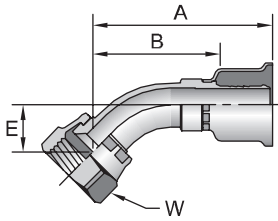

# Part Number	Thread		Hose I.D. inch	A		E		W inch	B	
	inch	mm		inch	mm	inch	mm		inch	mm
13726-4-4	1/4	7/16x20	3/16	2.01	51	0.39	10	9/16	1.14	29
13726-6-6	3/8	9/16x18	5/16	2.72	69	0.43	11	11/16	1.86	47
13726-8-8	1/2	3/4x16	13/32	2.82	72	0.55	14	7/8	1.96	50
13726-10-10	5/8	7/8x14	1/2	2.96	75	0.63	16	1	2.01	51
13726-12-12	3/4	1-1/16x12	5/8	3.44	87	0.83	21	1-1/4	2.50	63
13726-16-16	1	1-5/16x12	7/8	3.34	85	0.90	23	1-1/2	2.30	58
13726-20-20	1-1/4	1-5/8x12	1-1/8	3.74	95	1.18	30	2	2.68	68
13726-24-24	1-1/2	1-7/8x12	1-3/8	3.92	100	1.16	29	2-1/4	2.84	72

13926

Female JIC 37° - Swivel - 90° Elbow - Short Drop

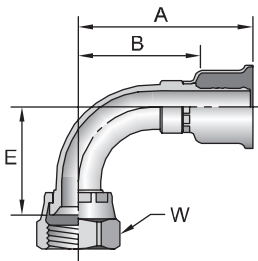

# Part Number	Thread		Hose I.D. inch	A		E		W inch	B	
	inch	mm		inch	mm	inch	mm		inch	mm
13926-4-4	1/4	7/16x20	3/16	1.82	46	0.83	21	9/16	0.95	24
13926-6-6	3/8	9/16x18	5/16	2.15	55	0.91	23	11/16	1.29	33
13926-8-8	1/2	3/4x16	13/32	2.22	56	1.09	28	7/8	1.36	35
13926-10-10	5/8	7/8x14	1/2	2.23	57	1.26	32	1	1.28	33
13926-10-12	5/8	7/8x14	5/8	2.52	64	1.23	31	1	1.58	40
13926-12-12	3/4	1-1/16x12	5/8	2.28	58	1.82	46	1-1/4	1.30	34
13926-16-16	1	1-5/16x12	7/8	3.30	84	2.14	54	1-1/2	2.26	57
13926-20-20	1-1/4	1-5/8x12	1-1/8	3.60	91	2.57	65	2	2.53	65
13926-24-24	1-1/2	1-7/8x12	1-3/8	3.92	100	2.82	72	2-1/4	2.84	72

14126

Female JIC 37° - Swivel - 90° Elbow - Long Drop

# Part Number	Thread		Hose I.D. inch	A		E		W inch	B	
	inch	inch		inch	mm	inch	mm		inch	mm
14126-4-4	1/4	7/16x20	1/4	2.05	52	1.81	46	9/16	1.18	30
14126-6-6	3/8	9/16x18	5/16	2.02	51	2.13	54	11/16	1.16	29
14126-8-8	1/2	3/4X16	13/32	2.35	60	2.43	62	7/8	1.49	38
14126-10-10	5/8	7/8x14	1/2	2.11	54	2.76	70	1	1.16	29
14126-16-16	1	1-5/16x12	7/8	3.17	81	4.33	110	1-1/2	2.13	54

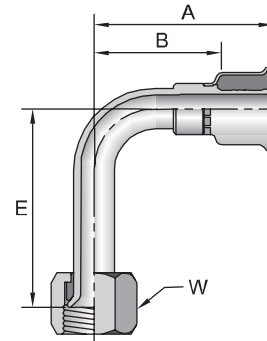

10426

Male SAE 45° - Rigid

# Part Number	Thread		Hose I.D. inch	A		H inch	B	
	inch	inch		inch	mm		inch	mm
10426-4-4	1/4	7/16x20	3/16	1.97	50	1/2	1.18	28
10426-6-6	3/8	5/8x18	5/16	2.04	52	11/16	1.18	30

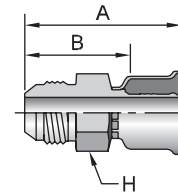

10826

Female SAE 45° - Swivel

# Part Number	Thread		Hose I.D. inch	A		W inch	B		Additional Material Brass (B)
	inch	inch		inch	mm		inch	mm	
10826-6-6	3/8	5/8x18	5/16	1.84	47	3/4	0.98	25	•
10826-10-8	5/8	7/8x14	13/32	2.21	56	1	1.35	34	
10826-10-10	5/8	7/8x14	1/2	2.13	54	1	1.18	30	
10826-12-12	3/4	1-1/16x14	5/8	2.19	56	1-1/4	1.25	32	•

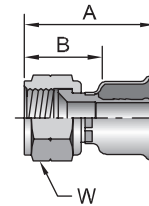

17726

Female SAE 45° - Swivel - 45° Elbow

# Part Number	Thread		Hose I.D. inch	A		E		W inch	B	
	inch	inch		inch	mm	inch	mm		inch	mm
17726-4-4	1/4	7/16x20	3/16	2.29	58	0.39	10	9/16	1.43	36
17726-6-6	3/8	5/8x18	5/16	2.72	69	0.43	11	11/16	1.86	47
17726-8-8	1/2	3/4x16	13/32	2.82	72	0.59	14	7/8	1.96	50
17726-10-10	5/8	7/8x14	1/2	2.96	75	0.63	16	1	2.01	51
17726-12-12	3/4	1-1/16x14	5/8	3.43	87	0.83	21	1-1/4	2.49	63

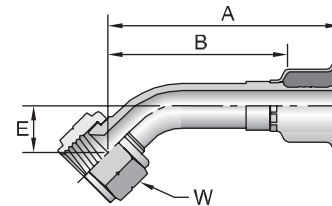

Notch on nut signifies SAE 45° flare fitting.

Hose
A

Fittings 26 Series
B

Equipment
C

Accessories
D

Technical
E

17926

Female SAE 45° - Swivel - 90° Elbow

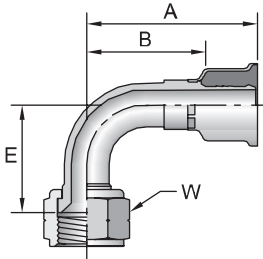

# Part Number	Thread		Hose I.D. inch	A		E		W inch	B	
	inch	mm		inch	mm	inch	mm		inch	mm
17926-4-4	1/4	7/16x20	3/16	1.75	44	0.83	21	9/16	0.89	23
17926-6-6	3/8	5/8x18	5/16	2.15	55	0.91	23	3/4	1.29	33
17926-8-8	1/2	3/4x16	13/32	2.31	58.7	1.00	25.4	7/8	1.45	37
17926-10-10	5/8	7/8x14	1/2	2.23	57	1.26	32	1	1.28	33
17926-12-12	3/4	1-1/16x14	5/8	2.28	58	1.82	46	1-1/4	1.34	34

Notch on nut signifies 45° flare fitting.

16826

Female JIC 37° / SAE 45° - Dual Flare - Swivel

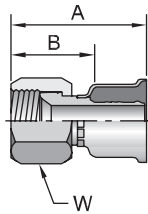

# Part Number	Thread		Hose I.D. inch	A		W inch	B		Additional Material Brass (B)
	inch	mm		inch	mm		inch	mm	
16826-4-4	1/4	7/16x20	3/16	1.67	42	9/16	0.80	20	•
16826-4-5	1/4	7/16x20	1/4	1.55	48	9/16	1.03	26	
16826-4-6	1/4	7/16x20	5/16	1.55	39	9/16	0.07	17	
16826-5-5	5/16	1/2x20	1/4	1.77	45	5/8	0.90	23	
16826-8-6	1/2	3/4x16	5/16	1.76	56	7/8	1.34	34	
16826-8-8	1/2	3/4x16	13/32	1.91	49	7/8	1.05	27	
16826-8-10	1/2	3/4x16	1/2	2.36	60	7/8	1.41	36	•
16826-10-10	5/8	7/8x14	1/2	2.17	55	1	1.23	31	•
16826-10-12	5/8	7/8x14	5/8	1.96	61	1	1.53	37	

12826

Male Inverted SAE 45° - Swivel

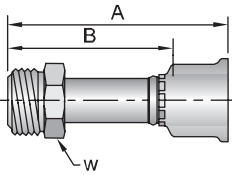

# Part Number	Thread		Hose I.D. inch	A		W inch	B	
	inch	mm		inch	mm		inch	mm
12826-4-4	1/4	7/16x24	3/16	2.43	62	7/16	1.56	40
12826-5-5	5/16	1/2x20	1/4	2.56	65	1/2	1.69	43
12826-6-6	3/8	5/8x18	5/16	2.87	73	5/8	2.01	51
12826-8-8	1/2	3/4x18	13/32	3.00	76	3/4	2.14	54
12826-10-10	5/8	7/8x18	1/2	3.17	81	7/8	2.22	56

See Accessories Section for O-Rings and Flange Kits.

16726

Male Inverted SAE 45° - Swivel - 45° Elbow

# Part Number	Thread		Hose I.D. inch	A		E		W		B	
	inch			inch	mm	inch	mm	inch	mm	inch	mm
16726-4-4	1/4	7/16x24	3/16	2.20	56	0.63	16	7/16	1.33	34	
16726-5-5	5/16	1/2x20	1/4	2.30	58	0.70	18	1/2	1.43	36	
16726-6-6	3/8	5/8x18	5/16	2.55	65	0.87	22	5/8	1.69	43	
16726-8-8	1/2	3/4x18	13/32	2.60	66	1.09	28	3/4	1.74	44	

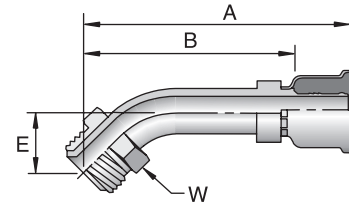

16926

Male Inverted SAE 45° - Swivel - 90° Elbow

# Part Number	Thread		Hose I.D. inch	A		E		W		B	
	inch			inch	mm	inch	mm	inch	mm	inch	mm
16926-4-4	1/4	7/16x24	3/16	2.27	58	1.56	40	7/16	1.40	36	
16926-6-6	3/8	5/8x18	5/16	1.89	48	1.48	38	5/8	1.03	26	
16926-8-8	1/2	3/4x18	13/32	2.25	57	1.88	48	3/4	1.39	35	
16926-10-10	5/8	7/8x18	1/2	2.70	69	2.17	55	7/8	1.75	44	

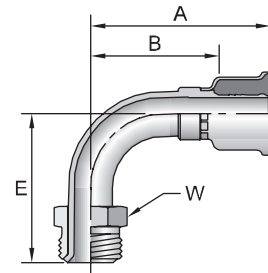

1JC26

Female Seal-Lok® - Swivel - Short

# Part Number	Thread		Hose I.D. inch	A		C		H		W		B	
	inch			inch	mm	inch	mm	inch	mm	inch	mm	inch	mm
1JC26-4-4	1/4	9/16x18	3/16	1.66	42	0.31	8	9/16	11/16	0.79	20		
1JC26-6-6	3/8	11/16x16	5/16	1.70	43	0.34	9	11/16	13/16	0.84	21		
1JC26-8-8	1/2	13/16x16	13/32	1.76	45	0.43	11	13/16	15/16	0.90	23		
1JC26-12-12	3/4	1-3/16x12	5/8	2.13	54	0.55	14	1-1/8	1-3/8	1.19	30		
1JC26-16-16	1	1-7/16x12	7/8	2.39	61	0.56	14	1-3/8	1-5/8	1.35	34		
1JC26-20-20	1-1/4	1-11/16x12	1-1/8	2.45	62	0.59	15	1-7/8	1-7/8	1.39	35		

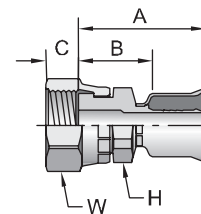

When measuring overall length to the end of the nut, B + C must be used to calculate cut-off allowance.
See Accessories Section for O-Rings.

Hose
A

Fittings 26 Series
B

Equipment
C

Accessories
D

Technical
E

Hose
A

Fittings 26 Series
B

Equipment
C

Accessories
D

Technical
E

1J726

Female Seal-Lok® - Swivel - 45° Elbow

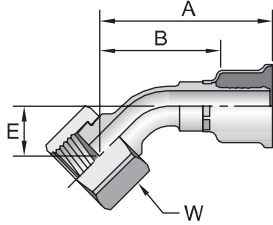

# Part Number	Thread		Hose I.D. inch	A		E		W		B	
	inch	inch		inch	mm	inch	mm	inch	mm	inch	mm
1J726-4-4	1/4	9/16x18	3/16	1.99	51	0.39	10	11/16	1.12	28	
1J726-6-6	3/8	11/16x16	5/16	2.43	62	0.43	11	13/16	1.57	40	
1J726-8-8	1/2	13/16x16	13/32	2.77	70	0.59	15	15/16	1.91	49	
1J726-10-10	5/8	1x14	1/2	3.26	83	0.63	16	1-1/8	2.31	59	
1J726-12-12	3/4	1-3/16x12	5/8	3.13	80	0.83	21	1-3/8	2.19	56	
1J726-16-16	1	1-7/16x12	7/8	3.61	92	0.94	24	1-5/8	2.57	65	
1J726-20-20	1-1/4	1-11/16x12	1-1/8	3.93	100	1.00	25	1-7/8	2.87	73	

1J926

Female Seal-Lok® - Swivel - 90° Elbow - Short Drop

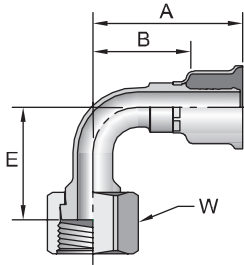

# Part Number	Thread		Hose I.D. inch	A		E		W		B	
	inch	inch		inch	mm	inch	mm	inch	mm	inch	mm
1J926-4-4	1/4	9/16x18	3/16	1.80	46	0.83	21	11/16	0.93	24	
1J926-6-6	3/8	11/16x16	5/16	1.86	47	0.91	23	13/16	1.00	25	
1J926-8-8	1/2	13/16x16	13/32	2.14	54	1.14	29	15/16	1.28	33	
1J926-10-10	5/8	1x14	1/2	2.53	64	1.26	32	1-1/8	1.58	40	
1J926-12-12	3/4	1-3/16x12	5/8	2.51	64	1.89	48	1-3/8	1.57	40	
1J926-16-16	1	1-7/16x12	7/8	3.56	90	2.21	56	1-5/8	2.52	64	
1J926-20-20	1-1/4	1-11/16x12	1-1/8	4.05	103	2.51	64	1-7/8	2.99	76	

1S526

Male Tube-O - Swivel - Short Pilot

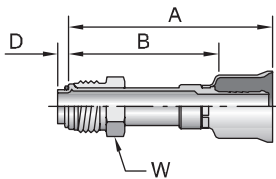

# Part Number	Thread		Hose I.D. inch	A		D		W		B	
	inch	inch		inch	mm	inch	mm	inch	mm	inch	mm
1S526-6-6	3/8	5/8x18	5/16	2.54	65	0.18	4,7	5/8	1.68	43	
1S526-7-6	11/16	11/16x16	5/16	2.57	65	0.18	4,7	5/8	1.71	43	
1S526-8-8	1/2	3/4x18	13/32	2.68	68	0.18	4,7	3/4	1.82	46	
1S526-10-10	5/8	7/8x18	1/2	3.46	88	0.18	4,7	7/8	2.51	64	
1S526-10-12	5/8	7/8x18	5/8	3.63	92	0.18	4,7	7/8	2.69	68	
1S526-12-12	3/4	1-1/16x16	5/8	4.00	102	0.18	4,7	1-1/16	3.06	78	

When measuring overall length to the end of the nut, B+D must be used to calculate cut-off allowance.

See Accessories Section for O-Rings.

1S526-PR

Male Tube-O - Swivel - Short Pilot
with Charge Port for R12

# Part Number	Thread		Hose I.D. inch	A		D		G		W inch	B	
	inch	7/8x18		inch	mm	inch	mm	inch	mm		inch	mm
1S526-10-10-PR	5/8	7/8x18	1/2	3.52	89	0.18	4,7	0.47	12	7/8	2.57	65
1S526-10-12-PR	5/8	7/8x18	5/8	3.68	93	0.18	4,7	0.47	12	7/8	2.74	70

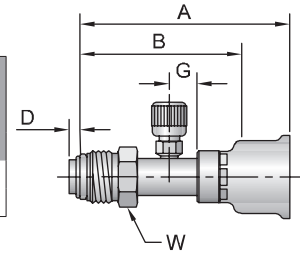

15R26

Male Tube-O - Swivel - 45° Elbow - Short Pilot

# Part Number	Thread		Hose I.D. inch	A		D		E		W inch	B	
	inch	5/8x18		inch	mm	inch	mm	inch	mm		inch	mm
15R26-6-6	3/8	5/8x18	5/16	2.52	64	0.18	4,7	0.85	22	5/8	1.66	42
15R26-8-8	1/2	3/4x18	13/32	2.53	64	0.18	4,7	1.05	27	3/4	1.67	42
15R26-10-10	5/8	7/8x18	1/2	2.99	76	0.18	4,7	1.25	32	7/8	2.04	52
15R26-10-12	5/8	7/8x18	5/8	3.16	80	0.18	4,7	1.25	32	7/8	2.22	56

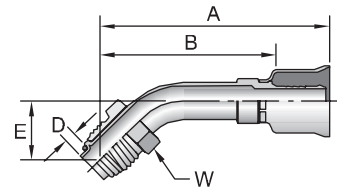

15K26

Male Tube-O - Swivel - 90° Elbow - Short Pilot

# Part Number	Thread		Hose I.D. inch	A		D		E		W inch	B	
	inch	5/8x18		inch	mm	inch	mm	inch	mm		inch	mm
15K26-6-6	3/8	5/8x18	5/16	2.06	52	0.18	4,7	1.76	45	5/8	1.19	30
15K26-7-6	7/16	11/16x16	5/16	2.21	56	0.18	4,7	1.76	44	11/16	1.35	34
15K26-8-8	1/2	3/4x18	13/32	2.06	52	0.18	4,7	1.74	44	3/4	1.20	30
15K26-10-10	5/8	7/8x18	1/2	2.34	59	0.18	4,7	2.20	56	7/8	1.39	35
15K26-10-12	5/8	7/8x18	5/8	2.51	64	0.18	4,7	2.20	56	7/8	1.57	40

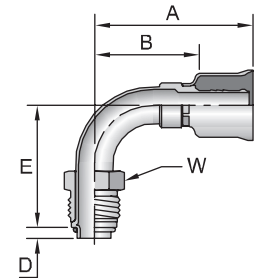

15K26-PB

Male Tube-O - Swivel - 90° Elbow - Short Pilot
with High Pressure Charge Port for R134a

# Part Number	Thread		Hose I.D. inch	A		D		E		G		W inch	B	
	inch	3/4x18 <th>inch</th> <th>mm</th> <th>inch</th> <th>mm</th> <th>inch</th> <th>mm</th> <th>inch</th> <th>mm</th> <th>inch</th> <th>mm</th>		inch	mm	inch	mm	inch	mm	inch	mm		inch	mm
15K26-8-8-PB	1/2	3/4x18	13/32	2.70	69	0.18	4,6	1.74	44	0.60	15	3/4	1.88	48

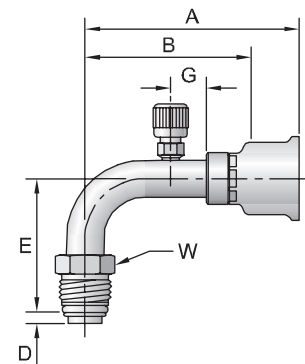

Hose
A

Fittings 26 Series
B

Equipment
C

Accessories
D

Technical
E

Hose
A

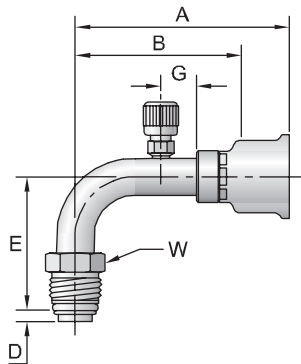

15K26-PR

Male Tube-O - Swivel - 90° Elbow - Short Pilot
with Charge Port for R12

# Part Number	Thread		Hose I.D.	A		D		E		G		W	B	
	inch	mm	inch	inch	mm	inch	mm	inch	mm	inch	mm	inch	inch	mm
15K26-10-10-PR	5/8	7/8x18	1/2	3.14	80	0.18	4,7	2.25	57	0.60	15	7/8	2.19	56
15K26-10-12-PR	5/8	7/8x18	5/8	3.43	87	0.18	4,7	2.22	56	0.60	15	7/8	2.49	63

Fittings 26 Series
B

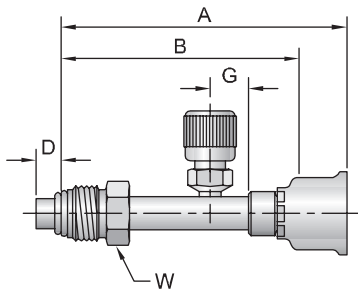

14526-PR

Male Tube-O - Swivel - Long Pilot With
Charge Port for R12

# Part Number	Thread		Hose I.D.	A		D		G		W	B	
	inch	mm	inch	inch	mm	inch	mm	inch	mm	inch	inch	mm
14526-6-6-PR	3/8	5/8x18	5/16	3.25	83	0.28	7,1	0.50	13	5/8	2.40	61

Equipment
C

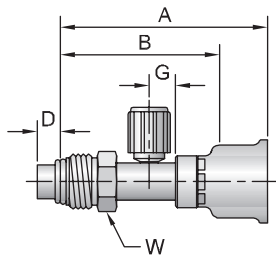

14526-PT

Male Tube-O - Swivel - Long Pilot With
Charge Port for R134a

# Part Number	Thread		Hose I.D.	A		D		G		W	B	
	inch	mm	inch	inch	mm	inch	mm	inch	mm	inch	inch	mm
14526-10-12-PT	5/8	7/8x18	5/8	3.45	88	0.38	9,8	0.44	11	7/8	2.51	64

Accessories
D

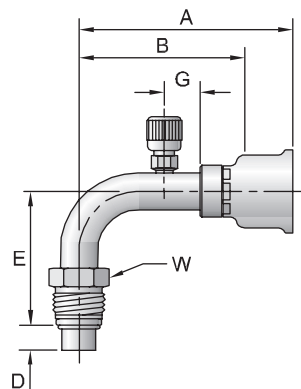

15M26-PR

Male Tube-O - Swivel - 90° Elbow - Long Pilot With
Charge Port for R12

# Part Number	Thread		Hose I.D.	A		D		E		G		W	B	
	inch	mm	inch	inch	mm	inch	mm	inch	mm	inch	mm	inch	inch	mm
15M26-6-6-PR	3/8	5/8x18	5/16	2.48	63	0.28	7,1	1.58	40	0.50	13	5/8	1.62	41

Technical
E

15M26-PT

Male Tube-O - Swivel - 90° Elbow - Long Pilot With Charge Port for R134a

# Part Number	Thread		Hose I.D.		A		D		E		G		W		B	
	inch	mm	inch	mm	inch	mm	inch	mm	inch	mm	inch	mm	inch	mm	inch	mm
15M26-10-12-PT	5/8	7/8x18	5/8	3.25	83	0.38	9,8	2.25	57	0.60	15	7/8	2.31	59		

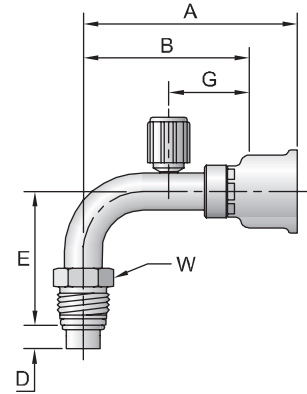

15G26

Male Tube-O - Rigid - Internal Long Pilot (3-Step)

# Part Number	Thread		Hose I.D.		A		H		B	
	inch	mm	inch	mm	inch	mm	inch	mm	inch	mm
15G26-6-6	3/8	5/8x18	3/8	1.78	45	0.625	0.92	23		
15G26-8-8	1/2	3/4x16	13/32	1.95	50	3/4	1.09	28		
15G26-10-10	5/8	7/8x14	1/2	4.05	103	7/8	3.10	79		
15G26-10-12	5/8	7/8x14	5/8	2.19	56	0.875	1.25	32		

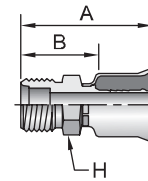

15G26-PR

Male Tube-O - Rigid - Internal Long Pilot (3-Step) With Charge Port for R12

# Part Number	Thread		Hose I.D.		A		G		W		B	
	inch	mm	inch	mm	inch	mm	inch	mm	inch	mm	inch	mm
15G26-10-12-PR	5/8	7/8x14	5/8	4.27	108	0.60	15	7/8	3.33	85		

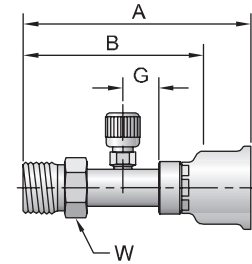

15S26

Female Tube-O - Swivel - Short Pilot

# Part Number	Thread		Hose I.D.		A		D		W		B	
	inch	mm	inch	mm	inch	mm	inch	mm	inch	mm	inch	mm
15S26-6-6	3/8	5/8x18	5/16	2.54	65	0.18	4,7	3/4	1.68	43		
15S26-8-8	1/2	3/4x16	13/32	2.68	68	0.18	4,7	7/8	1.82	46		
15S26-10-10	5/8	7/8x14	1/2	2.84	72	0.18	4,7	1-1/16	1.89	48		
15S26-10-12	5/8	7/8x14	5/8	3.63	92	0.18	4,7	1-1/16	2.69	68		
15S26-12-12	3/4	1-1/16x14	5/8	4.00	102	0.18	4,7	1-1/4	3.06	78		

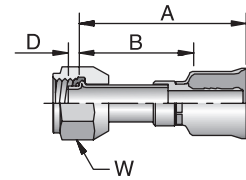

Hose
A

Fittings 26 Series
B

Equipment
C

Accessories
D

Technical
E

Hose
A

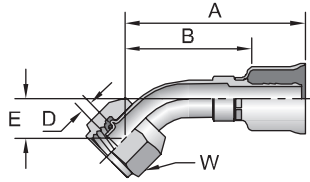

15H26

Female Tube-O - Swivel 45° Elbow - Short Pilot

# Part Number	Thread inch	Hose I.D. inch	A		D		E		W		B	
			inch	mm	inch	mm	inch	mm	inch	inch	mm	mm
15H26-6-6	3/8 5/8x18	5/16	2.35	60	0.18	4,7	0.54	14	3/4	1.49	38	
15H26-8-8	1/2 3/4x16	13/32	2.48	63	0.18	4,7	0.60	15	7/8	1.62	41	
15H26-10-10	5/8 7/8x14	1/2	3.23	82	0.18	4,7	0.67	17	1 1/16	2.28	58	
15H26-10-12	5/8 7/8x14	3/4	3.43	87	0.18	4,7	0.67	17	1-1/16	2.46	62	

Fittings 26 Series
B

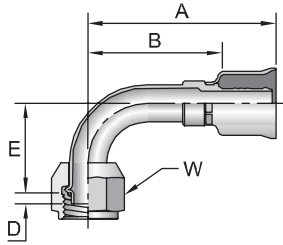

15T26

Female Tube-O - Swivel - 90° Elbow - Short Pilot

# Part Number	Thread inch	Hose I.D. inch	A		D		E		W		B	
			inch	mm	inch	mm	inch	mm	inch	inch	mm	mm
15T26-6-6	3/8 5/8x18	5/16	1.89	48	0.18	4,7	1.15	29	3/4	1.03	26	
15T26-8-8	1/2 3/4x16	13/32	2.34	59	0.18	4,7	1.46	37	7/8	1.48	38	
15T26-10-10	5/8 7/8x14	1/2	2.08	53	0.18	4,7	1.75	44	1-1/16	1.08	27	
15T26-10-12	5/8 7/8x14	5/8	2.20	56	0.18	4,7	1.53	39	1-1/16	1.26	32	
15T26-12-12	3/4 1-1/16x14	5/8	2.63	67	0.18	4,7	1.75	44	1-1/4	1.69	43	

Equipment
C

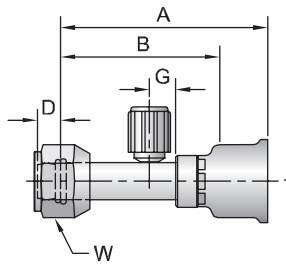

15926-PB

Female Tube-O - Swivel - Long Pilot
With High Pressure Charge Port for R134a

# Part Number	Thread inch	Hose I.D. inch	A		D		G		W		B	
			inch	mm	inch	mm	inch	mm	inch	inch	mm	mm
15926-6-6-PB	3/8 5/8x18	5/16	3.25	83	0.28	7,1	0.75	19	3/4	2.39	61	
15926-8-8-PB	1/2 3/4x16	13/32	2.74	70	0.38	9,8	0.50	13	7/8	1.88	48	

Accessories
D

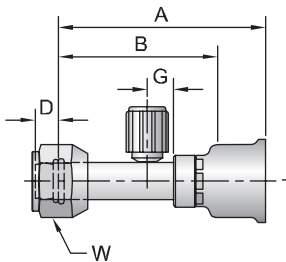

15926-PT

Female Tube-O - Swivel - Long Pilot
With Low Pressure Charge Port for R134a

# Part Number	Thread inch	Hose I.D. inch	A		D		G		W		B	
			inch	mm	inch	mm	inch	mm	inch	inch	mm	mm
15926-10-12-PT	5/8 7/8x14	5/8	3.47	88	0.38	9,8	0.60	15	1-1/16	2.53	64	

Technical
E

15N26-PB

Female Tube-O - Swivel - 45° Elbow - Long Pilot
With High Pressure Charge Port for R134a

# Part Number	Thread		Hose I.D. inch	A		D		E		G	W		B	
	inch	mm		inch	mm	inch	mm	inch	mm		inch	mm	inch	mm
15N26-8-8-PB	1/2	3/4x16	13/32	3.67	93	0.38	9,8	0.90	23	0.60	15	7/8	2.81	72

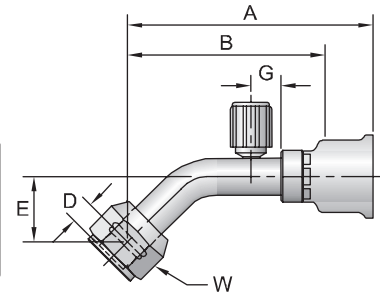

15N26-PT

Female Tube-O - Swivel - 45° Elbow - Long Pilot
With Low Pressure Charge Port for R134a

# Part Number	Thread		Hose I.D. inch	A		D		E		G	W		B	
	inch	mm		inch	mm	inch	mm	inch	mm		inch	mm	inch	mm
15N26-10-12-PT	5/8	7/8x14	5/8	3.92	100	0.38	9,8	1.21	31	0.60	15	1-1/16	2.98	76

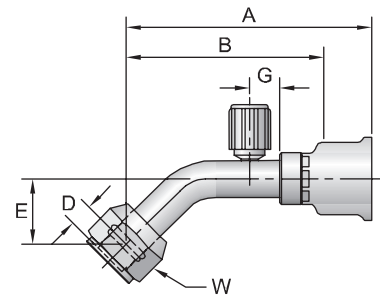

15L26

Female Tube-O - Swivel - 90° Elbow - Long Pilot

# Part Number	Thread		Hose I.D. inch	A		D		E		W	B	
	inch	mm		inch	mm	inch	mm	inch	mm		inch	mm
15L26-8-8	1/2	3/4x14	13/32	2.14	54	0.38	9,8	1.46	37	7/8	1.28	33

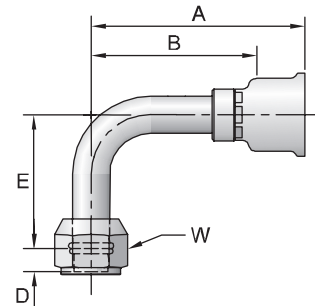

15L26-PB

Female Tube-O - Swivel - 90° Elbow - Long Pilot
With High Pressure Charge Port for R134a

# Part Number	Thread		Hose I.D. inch	A		D		E		G	W		B	
	inch	mm		inch	mm	inch	mm	inch	mm		inch	mm	inch	mm
15L26-6-6-PB	3/8	5/8x18	5/16	2.50	64	0.28	7,1	1.22	31	0.50	13	3/4	1.64	42
15L26-8-8-PB	1/2	3/4x16	13/32	2.80	71	0.38	9,8	1.46	37	0.60	15	7/8	1.94	49
15L26-10-12-PB	5/8	7/8x14	5/8	2.80	71	0.38	9,8	1.46	37	0.60	15	1-1/16	1.94	49

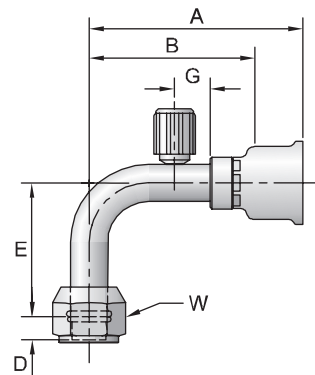

Hose
A

Fittings 26 Series
B

Equipment
C

Accessories
D

Technical
E

Hose
A

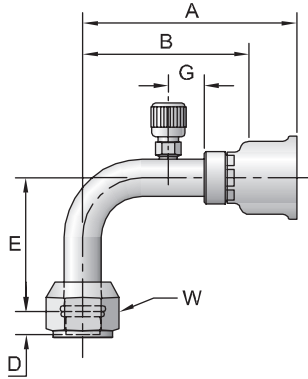

15L26-PR

Female Tube-O - Swivel - 90° Elbow - Long Pilot
With Charge Port for R12

# Part Number	Thread inch	Hose I.D. inch	A		D		E		G		W		B	
			inch	mm	inch	mm	inch	mm	inch	mm	inch	mm	inch	mm
15L26-8-8-PR	1/2 3/4x16	13/32	2.79	71	0.38	9,8	1.46	37	0.60	15	7/8	1.93	49	
15L26-10-10-PR	5/8 7/8x14	1/2	3.59	91	0.38	9,8	2.25	57	0.60	15	1-1/16	2.64	67	
15L26-10-12-PR	5/8 7/8x14	5/8	3.25	83	0.38	9,8	2.25	57	0.60	15	1-1/16	2.31	59	

Fittings 26 Series
B

15L26-PT

Female Tube-O - Swivel - 90° Elbow - Long Pilot
With Low Pressure Charge Port for R134a

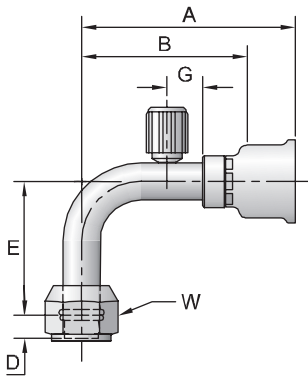

# Part Number	Thread inch	Hose I.D. inch	A		D		E		G		W		B	
			inch	mm	inch	mm	inch	mm	inch	mm	inch	mm	inch	mm
15L26-10-10-PT	5/8 7/8x14	1/2	2.95	75	0.38	9,8	2.25	57	0.60	15	1-1/16	2.00	51	
15L26-10-12-PT	5/8 7/8x14	5/8	3.25	83	0.38	9,8	2.25	57	0.60	15	1-1/16	2.31	59	
15L26-12-12-PT	3/4 1-1/16x14	5/8	3.58	91	0.38	9,8	2.66	68	0.60	15	1-1/4	2.64	67	

Equipment
C

15P26-PT

Male Tube-O - Swivel - 45° Elbow - Long Pilot With
Low Pressure Charge Port for R134a

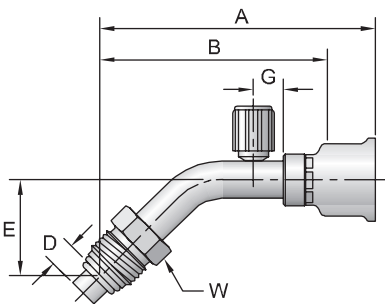

# Part Number	Thread inch	Hose I.D. inch	A		D		E		G		W		B	
			inch	mm	inch	mm	inch	mm	inch	mm	inch	mm	inch	mm
15P26-10-12-PT	5/8 7/8x18	5/8	3.81	97	0.38	9,8	1.21	31	0.60	15	7/8	2.87	73	

Accessories
D

17B26

Female Air Brake Jounce Line - Swivel

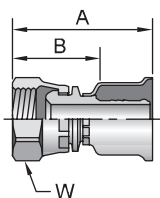

# Part Number	Thread inch	Hose inch	A		W		B	
			inch	mm	inch	mm	inch	mm
17B26-8-6BA	1/2 3/4x20	5/16	1.75	44	11/16	0.89	23	
17B26-8-8BA	1/2 3/4x20	13/32	1.75	44	11/16	0.89	23	

Technical
E

15V26

Female Compressor - Swivel - 45° Elbow

# Part Number	Thread inch	Hose I.D. inch	A		E		W inch	B	
			inch	mm	inch	mm		inch	mm
15V26-12-8	1x14	13/32	2.72	69	0.75	19	1-1/8	1.86	47
15V26-12-12	1x14	5/8	3.39	86	0.76	19	1-1/8	2.45	62

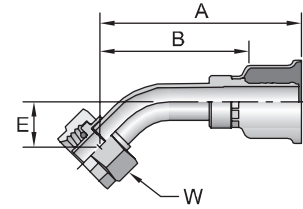

15W26

Female Compressor - Swivel - 90° Elbow

# Part Number	Thread inch	Hose I.D. inch	A		E		W inch	B	
			inch	mm	inch	mm		inch	mm
15W26-12-8	1x14	13/32	2.24	57	1.25	32	1.125	1.38	35
15W26-12-12	1x14	5/8	3.04	77	1.63	41	1.125	2.10	53

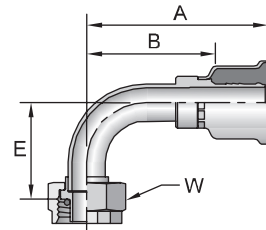

15Z26

Female Compressor - Swivel - 90° Elbow - Block Type

# Part Number	Thread inch	Hose I.D. inch	A		E		W inch	B	
			inch	mm	inch	mm		inch	mm
15Z26-12-8	1X14	0.40625	1.79	45	0.80	20	1.125	0.93	24
15Z26-12-12	1X14	0.625	1.87	47	0.80	20	1.125	0.93	24

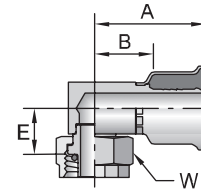

1RV26

Female Compressor - Swivel - 135° Elbow

# Part Number	Hose I.D. inch	inch	A		E		W inch	B	
			inch	mm	inch	mm		inch	mm
1RV26-12-8	13/32	3.24	82	3.21	82	1-1/8	2.38	60	
1RV26-12-12	5/8	2.32	59	3.21	82	1-1/8	1.38	35	

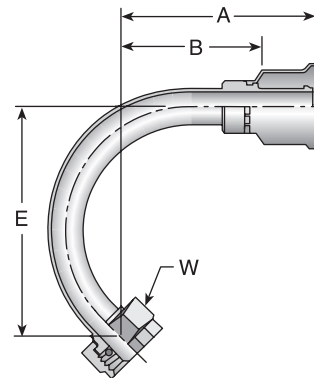

Hose
A

Fittings 26 Series
B

Equipment
C

Accessories
D

Technical
E

Hose
A

Fittings 26 Series
D

Equipment
C

Accessories
D

Technical
M

1RZ26

Female Compressor - Swivel - 180° Elbow - Block Type RZ

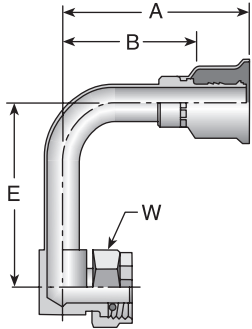

# Part Number	Thread inch	Hose I.D. inch	A		E		W		B	
			inch	mm	inch	mm	inch	inch	mm	
1RZ26-12-12	1x14	5/8	2.98	76	3.13	80	1-1/8	2.04	52	

1T126

Male Refrigerant Tube Mender
(with Nut and Ferrule)

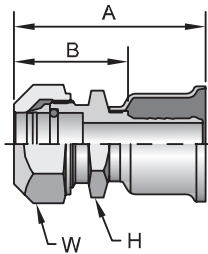

# Part Number	Thread inch		Hose I.D. inch	A		H inch	B	
	inch	mm		inch	mm		inch	mm
1T126-6-6	3/8	5/8x18	5/16	1.96	50	11/16	1.10	28
1T126-8-8	1/2	3/4x16	13/32	2.07	53	13/16	1.21	31
1T126-10-10	5/8	7/8x14	1/2	2.28	58	15/16	1.33	34
1T126-10-12	5/8	7/8x14	5/8	2.27	58	15/16	1.33	34
1T126-12-12	3/4	1-16x14	5/8	2.33	59	1-1/8	1.39	35

1T126 Assembly instructions on page B-25.

1T126

Fitting Installation Instructions

1. Cut the tube off squarely next to the hose fitting. At least 7/8" straight length is required and the outside diameter of the tube should be smooth and free from deep lengthwise scratches.
2. To prevent cutting the inside of the O-Ring, smoothly chamfer the outside diameter of the cut end 15° to 30°. Deburr the inside diameter.
3. Remove the nut, compression sleeve, and O-Ring from the fitting and lubricate the O-Ring with a lubricant that is compatible with the refrigerant used in the system.
4. Place the lubricated O-Ring in the counterbore of the fitting.
5. Slip the compression sleeve, small end, into the nut and assemble the nut on the fitting fingertight. Make sure the compression sleeve is not cocked in the nut. Back the nut off 1/6 to 1/3 turn (one to two hex flats).
6. Insert the chamfered tube end through the nut into the fitting. If high resistance is felt when the end of the tube contacts the O-Ring, remove the tube. The end of the tube may require a large chamfer and/or the O-Ring may require more lubrication on the inside diameter. Repeat the previous steps.
7. (a) Make sure the tube is bottomed in the fitting
(b) Tighten the nut finger tight
(c) Mark the fitting and nut hex indicating the starting point (see illustration) and
(d) Wrench tighten the nut 1 to 1-1/6 turns (6 to 7 hex flats).
8. Later, if it is ever necessary to loosen the connection, re-assemble the nut 1/6 turn (one hex flat) after finger tight.

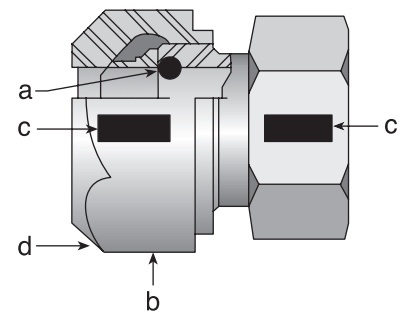

IF YOU HAVE QUESTIONS CONCERNING THE PRODUCTS
OR APPLICATION OF THE PRODUCTS CONTAINED IN THIS
CATALOG, PLEASE CALL:

PARKER HOSE PRODUCTS DIVISION
TECHNICAL SERVICES DEPARTMENT
PHONE: 440 / 943-5700
FAX: 440 / 943-3129
<http://www.parkerhose.com>

Hose
A

Fittings 26 Series
B

Equipment
C

Accessories
D

Technical
E

NPTF Pipe	10143 B-29	11343 B-29	11L43 B-30	10243 B-30	1S243 B-31
	Male - Rigid	Male - Swivel	Male - Swivel 90° Elbow	Female - Rigid	Female - Swivel
NPSM Pipe	10743 B-30	Straight Thread O-Ring	10543 B-31	10G43 B-31	10L43 B-32
	Female - Swivel		Male - Rigid	Male - Swivel	Male - Swivel 90° Elbow
JIC 37°	10343 B-32	11B43 B-33	10643 B-33	13743 B-34	1L743 B-34
	Male - Rigid	Male - Bulkhead	Female - Swivel	Female - Swivel 45° Elbow - Short	Female - Swivel 45° Elbow - Medium
13943 B-35	1L943 B-35	14143 B-36	14V43 B-36	SAE 45°	10443 B-36
Female - Swivel 90° Elbow - Short	Female - Swivel 90° Elbow - Medium	Female - Swivel 90° Elbow - Long	Female - Swivel 150° Elbow		Male - Rigid
10843 B-36	17743 B-37	17943 B-37	Flareless	11143 B-37	11243 B-38
Female - Swivel	Female - Swivel 45° Elbow	Female - Swivel 90° Elbow		Male - Rigid	Female - Swivel
1GJ43 B-38	Inverted Flare	12843 B-38	16743 B-39	16943 B-39	Code 61 Flange
Female - Rigid		Male - Swivel	Male - Swivel 45° Elbow	Male - Swivel 90° Elbow	
11543 B-39	11643 B-40	12643 B-40	11743 B-40	12743 B-41	11843 B-41
Flange Head	22-1/2° Elbow	30° Elbow	45° Elbow	60° Elbow	67-1/2° Elbow
11943 B-41	Seal-Lok® (O-Ring Face Seal)	1J043 B-42	1JB43 B-42	1JC43 B-43	1JS43 B-44
90° Elbow		Male - Rigid w/O-Ring	Male - Bulkhead w/O-Ring	Female - Swivel Short	Female - Swivel Long

Hose
A

Fittings 43 Series
B

Equipment
C

Accessories
D

Technical
E











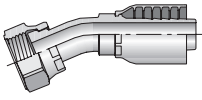
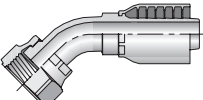
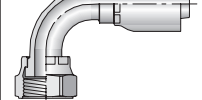
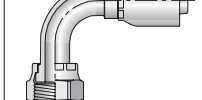

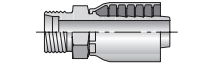
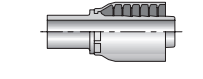
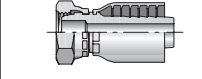
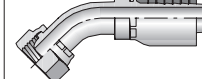

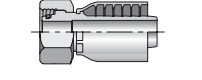



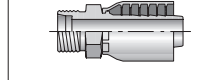
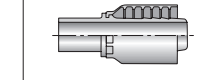
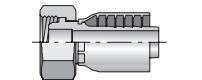

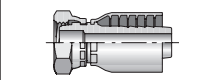

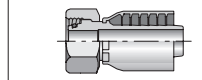

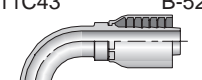

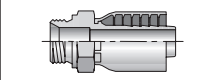
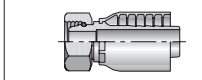
Hose
A

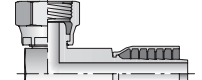
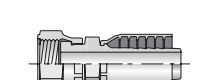
Fittings 43 Series
B

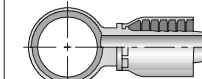
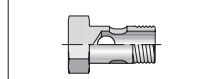
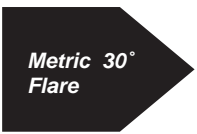
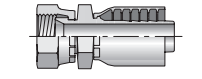
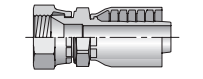
Equipment
C

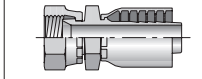
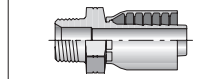
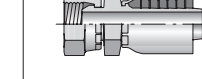
Accessories
D

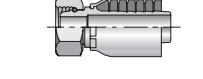
Technical
E

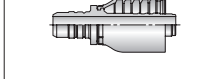
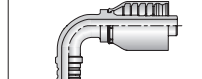
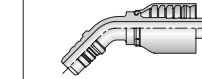
1J643  Female - Swivel 22-1/2° Elbow	B-44	1J743  Female - Swivel 45° Elbow	B-45	1J943  Female - Swivel 90° Elbow - Short	B-46	1J543  Female - Swivel 90° Elbow - Medium	B-46	1J143  Female - Swivel 90° Elbow - Long	B-47	 DIN "L" Series	
1D043  Male - Rigid	B-47	11D43  Male Standpipe Rigid	B-47	1C343  Female - Swivel	B-48	1C443  Female - Swivel 45° Elbow	B-48	1C543  Female - Swivel 90° Elbow	B-48	 DIN "L" Series w/O-Ring	
1CA43  Female - Swivel	B-49	1CE43  Female - Swivel 45° Elbow	B-49	1CF43  Female - Swivel 90° Elbow	B-49	 DIN "S" Series		1D243  Male - Rigid	B-50	13D43  Male Standpipe Rigid	B-50
1C643  Female - Swivel	B-50	 DIN 60° Cone		1C043  Female - Swivel	B-51	 DIN "S" Series w/O-Ring		1C943  Female - Swivel	B-51	10C43  Female - Swivel 45° Elbow	B-51
11C43  Female - Swivel 90° Elbow	B-52	 BSP		1D943  Male - Rigid	B-52	19243  Female - Swivel	B-52	1B143  Female - Swivel 45° Elbow	B-53	1B243  Female - Swivel 90° Elbow	B-53
1B443  Female - Swivel 90° Elbow - Block Type	B-53	1B543  Female - Swivel Flat Seat	B-54	 Banjo		14943  Metric Banjo	B-54	AM  Bolt	B-54	 Metric 30° Flare	
1MU43  Female - Swivel	B-55	1XU43  Female - Swivel	B-55	 BSP		1FU43  Female - Swivel	B-56	1UT43  Male - Rigid	B-56	1GU43  Female - Swivel	B-56
 French Gaz		1F443  Female - Swivel	B-56	 UPTC		1EN43  Male	B-58	1ET43  Male 90° Elbow	B-58	1EU43  Male 45° Elbow	B-58

10143

Male NPTF Pipe - Rigid

# Part Number	Thread inch	Hose I.D. inch	A		H inch	B		Additional Material Stainless Steel (C)
			inch	mm		inch	mm	
10143-2-4	1/8x27	1/4	1.80	46	9/16	1.05	27	
10143-4-4	1/4x18	1/4	2.01	51	9/16	1.26	32	•
10143-4-5	1/4x18	5/16	1.94	49	11/16	1.19	30	
10143-4-6	1/4x18	3/8	2.28	58	3/4	1.25	32	
10143-6-4	3/8x18	1/4	1.86	47	11/16	1.11	28	
10143-6-5	3/8x18	5/16	1.94	49	11/16	1.19	30	
10143-6-6	3/8x18	3/8	2.37	60	3/4	1.34	34	•
10143-6-8	3/8x18	1/2	2.59	66	7/8	1.33	34	
10143-6-10	3/8x18	5/8	2.61	66	15/16	1.17	30	
10143-8-4	1/2x14	1/4	2.13	54	7/8	1.38	35	
10143-8-6	1/2x14	3/8	2.39	61	7/8	1.36	35	
10143-8-8	1/2x14	1/2	2.84	72	7/8	1.58	40	•
10143-8-10	1/2x14	5/8	3.04	77	15/16	1.59	40	
10143-8-12	1/2x14	3/4	3.04	77	1-1/16	1.60	41	
10143-12-8	3/4x14	1/2	2.68	68	1-1/16	1.42	36	
10143-12-10	3/4x14	5/8	2.87	73	1-1/16	1.43	36	
10143-12-12	3/4x14	3/4	3.09	78	1-1/16	1.65	42	•
10143-12-16	3/4x14	1	3.40	86	1-3/8	1.78	45	
10143-16-12	1x11-1/2	3/4	3.09	78	1-3/8	1.65	42	
10143-16-16	1x11-1/2	1	2.59	66	1-3/8	1.97	50	•
10143-20-20	1-1/4x11-1/2	1-1/4	4.08	104	1-3/4	2.39	61	•
10143-24-24	1-1/2x11-1/2	1-1/2	3.50	89	2	2.13	54	
10143-32-32	2x11-1/2	2	4.05	103	2-1/2	2.27	58	

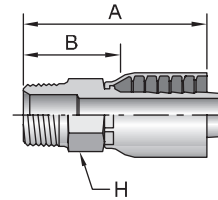

Stainless steel fittings must be assembled with Karrykrimp 2, PHastkrimp, Superkrimp or Parkrimp 2. See CrimpSource for more information.

11343

Male NPTF Pipe - Swivel

# Part Number	Thread inch	Hose I.D. inch	A		W inch	B	
			inch	mm		inch	mm
11343-2-4	1/8x27	1/4	2.94	75	5/8	2.19	56
11343-4-4	1/4x18	1/4	2.68	68	5/8	1.93	49
11343-4-6	1/4x18	3/8	3.01	76	5/8	1.98	50
11343-6-4	3/8x18	1/4	2.81	71	3/4	2.06	52
11343-6-6	3/8x18	3/8	3.08	78	3/4	2.05	52
11343-6-8	3/8x18	1/2	3.30	84	3/4	2.04	52
11343-8-6	1/2x14	3/8	3.30	84	7/8	2.27	58
11343-8-8	1/2x14	1/2	3.52	89	7/8	2.26	57
11343-12-12	3/4x14	3/4	3.93	100	1-1/4	2.49	63
11343-16-16	1x11-1/2	1	4.52	115	1-1/2	2.90	74

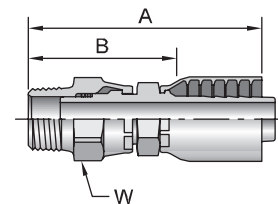

O-Ring not compatible with Phosphate Ester fluids.

Fitting allows minor movement under pressure to relieve stress on hose but is not to be used on continuous or extensive swiveling.

Hose
A

Fittings 43 Series
B

Equipment
C

Accessories
D

Technical
E

Hose
A

Fittings 43 Series
B

Equipment
C

Accessories
D

Technical
E

11L43

Male NPTF Pipe - Swivel - 90° Elbow

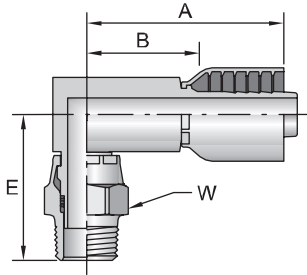

# Part Number	Thread inch	Hose I.D. inch	A		E		W		B	
			inch	mm	inch	mm	inch	mm	inch	mm
11L43-4-4	1/4x18	1/4	2.23	57	1.79	45	5/8	1.48	38	
11L43-4-6	1/4x18	3/8	2.53	64	1.85	47	5/8	1.50	38	
11L43-6-6	3/8x18	3/8	2.53	64	1.94	49	3/4	1.50	38	
11L43-8-6	1/2x14	3/8	2.66	68	2.17	55	7/8	1.63	41	
11L43-8-8	1/2x14	1/2	2.96	75	2.17	55	7/8	1.70	43	
11L43-12-12	3/4x14	3/4	3.32	84	2.46	62	1-1/4	1.88	48	

O-Ring not compatible with Phosphate Ester fluids.

Fitting allows minor movement under pressure to relieve stress on hose but is not to be used on continuous or extensive swiveling.

10243

Female NPTF Pipe - Rigid

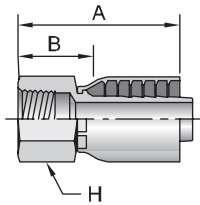

# Part Number	Thread inch	Hose I.D. inch	A		H		B	
			inch	mm	inch	mm	inch	mm
10243-2-4	1/8x27	1/4	1.68	43	5/8	0.93	24	
10243-4-4	1/4x18	1/4	1.78	45	11/16	1.03	26	
10243-4-6	1/4x18	3/8	2.05	52	3/4	1.02	26	
10243-6-4	3/8x18	1/4	2.05	52	7/8	1.30	33	
10243-6-6	3/8x18	3/8	2.32	59	7/8	1.29	33	
10243-8-6	1/2x14	3/8	2.40	61	1-1/8	1.37	35	
10243-8-8	1/2x14	1/2	2.62	67	1-1/8	1.36	35	
10243-12-12	3/4x14	3/4	2.72	69	1-1/4	1.28	33	

10743

Female NPSM Pipe - Swivel - (60° Cone)

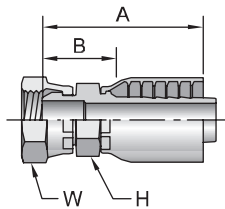

# Part Number	Thread inch	Hose I.D. inch	A		H		W		B	
			inch	mm	inch	inch	inch	mm	inch	mm
10743-2-4	1/8x27	1/4	1.69	43	9/16	9/16	0.94	24		
10743-4-4	1/4x18	1/4	1.74	44	9/16	11/16	0.99	25		
10743-6-6	3/8x18	3/8	2.09	53	11/16	7/8	1.06	27		
10743-8-8	1/2x14	1/2	2.32	59	15/16	1	1.06	27		
10743-12-12	3/4x14	3/4	2.70	69	1-1/16	1-1/4	1.47	37		
10743-16-16	1x11-1/2	1	3.09	78	1-3/8	1-1/2	1.47	37		
10743-20-20	1-1/4x11-1/2	1-1/4	3.28	83	1-7/8	1-7/8	1.59	40		

1S243

Female NPTF Pipe - Swivel

# Part Number	Thread		Hose I.D. inch	A		W inch	B	
	inch			inch	mm		inch	mm
1S243-4-4	1/4	x18	1/4	3.33	85	3/4	2.58	66

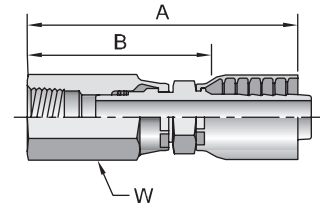

10543

Male SAE Straight Thread with O-Ring - Rigid

# Part Number	Thread		Hose I.D. inch	A		H inch	B	
	inch			inch	mm		inch	mm
10543-4-4	1/4	7/16x20	1/4	1.64	42	9/16	0.89	23
10543-5-4	5/16	1/2x20	1/4	1.80	46	5/8	1.05	27
10543-6-4	3/8	9/16x18	1/4	1.67	42	11/16	0.92	23
10543-6-6	3/8	9/16x18	3/8	2.10	53	11/16	1.07	27
10543-6-8	3/8	9/16x18	1/2	2.32	59	13/16	1.06	27
10543-8-6	1/2	3/4x16	3/8	2.11	54	7/8	1.08	27
10543-8-8	1/2	3/4x16	1/2	2.46	62	7/8	1.20	30
10543-10-6	5/8	7/8x14	3/8	2.13	54	1	1.10	28
10543-10-8	5/8	7/8x14	1/2	2.35	60	1	1.09	28
10543-10-10	5/8	7/8x14	5/8	2.77	70	1	1.33	34
10543-12-8	3/4	1-1/16x12	1/2	2.61	66	1-1/4	1.35	34
10543-12-10	3/4	1-1/16x12	5/8	2.80	71	1-1/4	1.36	35
10543-12-12	3/4	1-1/16x12	3/4	2.81	71	1-1/4	1.37	35
10543-16-12	1	1-5/16x12	3/4	2.81	71	1-1/2	1.37	35
10543-16-16	1	1-5/16x12	1	3.37	86	1-1/2	1.75	44
10543-20-20	1-1/4	1-5/8x12	1-1/4	3.69	94	1-7/8	2.00	51

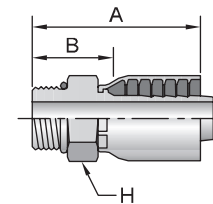

10G43

Male SAE Straight Thread with O-Ring - Swivel

# Part Number	Thread		Hose I.D. inch	A		W inch	B	
	inch			inch	mm		inch	mm
10G43-5-4	5/16	1/2x20	1/4	2.98	76	3/4	2.23	57
10G43-6-4	3/8	9/16x18	1/4	2.98	76	3/4	2.23	57
10G43-6-6	3/8	9/16x18	3/8	3.25	83	3/4	2.22	56
10G43-8-6	1/2	3/4x16	3/8	3.06	78	7/8	2.06	52
10G43-8-8	1/2	3/4x16	1/2	3.21	82	7/8	1.95	50
10G43-10-6	5/8	7/8x14	3/8	3.01	76	1	2.01	51
10G43-10-8	5/8	7/8x14	1/2	3.27	83	1	2.01	51
10G43-12-12	3/4	1-1/16x12	3/4	3.78	96	1-1/4	2.34	59

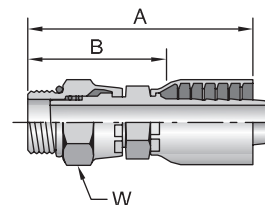

O-Ring not compatible with Phosphate Ester fluids.

Fitting allows minor movement under pressure to relieve stress on hose but is not to be used on continuous or extensive swiveling.

Hose
A

Fittings 43 Series
B

Equipment
C

Accessories
D

Technical
E

10L43

Male SAE Straight Thread with O-Ring - Swivel - 90° Elbow

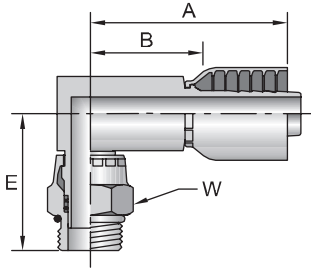

# Part Number	Thread		Hose I.D. inch	A		E		W inch	B	
	inch	mm		inch	mm	inch	mm		inch	mm
10L43-6-6	3/8	9/16x18	3/8	2.53	64	2.10	53	3/4	1.50	38
10L43-8-6	1/2	3/4x16	3/8	2.66	68	1.86	47	7/8	1.63	41
10L43-8-8	1/2	3/4x16	1/2	2.96	75	1.87	47	7/8	1.70	43
10L43-10-8	5/8	7/8x14	1/2	2.96	75	1.92	49	1	1.70	43
10L43-12-12	3/4	1-1/16x12	3/4	3.22	82	2.30	58	1-1/4	1.88	48

O-Ring not compatible with Phosphate Ester fluids.

See Technical Section for pressure limitations.

Fitting allows minor movement under pressure to relieve stress on hose but is not to be used on continuous or extensive swiveling.

10343

Male JIC 37° - Rigid

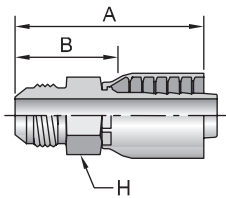

# Part Number	Thread		Hose I.D. inch	A		H inch	B	
	inch	mm		inch	mm		inch	mm
10343-4-4	1/4	7/16x20	1/4	1.99	51	9/16	1.24	31
10343-5-4	5/16	1/2x20	1/4	1.83	46	9/16	1.08	27
10343-5-6	5/16	1/2x20	3/8	2.26	57	3/4	1.23	31
10343-6-4	3/8	9/16x18	1/4	1.84	47	11/16	1.09	28
10343-6-6	3/8	9/16x18	3/8	2.36	60	3/4	1.33	34
10343-8-6	1/2	3/4x16	3/8	2.30	58	7/8	1.27	32
10343-8-8	1/2	3/4x16	1/2	2.68	68	7/8	1.42	36
10343-8-10	1/2	3/4x16	5/8	2.85	72	7/8	1.41	36
10343-10-6	5/8	7/8x14	3/8	2.40	61	15/16	1.37	35
10343-10-8	5/8	7/8x14	1/2	2.62	67	15/16	1.36	35
10343-10-10	5/8	7/8x14	5/8	3.03	77	15/16	1.59	40
10343-12-8	3/4	1-1/16x12	1/2	2.76	70	1-1/8	1.50	38
10343-12-10	3/4	1-1/16x12	5/8	3.07	78	1-1/8	1.63	41
10343-12-12	3/4	1-1/16x12	3/4	3.19	81	1-1/8	1.75	44
10343-14-12	7/8	1-3/16x12	3/4	3.11	79	1-1/4	1.67	42
10343-16-12	1	1-5/16x12	3/4	3.04	77	1-3/8	1.60	41
10343-16-16	1	1-5/16x12	1	3.63	92	1-3/8	2.01	51
10343-20-20	1-1/4	1-5/8x12	1-1/4	3.96	101	1-7/8	2.27	58
10343-24-20^	1-1/2	1-7/8x12	1-1/4	3.71	94	2	2.02	51

^Must be assembled with Die Part No. 83C-A20H in a Superkrimp or Parkrimp 2.

1LB43

Male JIC 37° - Bulkhead without Locknut

# Part Number	Thread		Hose I.D. inch	A		H inch	B	
	inch	mm		inch	mm		inch	mm
1LB43-4-4	1/4	7/16x20	1/4	2.64	67	9/16	1.89	48
1LB43-6-6	3/8	9/16x18	3/8	3.08	78	3/4	2.05	52
1LB43-8-8	1/2	3/4x16	1/2	3.46	88	7/8	2.20	56
1LB43-10-10	5/8	7/8x14	5/8	3.85	98	15/16	2.41	61
1LB43-12-12	3/4	1-1/16x12	3/4	4.08	104	1-1/8	2.64	67

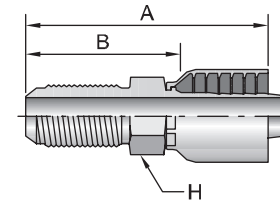

Fittings are stocked less locknut (part no. WLN). Locknuts are manufactured by the Parker Tube Fittings Division and must be ordered separately.

10643

Female JIC 37° - Swivel

# Part Number	Thread		Hose I.D. inch	A		H inch	W inch	B		Additional Material Stainless Steel (C)
	inch	mm		inch	mm			inch	mm	
10643-4-4	1/4	7/16x20	1/4	1.94	49	9/16	9/16	1.19	30	•
10643-4-6	1/4	7/16x20	3/8	2.20	56	11/16	9/16	1.17	30	
10643-5-4	5/16	1/2x20	1/4	2.03	52	9/16	5/8	1.28	33	
10643-5-5	5/16	1/2x20	5/16	2.08	53	11/16	5/8	1.33	34	
10643-5-6	5/16	1/2x20	3/8	2.26	57	11/16	5/8	1.23	31	
10643-6-4	3/8	9/16x18	1/4	2.05	52	9/16	11/16	1.30	33	
10643-6-5	3/8	9/16x18	5/16	2.10	53	11/16	11/16	1.35	34	
10643-6-6	3/8	9/16x18	3/8	2.29	58	11/16	11/16	1.26	32	•
10643-6-8	3/8	9/16x18	1/2	2.51	64	13/16	11/16	1.25	32	
10643-8-6	1/2	3/4x16	3/8	2.49	63	11/16	7/8	1.46	37	•
10643-8-8	1/2	3/4x16	1/2	2.63	67	13/16	7/8	1.37	35	•
10643-8-10	1/2	3/4x16	5/8	2.82	72	15/16	7/8	1.38	35	
10643-8-12	1/2	3/4x16	3/4	2.83	72	1-1/16	7/8	1.39	35	
10643-10-6	5/8	7/8x14	3/8	2.51	64	7/8	1	1.48	38	
10643-10-8	5/8	7/8x14	1/2	2.85	72	7/8	1	1.59	40	
10643-10-10	5/8	7/8x14	5/8	2.93	74	15/16	1	1.49	38	•
10643-10-12	5/8	7/8x14	3/4	2.93	74	1-1/16	1	1.49	38	
10643-12-8	3/4	1-1/16x12	1/2	2.78	71	1-1/16	1-1/4	1.52	39	
10643-12-10	3/4	1-1/16x12	5/8	3.10	79	1-1/16	1-1/4	1.66	42	
10643-12-12	3/4	1-1/16x12	3/4	3.17	81	1-1/16	1-1/4	1.73	44	•
10643-12-16	3/4	1-1/16x12	1	3.29	84	1-3/8	1-1/4	1.67	42	
10643-14-12	7/8	1-3/16x12	3/4	3.18	81	1-1/4	1-3/8	1.74	44	
10643-16-12	1	1-5/16x12	3/4	3.31	84	1-1/4	1-1/2	1.87	47	
10643-16-16	1	1-5/16x12	1	3.62	92	1-3/8	1-1/2	2.00	51	•
10643-20-16	1-1/4	1-5/8x12	1	3.81	97	1-5/8	2	2.19	56	
10643-20-20	1-1/4	1-5/8x12	1-1/4	3.94	100	1-7/8	2	2.25	57	•
10643-24-24	1-1/2	1-7/8x12	1-1/2	3.84	98	2-1/8	2-1/4	2.47	63	
10643-32-32	2	2-1/2x12	2	4.73	120	2-1/2	2-7/8	2.95	75	

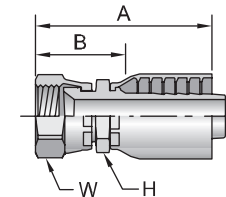

Stainless steel fittings must be assembled with Karrykrimp 2, PHastkrimp, Superkrimp or Parkrimp 2. See CrimpSource for more information.

Hose
A

Fittings 43 Series
B

Equipment
C

Accessories
D

Technical
E

Hose
A

Fittings 43 Series
B

Equipment
C

Accessories
D

Technical
E

13743

Female JIC 37° - Swivel - 45° Elbow - Short Drop

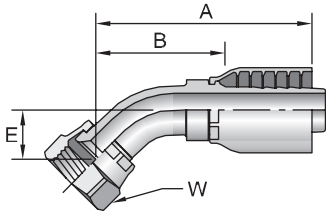

# Part Number	Thread		Hose I.D. inch	A		E		W		B	
	inch	inch		inch	mm	inch	mm	inch	inch	mm	
13743-4-4	1/4	7/16x20	1/4	1.96	50	0.39	10	9/16	1.21	31	
13743-5-4	5/16	1/2x20	1/4	2.19	56	0.39	10	5/8	1.44	37	
13743-6-4	3/8	9/16x18	1/4	2.23	57	0.39	10	11/16	1.48	38	
13743-6-6	3/8	9/16x18	3/8	2.39	61	0.39	10	11/16	1.39	35	
13743-8-6	1/2	3/4x16	3/8	2.74	70	0.55	14	7/8	1.74	44	
13743-8-8	1/2	3/4x16	1/2	2.83	72	0.55	14	7/8	1.57	40	
13743-10-8	5/8	7/8x14	1/2	2.93	74	0.63	16	1	1.67	42	
13743-10-10	5/8	7/8x14	5/8	3.17	81	0.63	16	1	1.73	44	
13743-12-10	3/4	1-1/16x12	5/8	3.62	92	0.83	21	1-1/4	2.08	53	
13743-12-12	3/4	1-1/16x12	3/4	3.63	92	0.78	20	1-1/4	2.19	56	
13743-16-16	1	1-5/16x12	1	4.34	110	0.95	24	1-1/2	2.72	69	
13743-20-20	1-1/4	1-5/8x12	1-1/4	4.59	117	1.19	30	2	2.82	72	
13743-24-24	1-1/2	1-7/8x12	1-1/2	5.50	140	1.47	37	2-1/4	4.18	106	

1L743

Female JIC 37° - Swivel - 45° Elbow - Medium Drop

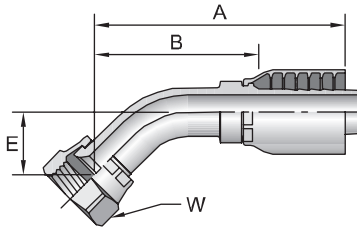

# Part Number	Thread		Hose I.D. inch	A		E		W		B	
	inch	inch		inch	mm	inch	mm	inch	inch	mm	
1L743-6-6	3/8	9/16x18	3/8	2.66	62	0.59	15	11/16	1.63	41	
1L743-8-8	1/2	3/4x16	1/2	3.17	80	0.72	18	7/8	1.91	49	
1L743-12-12	3/4	1-1/16x12	3/4	4.23	107	1.06	27	1-1/4	2.79	71	
1L743-16-16	1	1-5/16x12	1	4.51	115	1.07	27	1-1/2	2.89	73	

13943

Female JIC 37° - Swivel - 90° Elbow - Short Drop

# Part Number	Thread		Hose I.D. inch	A		E		W inch	B	
	inch	inch		inch	mm	inch	mm		inch	mm
13943-4-4	1/4	7/16x20	1/4	1.78	45	0.83	21	9/16	1.03	26
13943-4-6	1/4	7/16x20	3/8	2.11	54	0.83	21	9/16	1.08	27
13943-5-4	5/16	1/2x20	1/4	1.88	48	0.83	21	5/8	1.13	29
13943-5-5	5/16	1/2x20	5/16	1.96	50	0.83	21	5/8	1.21	31
13943-6-4	3/8	9/16x18	1/4	2.12	54	0.85	22	11/16	1.37	35
13943-6-6	3/8	9/16x18	3/8	2.21	56	0.91	23	11/16	1.18	30
13943-6-8	3/8	9/16x18	1/2	2.51	64	0.85	22	11/16	1.25	32
13943-8-6	1/2	3/4x16	3/8	2.52	64	1.09	28	7/8	1.49	38
13943-8-8	1/2	3/4x16	1/2	2.62	67	1.14	29	7/8	1.36	35
13943-10-8	5/8	7/8x14	1/2	2.74	70	1.26	32	1	1.48	38
13943-10-10	5/8	7/8x14	5/8	2.97	75	1.26	32	1	1.69	39
13943-12-8	3/4	1-1/16x12	1/2	3.25	83	1.83	46	1-1/4	1.99	51
13943-12-10	3/4	1-1/16x12	5/8	3.07	78	1.89	48	1-1/4	1.63	41
13943-12-12	3/4	1-1/16x12	3/4	3.49	89	1.89	48	1-1/4	2.05	52
13943-16-12	1	1-5/16x12	3/4	3.49	89	2.00	51	1-1/2	2.05	52
13943-16-16	1	1-5/16x12	1	4.28	109	2.20	56	1-1/2	2.66	68
13943-20-20	1-1/4	1-5/8x12	1-1/4	4.43	113	2.59	66	2	2.74	70
13943-24-24	1-1/2	1-7/8x12	1-1/2	5.50	140	3.81	81	2-1/4	4.13	105

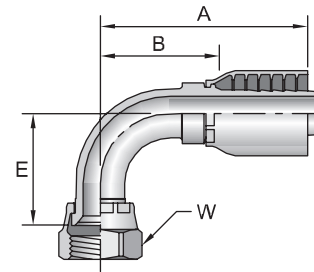

1L943

Female JIC 37° - Swivel - 90° Elbow - Medium Drop

# Part Number	Thread		Hose I.D. inch	A		E		W inch	B	
	inch	inch		inch	mm	inch	mm		inch	mm
1L943-4-4	1/4	7/16x20	1/4	1.84	47	1.26	32	9/16	1.09	28
1L943-6-4	3/8	9/16x18	1/4	2.12	54	1.50	38	11/16	1.37	35
1L943-6-6	3/8	9/16x18	3/8	2.29	58	1.50	38	11/16	1.26	32
1L943-8-6	1/2	3/4x16	3/8	2.51	64	1.61	41	7/8	1.48	38
1L943-8-8	1/2	3/4x16	1/2	2.64	67	1.61	41	7/8	1.38	35
1L943-10-8	5/8	7/8x14	1/2	3.25	83	1.75	44	1	1.99	51
1L943-12-12	3/4	1-1/16x12	3/4	3.49	89	2.28	58	1-1/4	2.05	52
1L943-16-16	1	1-5/16x12	1	4.44	113	2.50	64	1-1/2	2.82	72

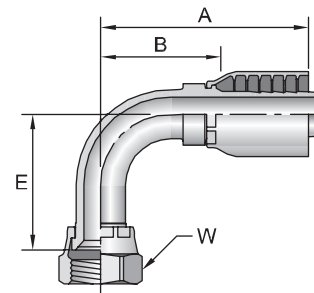

Hose
A

Fittings 43 Series
B

Equipment
C

Accessories
D

Technical
E

Hose
A

Fittings 43 Series
B

Equipment
C

Accessories
D

Technical
E

14143

Female JIC 37° - Swivel - 90° Elbow - Long Drop

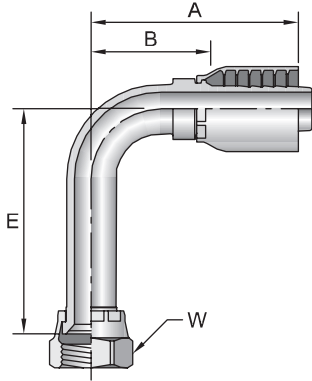

# Part Number	Thread inch		Hose I.D. inch	A inch mm		E inch mm		W inch mm		B inch mm	
14143-4-4	1/4	7/16x20	1/4	1.96	50	1.81	46	9/16	1.21	31	
14143-5-4	5/16	1/2x20	1/4	1.93	49	1.80	46	5/8	1.18	30	
14143-6-6	3/8	9/16x18	3/8	2.27	58	2.18	55	11/16	1.27	32	
14143-8-6	1/2	3/4x16	3/8	2.56	65	2.43	62	7/8	1.56	40	
14143-8-8	1/2	3/4x16	1/2	2.62	67	2.52	64	7/8	1.36	35	
14143-10-8	5/8	7/8x14	1/2	2.78	71	2.58	66	1	1.52	39	
14143-10-10	5/8	7/8x14	5/8	3.16	80	2.58	66	1	1.75	44	
14143-12-12	3/4	1-1/16x12	3/4	3.49	89	3.74	95	1-1/4	2.05	52	
14143-14-12	7/8	1-3/16x12	3/4	3.38	86	3.93	100	1-3/8	1.95	50	
14143-16-16	1	1-5/16x12	1	3.90	99	4.32	110	1-1/2	2.31	59	
14143-20-20	1-1/4	1-5/8x12	1-1/4	4.39	112	5.28	134	2	2.73	69	

14V43

Female JIC 37° - Swivel - 150° Elbow

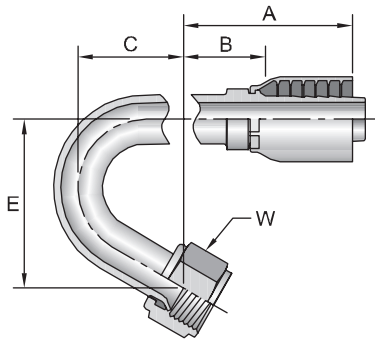

# Part Number	Thread inch		Hose I.D. inch	A inch mm		C inch mm		E inch mm		W inch mm		B inch mm	
14V43-6-4	3/8	9/16x18	1/4	2.89	73	1.36	11/16	1.97	50	11/16	2.16	55	

10443

Male SAE 45° - Rigid

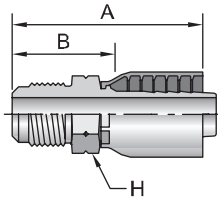

# Part Number	Thread inch		Hose I.D. inch	A inch mm		H inch mm		B inch mm	
10443-6-6	3/8	5/8x18	3/8	2.21	56	3/4	1.21	31	
10443-12-12	3/4	1-1/16x14	3/4	3.20	81	1-1/8	1.77	45	

10843

Female SAE 45° - Swivel

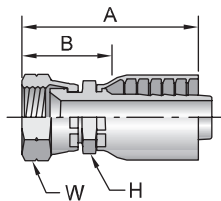

# Part Number	Thread inch		Hose I.D. inch	A inch mm		H inch mm		W inch mm		B inch mm	
10843-6-4	3/8	5/8x18	1/4	2.11	54	3/4	3/4	1.36	35		
10843-6-6	3/8	5/8x18	3/8	2.38	60	3/4	3/4	1.35	34		
10843-12-12	3/4	1-1/16x14	3/4	3.17	81	1-1/16	1-1/4	1.73	44		

Notch on nut signifies SAE 45° flare.

17743

Female SAE 45° - Swivel - 45° Elbow

# Part Number	Thread		Hose I.D. inch	A		E		W inch	B	
	inch	mm		inch	mm	inch	mm		inch	mm
17743-4-6	1/4	7/16x20	3/8	2.28	58	0.33	8	9/16	1.25	32

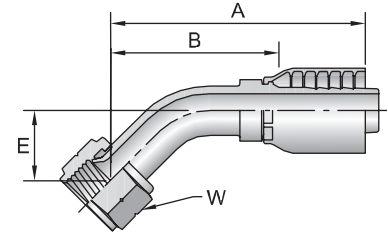

17943

Female SAE 45° - Swivel - 90° Elbow

# Part Number	Thread		Hose I.D. inch	A		E		W inch	B	
	inch	mm		inch	mm	inch	mm		inch	mm
17943-6-6	3/8	5/8x18	3/8	2.13	54	0.85	22	3/4	1.13	29

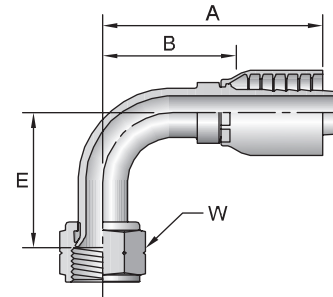

11143

Male Ferulok Flareless - Rigid
(24° Cone with Nut and Ferrule)

# Part Number	Thread		Hose I.D. inch	A		H	W	B	
	inch	mm		inch	mm	inch	inch	inch	mm
11143-4-4	1/4	7/16x20	1/4	2.13	54	9/16	9/16	1.40	36
11143-4-6	1/4	7/16x20	3/8	2.44	62	3/4	9/16	1.44	37
11143-5-4	5/16	1/2x20	1/4	2.13	54	9/16	5/8	1.40	36
11143-5-6	5/16	1/2x20	3/8	2.44	62	3/4	5/8	1.44	37
11143-6-6	3/8	9/16x18	3/8	2.50	64	3/4	11/16	1.50	38
11143-8-8	1/2	3/4x16	1/2	2.93	74	7/8	7/8	1.68	43
11143-10-8	5/8	7/8x14	1/2	3.07	78	15/16	1	1.82	46
11143-12-12	3/4	1-1/16x12	3/4	3.39	86	1-1/8	1-1/4	1.96	50
11143-16-16	1	1-5/16x12	1	3.80	97	1-3/8	1-1/2	2.18	55

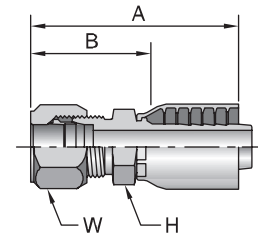

The Parker Ferrul-Fix fitting makes it possible to salvage the bent tube section from a hose assembly for quick, easy on-the-job repairs. For additional information see Ferrule-Fix installation instructions in the Technical Section.

Notch on nut signifies SAE 45° flare.

Hose
A

Fittings 43 Series
B

Equipment
C

Accessories
D

Technical
E

11243

Female Ferulok Flareless - Swivel - (24° Cone)

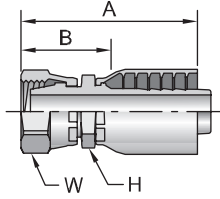

# Part Number	Thread		Hose I.D. inch	A		H inch	W inch	B	
	inch			inch	mm			inch	mm
11243-6-6	3/8	9/16x18	3/8	2.51	64	11/16	11/16	1.48	38
11243-8-6	1/2	3/4x16	3/8	2.67	68	7/8	7/8	1.64	42
11243-8-8	1/2	3/4x16	1/2	2.89	73	7/8	7/8	1.63	41

1GJ43

Female Grease Connection - SPL - PTF Taper Thread Rigid - 1/2 x 27

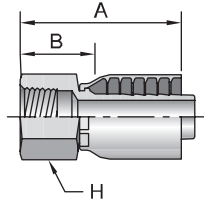

# Part Number	Thread		Hose I.D. inch	A		H inch	B	
	inch			inch	mm		inch	mm
1GJ43-4-4	1/2x27		1/4	1.79	45	3/4	1.04	26
1GJ43-4-6	1/2x27		3/8	2.05	52	3/4	1.02	26

12843

Male Inverted SAE 45° - Swivel

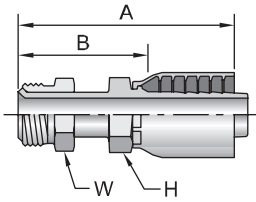

# Part Number	Thread		Hose I.D. inch	A		H inch	W inch	B	
	inch			inch	mm			inch	mm
12843-4-4	1/4	7/16x24	1/4	2.32	59	9/16	7/16	1.57	40
12843-4-6	1/4	7/16x24	3/8	2.65	67	11/16	7/16	1.62	41
12843-5-4	5/16	1/2x20	1/4	2.60	66	9/16	1/2	1.85	47
12843-5-6	5/16	1/2x20	3/8	2.74	70	11/16	1/2	1.71	43
12843-6-6	3/8	5/8x18	3/8	2.86	73	11/16	5/8	1.83	46
12843-7-6	7/16	11/16x18	3/8	2.95	75	11/16	11/16	1.92	49
12843-8-8	1/2	3/4x18	1/2	3.11	79	13/16	3/4	1.85	47
12843-10-10	5/8	7/8x18	5/8	3.55	90	3/4	7/8	2.11	54

16743

Male Inverted SAE 45° - Swivel - 45° Elbow

# Part Number	Thread		Hose I.D. inch	A		E		W inch	B	
	inch	mm		inch	mm	inch	mm		inch	mm
16743-4-4	1/4	7/16x24	1/4	2.09	53	0.63	16	7/16	1.34	34
16743-4-6	1/4	7/16x24	3/8	2.42	61	0.63	16	7/16	1.39	35
16743-5-4	5/16	1/2x20	1/4	2.34	59	0.70	18	1/2	1.59	40
16743-5-6	5/16	1/2x20	3/8	2.48	63	0.70	18	1/2	1.45	37
16743-6-6	3/8	5/8x18	3/8	2.93	74	0.94	24	5/8	1.90	48
16743-8-8	1/2	3/4x18	1/2	3.23	82	1.09	28	3/4	1.97	50

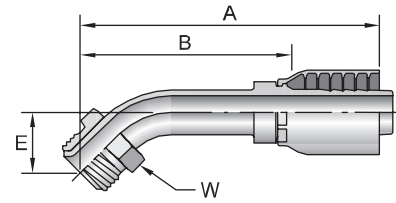

16943

Male Inverted SAE 45° - Swivel - 90° Elbow

# Part Number	Thread		Hose I.D. inch	A		E		W inch	B	
	inch	mm		inch	mm	inch	mm		inch	mm
16943-4-4	1/4	7/16x24	1/4	2.16	55	1.56	40	7/16	1.41	36
16943-4-6	1/4	7/16x24	3/8	2.49	63	1.56	40	7/16	1.46	37
16943-5-4	5/16	1/2x20	1/4	2.41	61	1.65	42	1/2	1.66	42
16943-5-6	5/16	1/2x20	3/8	2.59	66	1.65	42	1/2	1.56	40
16943-6-6	3/8	5/8x18	3/8	2.61	66	1.69	43	5/8	1.58	40
16943-7-6	7/16	11/16x18	3/8	2.53	64	1.72	44	11/16	1.50	38
16943-8-8	1/2	3/4x18	1/2	2.81	71	1.88	48	3/4	1.55	39

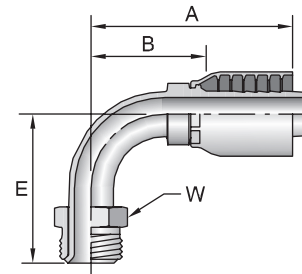

11543

SAE Code 61 Flange Head

ISO 12151-3 - S - L

# Part Number	Flange inch	Hose I.D. inch	A		F inch	B	
			inch	mm		inch	mm
11543-8-8	1/2	1/2	3.48	88	1-3/16	2.22	56
11543-10-10	5/8	5/8	3.78	96,0	1-11/32	2.34	59,4
11543-12-8	3/4	1/2	2.46	62,5	1-1/2	1.20	30,5
11543-12-12	3/4	3/4	3.54	90	1-1/2	2.10	53
11543-16-12	1	3/4	2.74	70	1-3/4	1.30	33
11543-16-16	1	1	4.25	108	1-3/4	2.63	67
11543-20-16	1-1/4	1	3.19	81	2	1.57	40
11543-20-20	1-1/4	1-1/4	4.70	119	2	3.01	76
11543-24-20^^	1-1/2	1-1/4	3.22	82	2-3/8	1.53	39
11543-24-24	1-1/2	1-1/2	4.59	117	2-3/8	3.22	82
11543-24-32	1-1/2	2	5.65	144	2-7/8	3.87	98
11543-32-20^^	2	1-1/4	4.29	109,0	2-13/16	2.60	66,0
11543-32-24	2	1-1/2	3.14	80	2-7/8	1.77	45
11543-32-32	2	2	4.99	127	2-13/16	3.21	82

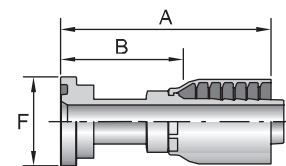

^^Must be assembled with a Superkrimp or Parkrimp 2.
See Accessories Section for O-Rings and Flange Kits.

Hose
A

Fittings 43 Series
B

Equipment
C

Accessories
D

Technical
E

11643

SAE Code 61 Flange Head - 22-1/2° Elbow

ISO 12151-3 - E22M - L

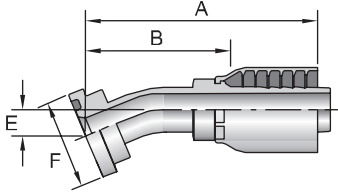

# Part Number	Flange inch	Hose I.D. inch	A		E		F inch	B	
			inch	mm	inch	mm		inch	mm
11643-12-12	3/4	3/4	3.90	99	0.44	11	1-1/2	2.47	63
11643-16-12	1	3/4	3.89	99	0.44	11	1-3/4	2.46	62
11643-16-16	1	1	4.25	108	0.44	11	1-3/4	2.66	68
11643-20-16	1-1/4	1	4.25	108	0.44	11	2	2.66	68
11643-20-20	1-1/4	1-1/4	4.65	118	0.50	13	2	3.00	76
11643-24-20 [^]	1-1/2	1-1/4	4.66	118	0.51	13	2-3/8	3.01	76

12643

SAE Code 61 Flange Head - 30° Elbow

ISO 12151-3 - E30S - L (1 Piece: ISO 12151-3 - E30M - L)

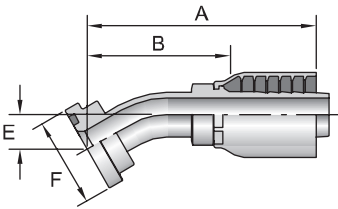

# Part Number	Flange inch	Hose I.D. inch	A		E		F inch	B	
			inch	mm	inch	mm		inch	mm
12643-12-12	3/4	3/4	3.90	99	0.59	15	1-1/2	2.46	62
12643-16-16	1	1	4.38	111	0.62	16	1-3/4	2.76	70
12643-20-16	1-1/4	1	4.38	111	0.62	16	2	2.76	70
12643-20-20	1-1/4	1-1/4	4.39	112	0.72	18	2	2.70	69

11743

SAE Code 61 Flange Head - 45° Elbow

ISO 12151-3 - E45S - L (1 Piece: ISO 12151-3 - E45M - L)

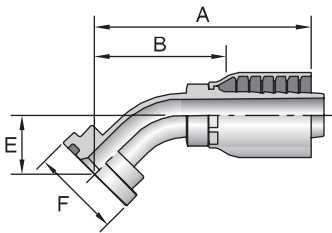

# Part Number	Flange inch	Hose I.D. inch	A		E		F inch	B	
			inch	mm	inch	mm		inch	mm
11743-8-8	1/2	1/2	3.28	83	0.77	20	1-3/16	2.02	51
11743-10-10	5/8	5/8	4.63	118	0.94	24	1-11/32	3.19	81
11743-12-8	3/4	1/2	3.32	84	0.81	21	1-1/2	2.06	52
11743-12-12	3/4	3/4	3.85	98	1.02	26	1-1/2	2.41	61
11743-16-12	1	3/4	3.85	98	1.02	26	1-3/4	2.41	61
11743-16-16	1	1	4.76	121	1.26	32	1-3/4	3.14	80
11743-20-16	1-1/4	1	4.76	121	1.26	32	2	3.14	80
11743-20-20 [^]	1-1/4	1-1/4	5.61	142	1.50	38	2	3.92	100
11743-20-24	1-1/4	1-1/2	5.45	138	1.38	35	2	4.08	104
11743-24-20 [^]	1-1/2	1-1/4	5.55	141	1.496	38	2-3/8	3.86	98
11743-24-24	1-1/2	1-1/2	5.50	140	1.43	36	2-3/8	4.13	105
11743-32-24	2	1-1/2	5.49	139	1.42	36	2-13/16	4.12	105
11743-32-32	2	2	7.23	184	1.98	50	2-13/16	5.45	138

[^]Must be assembled with Die Part No. 83C-A20H in a Superkrimp or Parkrimp 2.
See Accessories Section for O-Rings and Flange Kits.

12743

SAE Code 61 Flange Head - 60° Elbow

ISO 12151-3 - E60S - L (1 Piece: ISO 12151-3 - E60M - L)

# Part Number	Flange inch	Hose I.D. inch	A		E		F inch	B	
			inch	mm	inch	mm		inch	mm
12743-12-12	3/4	3/4	4.16	105	1.43	36	1-1/2	2.72	69
12743-16-12	1	3/4	4.15	105	1.39	35	1-3/4	2.71	69
12743-16-16	1	1	4.45	113	1.50	38	1-3/4	2.83	72
12743-20-20 ^{^^}	1-1/4	1-1/4	5.09	129	1.69	43	2	3.40	86

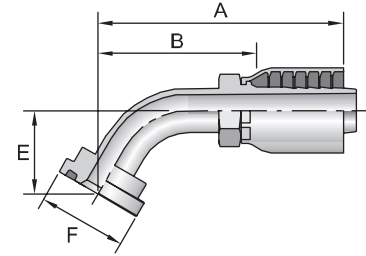

11843

SAE Code 61 Flange Head - 67-1/2° Elbow

ISO 12151-3 - E67S - L (1 Piece: ISO 12151-3 - E67M - L)

# Part Number	Flange inch	Hose I.D. inch	A		E		F inch	B	
			inch	mm	inch	mm		inch	mm
11843-12-12	3/4	3/4	4.09	104	1.60	41	1-1/2	2.66	68
11843-16-16 [^]	1	1	4.66	118	1.75	44	1-3/4	3.07	78
11843-20-20 ^{^^}	1-1/4	1-1/4	5.04	128	1.94	49	2	3.37	86

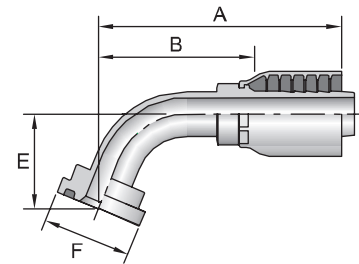

11943

SAE Code 61 Flange Head - 90° Elbow

ISO 12151-3 - E90S - L (1 Piece: ISO 12151-3 - E90M - L)

# Part Number	Flange inch	Hose I.D. inch	A		E		F inch	B	
			inch	mm	inch	mm		inch	mm
11943-8-8	1/2	1/2	2.93	74	1.60	41	1-3/16	1.67	42
11943-10-10	5/8	5/8	3.71	94	2.10	53	1-11/32	2.27	58
11943-12-8	3/4	1/2	2.93	74	1.66	42	1-1/2	1.67	42
11943-12-10	3/4	5/8	3.71	94	2.10	53	1-1/2	2.27	58
11943-12-12	3/4	3/4	3.51	89	2.28	58	1-1/2	2.07	53
11943-16-8	1	1/2	2.91	74	2.03	52	1-3/4	1.65	42
11943-16-12	1	3/4	3.52	89	2.28	58	1-3/4	1.92	53
11943-16-16	1	1	4.28	109	2.78	71	1-3/4	2.66	68
11943-20-16	1-1/4	1	4.25	108	2.76	70	2	2.63	67
11943-20-20 ^{^^}	1-1/4	1-1/4	5.12	130	3.54	90	2	3.43	87
11943-24-20 ^{^^}	1-1/2	1-1/4	5.09	129	3.54	90	2-3/8	3.40	86
11943-20-24	1-1/4	1-1/2	4.19	106	2.49	63	2	2.82	72
11943-24-24	1-1/2	1-1/2	5.50	140	3.11	79	2-3/8	4.13	105
11943-32-24	2	1-1/2	5.48	139	3.10	79	2-13/16	4.11	104
11943-32-32	2	2	6.75	171	4.48	114	2-13/16	4.97	126

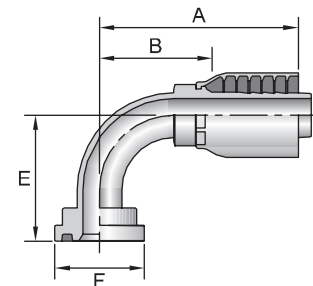

[^]Can not be assembled with KarryKrimp.

^{^^}Must be assembled with Die Part No. 83C-A20H in a Superkrimp or Parkrimp 2.
See Accessories Section for O-Rings and Flange Kits.

Hose
A

Fittings 43 Series
B

Equipment
C

Accessories
D

Technical
E

1J043

Male Seal-Lok® - Rigid - (with O-Ring)

ISO 12151-1 - S

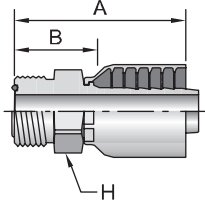

# Part Number	Thread		Hose I.D. inch	A		H inch	B	
	inch	mm		inch	mm		inch	mm
1J043-4-4	1/4	9/16x18	1/4	1.73	44	5/8	0.98	25
1J043-6-6	3/8	11/16x16	3/8	2.08	53	3/4	1.05	27
1J043-8-6	1/2	13/16x16	3/8	2.20	56	7/8	1.17	30
1J043-8-8	1/2	13/16x16	1/2	2.42	61	7/8	1.17	30
1J043-10-8	5/8	1x14	1/2	2.61	66	1-1/16	1.35	34
1J043-10-10	5/8	1x14	5/8	2.73	69	1-1/16	1.34	34
1J043-12-10	3/4	1-3/16x12	5/8	2.89	73	1-1/4	1.45	37
1J043-12-12	3/4	1-3/16x12	3/4	2.90	74	1-1/4	1.46	37
1J043-16-12	1	1-7/16x12	3/4	2.93	74	1-1/2	1.49	38
1J043-16-16	1	1-7/16x12	1	3.29	84	1-1/2	1.67	42
1J043-20-20	1-1/4	1-11/16x12	1-1/4	3.32	84	1-3/4	1.63	41

1JB43

Male Seal-Lok® - Bulkhead without Locknut - (with O-Ring)

ISO 8434-3 - BH

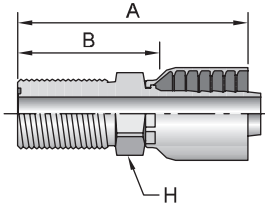

# Part Number	Thread		Hose I.D. inch	A		H inch	B	
	inch	mm		inch	mm		inch	mm
1JB43-4-4	1/4	9/16x18	1/4	2.58	66	5/8	1.83	46
1JB43-6-6	3/8	11/16x16	3/8	2.98	76	3/4	1.95	50
1JB43-8-6	1/2	13/16x16	3/8	3.41	87	7/8	2.38	60
1JB43-8-8	1/2	13/16x16	1/2	3.36	85	7/8	2.10	53
1JB43-10-8	5/8	1x14	1/2	3.58	91	1-1/16	2.32	59
1JB43-10-10	5/8	1x14	5/8	3.77	96	1-1/16	2.33	59
1JB43-12-12	3/4	1-3/16x12	3/4	3.87	98	1-1/4	2.43	62

Fittings are stocked less locknut (part no. WLNL). Locknuts are manufactured by the Parker Tube Fittings Division and must be ordered separately.

See Accessories Section for O-Rings and Flange Kits.

1JC43

Female Seal-Lok® - Swivel - Short

ISO 12151-1 - SWSA

# Part Number	Thread		Hose I.D. inch	A		C		H	W	B		Additional Material Stainless Steel (C)
	inch	inch		inch	mm	inch	mm	inch	inch	inch	mm	
1JC43-4-4	1/4	9/16x18	1/4	1.63	41	0.32	8	9/16	11/16	0.88	22	•
1JC43-4-4-SM	1/4	9/16x18	1/4	1.63	41	0.32	8	17 mm	17 mm	0.88	22	
1JC43-4-6	1/4	9/16x18	3/8	1.90	48	0.32	8	11/16	11/16	0.87	22	
1JC43-6-4	3/8	11/16x16	1/4	1.67	42	0.32	8	11/16	13/16	0.92	23	
1JC43-6-4-SM	3/8	11/16x16	1/4	1.67	42	0.32	8	17 mm	22 mm	0.92	23	
1JC43-6-5	3/8	11/16x16	5/16	1.65	42	0.32	8	11/16	13/16	0.90	23	
1JC43-6-6	3/8	11/16x16	3/8	1.94	49	0.32	8	11/16	13/16	0.91	23	•
1JC43-6-6-SM	3/8	11/16x16	3/8	1.94	49	0.32	8	19 mm	22 mm	0.91	23	
1JC43-8-6	1/2	13/16x16	3/8	2.00	51	0.43	11	13/16	15/16	0.97	25	
1JC43-8-6-SM	1/2	13/16x16	3/8	2.00	51	0.43	11	19 mm	24 mm	0.97	25	
1JC43-8-8	1/2	13/16x16	1/2	2.22	56	0.43	11	13/16	15/16	0.96	24	•
1JC43-8-8-SM	1/2	13/16x16	1/2	2.22	56	0.43	11	22 mm	24 mm	0.96	24	
1JC43-10-8	5/8	1x14	1/2	2.30	58	0.53	13	15/16	1-1/8	1.04	26	
1JC43-10-8-SM	5/8	1x14	1/2	2.30	58	0.53	13	24 mm	30 mm	1.04	26	
1JC43-10-10	5/8	1x14	5/8	2.49	63	0.53	13	15/16	1-1/8	1.05	27	•
1JC43-10-10-SM	5/8	1x14	5/8	2.49	63	0.53	13	24 mm	30 mm	1.05	27	
1JC43-12-8	3/4	1-3/16x12	1/2	2.48	63	0.57	14	1-1/8	1-3/8	1.22	31	
1JC43-12-10	3/4	1-3/16x12	5/8	2.67	68	0.57	14	1-1/8	1-3/8	1.23	31	
1JC43-12-10-SM	3/4	1-3/16x12	5/8	2.67	68	0.57	14	32 mm	36 mm	1.23	31	
1JC43-12-12	3/4	1-3/16x12	3/4	2.68	68	0.57	14	1-1/8	1-3/8	1.24	31	•
1JC43-12-12-SM	3/4	1-3/16x12	3/4	2.68	68	0.57	14	32 mm	36 mm	1.24	31	
1JC43-12-16	3/4	1-3/16x12	1	2.99	76	0.57	14	1-5/16	1-3/8	1.37	35	
1JC43-16-12	1	1-7/16x12	3/4	2.83	72	0.58	15	1-3/8	1-5/8	1.39	35	
1JC43-16-16	1	1-7/16x12	1	3.14	80	0.58	15	1-3/8	1-5/8	1.52	39	•
1JC43-20-20	1-1/4	1-11/16x12	1-1/4	3.27	83	0.59	15	1-7/8	1-7/8	1.58	40	•

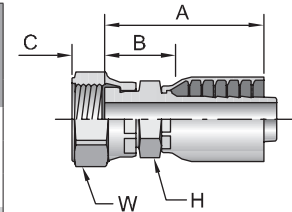

When measuring overall length to the end of the nut, B+C dimensions must be used to calculate cut-off allowance.
Stainless steel fittings must be assembled with Karrykrimp 2, PHastkrimp, Superkrimp or Parkrimp 2.
See CrimpSource for more information.

See Accessories Section for O-Rings.



Hose
A

Fittings 43 Series
B

Equipment
C

Accessories
D

Technical
E

Hose
A

Fittings 43 Series
B

Equipment
C

Accessories
D

Technical
E

1JS43

Female Seal-Lok® - Swivel - Long

ISO 12151-1 SWSB

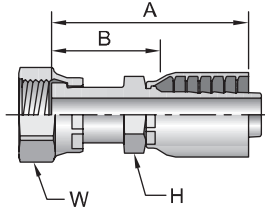

# Part Number	Thread		Hose I.D. inch	A		H		W		B	
	inch	inch		inch	mm	inch	inch	inch	inch	mm	mm
1JS43-4-4	1/4	9/16x18	1/4	2.07	53	9/16	11/16	1.32	34		
1JS43-4-6	1/4	9/16x18	3/8	2.21	56	11/16	11/16	1.18	30		
1JS43-6-4	3/8	11/16x16	1/4	2.14	54	9/16	13/16	1.39	35		
1JS43-6-6	3/8	11/16x16	3/8	2.28	58	11/16	13/16	1.25	32		
1JS43-6-8	3/8	11/16x16	1/2	2.50	64	13/16	13/16	1.24	31		
1JS43-8-4	1/2	13/16x16	1/4	2.26	57	11/16	15/16	1.51	38		
1JS43-8-6	1/2	13/16x16	3/8	2.53	64	11/16	15/16	1.50	38		
1JS43-8-8	1/2	13/16x16	1/2	2.65	67	13/16	15/16	1.39	35		
1JS43-8-10	1/2	13/16x16	5/8	2.82	72	15/16	15/16	1.38	35		
1JS43-10-6	5/8	1x14	3/8	2.63	67	11/16	1-1/8	1.62	41		
1JS43-10-8	5/8	1x14	1/2	2.89	73	13/16	1-1/8	1.63	41		
1JS43-10-10	5/8	1x14	5/8	3.07	78	15/16	1-1/8	1.66	42		
1JS43-10-12	5/8	1x14	3/4	3.08	78	1-1/16	1-1/8	1.64	42		
1JS43-12-8	3/4	1-3/16x12	1/2	2.90	74	15/16	1-3/8	1.64	42		
1JS43-12-10	3/4	1-3/16x12	5/8	3.19	81	1-1/8	1-3/8	1.75	44		
1JS43-12-12	3/4	1-3/16x12	3/4	3.31	84	1-1/8	1-3/8	1.87	47		
1JS43-12-16	3/4	1-3/16x12	1	3.53	90	1-5/16	1-3/8	1.91	49		
1JS43-16-12	1	1-7/16x12	3/4	3.37	86	1-3/8	1-5/8	1.93	49		
1JS43-16-16	1	1-7/16x12	1	3.62	92	1-3/8	1-5/8	2.00	51		
1JS43-16-20	1	1-7/16x12	1-1/4	3.77	96	1-3/4	1-5/8	2.08	53		
1JS43-20-16	1-1/4	1-11/16x12	1	3.64	92	1-3/8	1-7/8	2.02	51		
1JS43-20-20	1-1/4	1-11/16x12	1-1/4	3.77	96	1-3/4	1-7/8	2.15	53		
1JS43-24-20	1-1/2	2x12	1-1/4	3.88	99	1-3/4	2-1/4	2.23	57		
1JS43-24-24	1-1/2	2x12	1-1/2	3.91	99	1-7/8	2-1/4	2.54	65		

1J643

Female Seal-Lok® - Swivel - 22-1/2° Elbow

ISO 8434-3

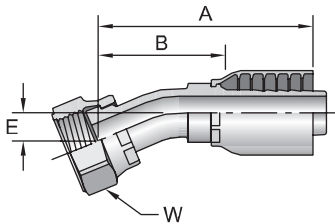

# Part Number	Thread		Hose I.D. inch	A		E		W	B	
	inch	inch		inch	mm	inch	mm		inch	inch
1J643-8-8	1/2	13/16x16	1/2	3.06	78	0.39	10	15/16	1.80	46

See Accessories Section for O-Rings.

1J743

Female Seal-Lok® - Swivel - 45° Elbow

ISO 12151-1 - SWE45

# Part Number	Thread		Hose I.D. inch	A		E		W inch	B	
	inch			inch	mm	inch	mm		inch	mm
1J743-4-4	1/4	9/16x18	1/4	1.97	50	0.39	10	11/16	1.22	31
1J743-4-4-SM	1/4	9/16x18	1/4	1.97	50	0.39	10	17 mm	1.22	31
1J743-4-6	1/4	9/16x18	3/8	2.23	57	0.39	10	11/16	1.20	30
1J743-6-4	3/8	11/16x16	1/4	2.08	53	0.43	11	13/16	1.33	34
1J743-6-4-SM	3/8	11/16x16	1/4	2.08	53	0.43	11	22 mm	1.33	34
1J743-6-5	3/8	11/16x16	5/16	2.37	60	0.43	11	13/16	1.62	41
1J743-6-6	3/8	11/16x16	3/8	2.34	59	0.43	11	13/16	1.31	33
1J743-6-8	3/8	11/16x16	1/2	2.66	68	0.43	11	13/16	1.41	36
1J743-8-4	1/2	13/16x16	1/4	2.56	65	0.59	15	15/16	1.81	46
1J743-8-6	1/2	13/16x16	3/8	2.53	64	0.59	15	15/16	1.50	38
1J743-8-6-SM	1/2	13/16x16	3/8	2.53	64	0.59	15	24 mm	1.50	38
1J743-8-8	1/2	13/16x16	1/2	2.83	72	0.59	15	15/16	1.57	40
1J743-8-8-SM	1/2	13/16x16	1/2	2.83	72	0.59	15	24 mm	1.57	40
1J743-8-10	1/2	13/16x16	5/8	3.09	78	0.59	15	15/16	1.65	42
1J743-10-8	5/8	1x14	1/2	2.93	74	0.63	16	1-1/8	1.67	42
1J743-10-10	5/8	1x14	5/8	3.17	81	0.63	16	1-1/8	1.73	44
1J743-10-10-SM	5/8	1x14	5/8	3.17	81	0.63	16	30 mm	1.73	44
1J743-10-12	5/8	1x14	3/4	3.36	85	0.65	16	1-1/8	1.93	49
1J743-12-8	3/4	1-3/16x12	1/2	3.57	91	0.82	21	1-3/8	2.31	59
1J743-12-10	3/4	1-3/16x12	5/8	3.62	92	0.83	21	1-3/8	2.18	55
1J743-12-12	3/4	1-3/16x12	3/4	3.63	92	0.83	21	1-3/8	2.19	56
1J743-12-12-SM	3/4	1-3/16x12	3/4	3.63	92	0.83	21	36 mm	2.19	56
1J743-12-16	3/4	1-3/16x12	1	3.67	93	0.81	21	1-3/8	2.05	52
1J743-16-12	1	1-7/16x12	3/4	4.02	102	0.94	24	1-5/8	2.59	66
1J743-16-16	1	1-7/16x12	1	4.38	111	0.94	24	1-5/8	2.76	70
1J743-16-20	1	1-7/16x12	1-1/4	4.59	117	0.94	24	1-5/8	2.94	75
1J743-20-16	1-1/4	1-11/16x12	1	4.52	115	1.00	25	1-7/8	2.93	74
1J743-20-20	1-1/4	1-11/16x12	1-1/4	4.78	121	1.00	25	1-7/8	3.09	78
1J743-24-20	1-1/2	2x12	1-1/4	4.99	127	1.11	28	2-1/4	3.30	84
1J743-24-24	1-1/2	2x12	1-1/2	4.70	119	1.07	27	2-1/4	3.33	85

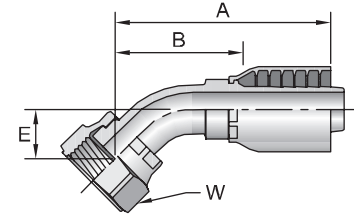

Hose
A

Fittings 43 Series
B

Equipment
C

Accessories
D

Technical
E

See Accessories Section for O-Rings.

Hose
A

Fittings 43 Series
B

Equipment
C

Accessories
D

Technical
E

1J943

Female Seal-Lok® - Swivel - 90° Elbow - Short Drop

ISO 12151-1 - SWES90

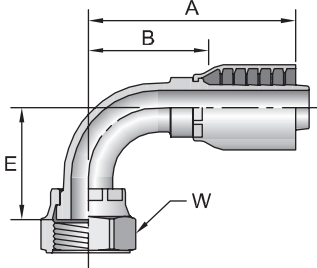

# Part Number	Thread		Hose I.D. inch	A		E		W inch	B	
	inch	mm		inch	mm	inch	mm			
1J943-4-4	1/4	9/16x18	1/4	1.78	45	0.83	21	11/16	1.03	26
1J943-4-6	1/4	9/16x18	3/8	2.05	52	0.83	21	11/16	1.02	26
1J943-6-4	3/8	11/16x16	1/4	1.93	49	0.91	23	13/16	1.18	30
1J943-6-5	3/8	11/16x16	5/16	2.25	57	0.90	23	13/16	1.50	38
1J943-6-6	3/8	11/16x16	3/8	2.21	56	0.91	23	13/16	1.18	30
1J943-6-8	3/8	11/16x16	1/2	2.53	64	0.90	23	13/16	1.27	32
1J943-8-4	1/2	13/16x16	1/4	2.28	58	1.15	29	15/16	1.53	39
1J943-8-6	1/2	13/16x16	3/8	2.28	58	1.14	29	15/16	1.25	32
1J943-8-8	1/2	13/16x16	1/2	2.59	66	1.14	29	15/16	1.33	34
1J943-8-8-SM	1/2	13/16x16	1/2	2.59	66	1.14	29	24 mm	1.33	34
1J943-8-10	1/2	13/16x16	5/8	2.81	71	1.15	29	15/16	1.37	35
1J943-10-8	5/8	1x14	1/2	2.74	70	1.26	32	1-1/8	1.48	38
1J943-10-10	5/8	1x14	5/8	2.97	75	1.26	32	1-1/8	1.53	39
1J943-10-10-SM	5/8	1x14	5/8	2.97	75	1.26	32	30 mm	1.53	39
1J943-10-12	5/8	1x14	3/4	3.08	78	1.27	32	1-1/8	1.64	42
1J943-12-8	3/4	1-3/16x12	1/2	3.21	82	1.89	48	1-3/8	1.95	50
1J943-12-10	3/4	1-3/16x12	5/8	3.49	89	1.89	48	1-3/8	2.05	52
1J943-12-12	3/4	1-3/16x12	3/4	3.06	78	1.89	48	1-3/8	2.05	52
1J943-12-16	3/4	1-3/16x12	1	3.88	99	1.89	48	1-3/8	2.26	57
1J943-16-12	1	1-7/16x12	3/4	4.06	103	2.22	56	1-5/8	2.62	67
1J943-16-16	1	1-7/16x12	1	4.31	109	2.20	56	1-5/8	2.69	68
1J943-16-20	1	1-7/16x12	1-1/4	4.56	116	2.21	56	1-5/8	2.87	73
1J943-20-16	1-1/4	1-11/16x12	1	4.64	118	2.54	65	1-7/8	3.02	80
1J943-20-20	1-1/4	1-11/16x12	1-1/4	4.88	124	2.51	64	1-7/8	3.19	81
1J943-24-20	1-1/2	2x12	1-1/4	4.97	126	2.70	69	2-1/4	3.32	84
1J943-24-24	1-1/2	2x12	1-1/2	5.50	140	2.68	68	2-1/4	4.13	105

1J543

Female Seal-Lok® - Swivel - 90° Elbow - Medium Drop

ISO 12151-1 - SWSB

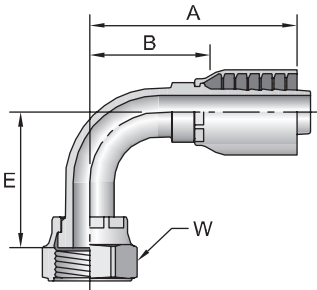

# Part Number	Thread		Hose I.D. inch	A		E		W inch	B	
	inch	mm		inch	mm	inch	mm			
1J543-4-4	1/4	9/16x18	1/4	2.07	53	1.26	32	11/16	1.32	34
1J543-6-4	3/8	11/16x16	1/4	2.12	54	1.50	38	13/16	1.37	35
1J543-6-6	3/8	11/16x16	3/8	2.40	61	1.50	38	13/16	1.37	35
1J543-6-6-SM	3/8	11/16x16	3/8	2.40	61	1.50	38	22 mm	1.37	35
1J543-8-6	1/2	13/16x16	3/8	2.48	63	1.61	41	15/16	1.45	37
1J543-8-8	1/2	13/16x16	1/2	2.59	66	1.61	41	15/16	1.33	34
1J543-10-8	5/8	1x14	1/2	2.74	70	1.85	47	1-1/8	1.48	38
1J543-10-10	5/8	1x14	5/8	2.97	75	1.85	47	1-1/8	1.53	39
1J543-10-12	5/8	1x14	3/4	3.12	79	1.88	48	1-1/8	1.68	43
1J543-12-12	3/4	1-3/16x12	3/4	3.49	89	2.28	58	1-3/8	2.05	52
1J543-16-16	1	1-7/16x12	1	4.86	123	2.78	71	1-5/8	3.27	83
1J543-20-20	1-1/4	1-11/16x12	1-1/4	4.89	124	3.09	78	1-7/8	3.20	81

See Accessories Section for O-Rings.

1J143

Female Seal-Lok® - Swivel - 90° Elbow - Long Drop

ISO 12151-1 - SWEL90

# Part Number	Thread		Hose I.D. inch	A		E		W inch	B	
	inch	mm		inch	mm	inch	mm		inch	mm
1J143-4-4	1/4	9/16x18	1/4	2.02	51	1.81	46	11/16	1.27	32
1J143-6-4	3/8	11/16x16	1/4	2.26	57	2.29	58	13/16	1.51	38
1J143-6-6	3/8	11/16x16	3/8	2.39	61	2.13	54	13/16	1.36	35
1J143-8-6	1/2	13/16x16	3/8	2.45	62	2.52	64	15/16	1.42	36
1J143-8-8	1/2	13/16x16	1/2	2.59	66	2.52	64	15/16	1.33	34
1J143-8-8-SM	1/2	13/16x16	1/2	2.59	66	2.52	64	24 mm	1.33	34
1J143-10-8	5/8	1x14	1/2	2.74	70	2.79	71	1-1/8	1.48	38
1J143-10-10	5/8	1x14	5/8	2.97	75	2.76	70	1-1/8	1.53	39
1J143-10-12	5/8	1x14	3/4	3.15	80	2.76	70	1-1/8	1.73	44
1J143-12-12	3/4	1-3/16x12	3/4	3.49	89	3.78	96	1-3/8	2.05	52
1J143-16-16	1	1-7/16x12	1	4.28	109	4.49	114	1-5/8	2.66	68
1J143-20-20	1-1/4	1-11/16x12	1-1/4	4.84	123	5.09	129	1-7/8	3.15	80
1J143-24-20	1-1/2	2x12	1-1/4	4.77	121	5.54	141	2-1/4	3.12	79

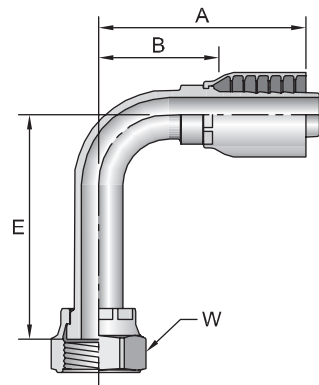

1D043

Male Metric L - Rigid - (24° Cone)

ISO 8434-1

# Part Number	Thread		Hose I.D. inch	A		H mm	B	
	mm	mm		inch	mm		inch	mm
1D043-6-4	6	M12x1,5	1/4	1.73	44	14	0.93	24
1D043-8-4	8	M14x1,5	1/4	1.61	41	14	0.93	24
1D043-10-5	10	M16x1,5	5/16	1.97	50	19	0.83	21
1D043-10-6	10	M16x1,5	3/8	1.97	50	19	0.83	21
1D043-12-5	12	M18x1,5	5/16	1.89	48	19	0.94	24
1D043-12-6	12	M18x1,5	3/8	1.97	50	19	0.83	21
1D043-15-6	15	M22x1,5	3/8	1.93	49	22	1.02	26
1D043-15-8	15	M22x1,5	1/2	2.28	58	22	0.94	24
1D043-18-10	18	M26x1,5	5/8	2.68	68	27	1.14	29
1D043-18-12	18	M26x1,5	3/4	2.68	68	27	1.14	29
1D043-22-12	22	M30x2	3/4	2.72	69	30	1.22	31
1D043-28-16	28	M36x2	1	3.11	79	36	1.30	33
1D043-35-20	35	M45x2	1-1/4	3.35	85	46	1.50	38

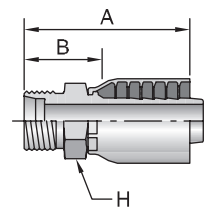

11D43

Male Standpipe Metric L - Rigid

ISO 8434-1

# Part Number	R mm	Hose I.D. inch	A		D		B	
			inch	mm	inch	mm	inch	mm
11D43-6-4	6	1/4	2.03	52	0.87	22	1.28	33
11D43-10-5	10	5/16	2.36	60	0.91	23	1.45	37
11D43-10-6	10	3/8	2.28	58	0.91	23	1.14	29
11D43-12-4	12	1/4	2.17	55	0.91	23	1.22	31
11D43-15-8	15	1/2	2.56	65	0.98	25	1.22	31
11D43-18-10	18	5/8	2.99	76	1.02	26	1.48	38
11D43-18-12	18	3/4	2.80	71	1.02	26	1.22	31
11D43-22-12	22	3/4	2.87	73	1.10	28	1.26	32
11D43-28-16	28	1	3.31	84	1.18	30	1.46	37

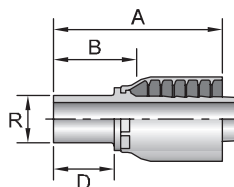

Metric L: Mates with EO "L" Series Fittings. See Accessories Section for O-Rings.

Hose
A

Fittings 43 Series
B

Equipment
C

Accessories
D

Technical
E

1C343

Female Metric L - Swivel - (Ball Nose)

ISO 8434-1

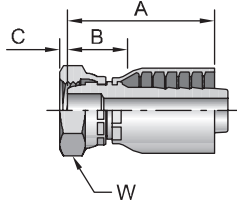

# Part Number	Thread		Hose I.D.	A		C		W	B	
	mm	mm	inch	inch	mm	inch	mm	mm	inch	mm
1C343-6-4	6	M12x1,5	1/4	1.75	44	0.09	2	14	1.16	29
1C343-8-4	8	M14x1,5	1/4	1.77	45	0.11	3	17	1.16	29
1C343-10-5	10	M16x1,5	5/16	2.01	51	0.06	2	19	1.20	30
1C343-10-6	10	M16x1,5	3/8	2.06	52	0.06	2	19	1.10	28
1C343-12-5	12	M18x1,5	5/16	1.87	47	0.10	3	22	0.70	18
1C343-12-6	12	M18x1,5	3/8	2.23	57	0.10	3	22	1.18	30
1C343-15-6	6	M22x1,5	3/8	1.85	47	0.16	4	27	0.71	18
1C343-15-8	15	M22x1,5	1/2	2.42	61	0.17	4	27	1.29	33
1C343-18-10	18	M26x1,5	5/8	2.65	67	0.10	3	32	1.23	31
1C343-18-12	18	M26x1,5	3/4	2.80	71	0.10	3	32	1.37	35
1C343-22-12	22	M30x2	3/4	2.87	73	0.18	5	36	1.42	36
1C343-28-16	28	M36x2	1	3.35	85	0.22	6	46	1.76	45

When measuring overall length to the end of the nut, B+C dimensions must be used to calculate cut-off allowance.

1C443

Female Metric L - Swivel - 45° Elbow - (Ball Nose)

ISO 8434-1

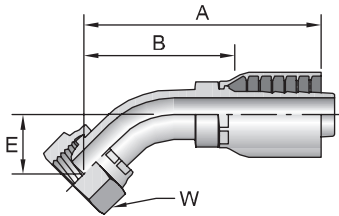

# Part Number	Thread		Hose I.D.	A		E		W	B	
	mm	mm	inch	inch	mm	inch	mm	mm	inch	mm
1C443-8-4	8	M14x1,5	1/4	2.40	61	0.59	15	17	1.50	38
1C443-10-5	10	M16x1,5	5/16	2.60	66	0.67	17	19	1.61	41
1C443-10-6	10	M16x1,5	3/8	2.76	70	0.67	17	19	1.61	41
1C443-12-6	12	M18x1,5	3/8	2.76	70	0.67	17	22	1.61	41
1C443-15-8	15	M22x1,5	1/2	3.35	85	0.79	20	27	1.97	50
1C443-18-10	18	M26x1,5	5/8	4.09	104	1.14	29	32	2.52	64
1C443-22-12	22	M30x2	3/4	3.78	96	0.91	23	36	2.20	56
1C443-28-16	28	M36x2	1	4.53	115	1.10	28	46	2.81	71

1C543

Female Metric L - Swivel - 90° Elbow - (Ball Nose)

ISO 8434-1

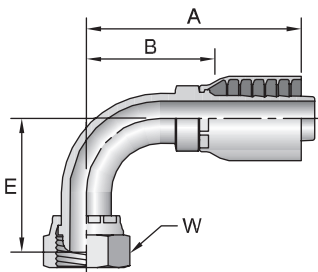

# Part Number	Thread		Hose I.D.	A		E		W	B	
	mm	mm	inch	inch	mm	inch	mm	mm	inch	mm
1C543-8-4	8	M14x1,5	1/4	2.05	52	1.10	28	17	1.18	30
1C543-10-5	10	M16x1,5	5/16	2.20	56	1.18	30	19	1.22	31
1C543-10-6	10	M16x1,5	3/8	2.40	61	1.18	30	19	1.40	36
1C543-12-6	12	M18x1,5	3/8	2.40	61	1.22	31	22	1.40	36
1C543-15-8	15	M22x1,5	1/2	2.95	75	1.57	40	27	1.57	40
1C543-18-10	18	M26x1,5	5/8	3.58	91	2.36	60	32	2.05	52
1C543-22-12	22	M30x2	3/4	3.58	91	1.97	50	36	2.00	51
1C543-28-16	28	M36x2	1	4.33	110	2.48	63	46	2.56	65

Metric L: Mates with EO "L" Series Fittings.

1CA43

Female Metric L - Swivel - (24° Cone with O-Ring)

ISO 12151-2 - SWS

# Part Number	Thread mm	Hose I.D. inch	A		C		W mm	B	
			inch	mm	inch	mm		inch	mm
1CA43-6-4	6	M12x1,5	1/4	1.73	44	-0.02	14	0.88	22
1CA43-8-4	8	M14x1,5	1/4	1.73	44	-0.01	17	0.88	22
1CA43-8-5	8	M14x1,5	5/16	2.01	51	0.00	17	1.02	26
1CA43-10-4	10	M16x1,5	1/4	1.81	46	0.04	19	0.87	22
1CA43-10-5	10	M16x1,5	5/16	1.73	44	0.04	19	0.82	21
1CA43-12-5	12	M18x1,5	5/16	1.81	46	0.04	22	0.91	23
1CA43-12-6	12	M18x1,5	3/8	1.89	48	0.03	22	0.75	19
1CA43-15-8	15	M22x1,5	1/2	2.20	56	0.07	27	0.82	21
1CA43-18-10	18	M26x1,5	5/8	2.44	62	0.02	32	0.87	22
1CA43-18-12	18	M26x1,5	3/4	2.56	65	0.02	32	1.02	26
1CA43-22-12	22	M30x2	3/4	2.83	72	0.13	36	1.30	33
1CA43-28-16	28	M36x2	1	3.07	78	0.14	41	1.30	33
1CA43-35-20	35	M45x2	1-1/4	3.28	83	0.00	50	1.55	39

When measuring overall length to the end of the nut, B+C dimensions must be used to calculate cut-off allowance.

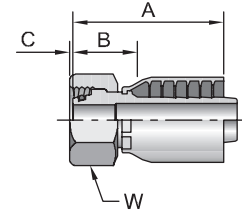

1CE43

Female Metric L - Swivel - 45° Elbow - (24° Cone with O-Ring)

ISO 12151-2 - SWE45

# Part Number	Thread mm	Hose I.D. inch	A		E		W mm	B	
			inch	mm	inch	mm		inch	mm
1CE43-6-4	6	M12x1,5	1/4	2.68	68	0.75	19	1.77	45
1CE43-8-4	8	M14x1,5	1/4	2.32	59	0.63	16	1.38	35
1CE43-10-5	10	M16x1,5	5/16	2.64	67	0.63	16	1.73	44
1CE43-10-6	10	M16x1,5	3/8	2.95	75	0.73	19	1.85	47
1CE43-12-6	12	M18x1,5	3/8	2.72	69	0.87	22	1.53	39
1CE43-15-8	15	M22x1,5	1/2	3.39	86	0.87	22	2.00	51
1CE43-18-10	18	M26x1,5	5/8	3.58	91	0.98	25	2.05	52
1CE43-22-12	22	M30x2	3/4	3.82	97	0.98	25	2.28	58

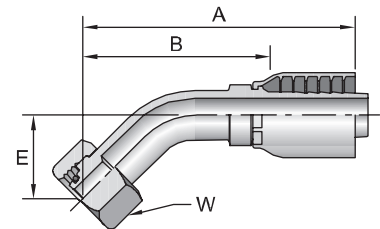

1CF43

Female Metric L - Swivel - 90° Elbow - (24° Cone with O-Ring)

ISO 12151-2 - SWE

# Part Number	Thread mm	Hose I.D. inch	A		E		W mm	B	
			inch	mm	inch	mm		inch	mm
1CF43-8-4	8	M14x1,5	1/4	2.01	51	1.14	29	1.10	28
1CF43-10-5	10	M16x1,5	5/16	2.3	58	1.16	29	1.46	37
1CF43-10-6	10	M16x1,5	3/8	2.56	65	1.38	35	1.58	40
1CF43-12-5	12	M18x1,5	5/16	2.40	61	1.18	30	1.46	37
1CF43-12-6	12	M18x1,5	3/8	2.52	64	1.22	31	1.38	35
1CF43-15-8	15	M22x1,5	1/2	2.80	71	1.65	42	1.46	37
1CF43-18-10	18	M26x1,5	5/8	3.17	81	1.77	45	1.71	43
1CF43-22-12	22	M30x2	3/4	3.50	89	2.09	53	1.93	49
1CF43-35-20	35	M45x2	1-1/4	4.72	120	3.11	79	2.87	73

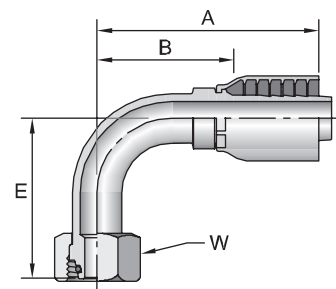

Metric L: Mates with EO "L" Series Fittings.

Hose
A

Fittings 43 Series
B

Equipment
C

Accessories
D

Technical
E

Hose
A

Fittings 43 Series
B

Equipment
C

Accessories
D

Technical
E

1D243

Male Metric S - Rigid - (24° Cone)

ISO 8434-1

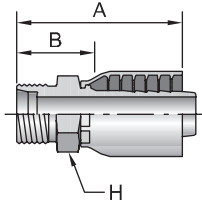

# Part Number	Thread		Hose I.D.		A		H		B	
	mm		inch		inch	mm	mm	inch	mm	
1D243-8-4	8	M16x1,5	1/4		1.73	44	17	0.87	22	
1D243-10-4	10	M18x1,5	1/4		1.73	44	19	0.87	22	
1D243-12-5	12	M20x1,5	5/16		2.20	56	22	1.29	33	
1D243-12-6	12	M20x1,5	3/8		1.97	50	22	1.02	26	
1D243-14-6	14	M22x1,5	3/8		2.17	55	22	0.98	25	
1D243-16-8	16	M24x1,5	1/2		2.36	60	24	1.17	30	
1D243-20-10	20	M30x2	5/8		2.95	75	30	1.44	37	
1D243-25-12	25	M36x2	3/4		2.87	73	36	1.30	33	
1D243-30-16	30	M42x2	1		3.39	86	46	1.54	39	

13D43

Male Standpipe Metric S - Rigid

ISO 8434-1

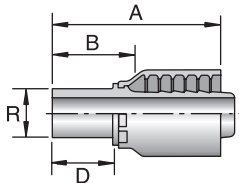

# Part Number	R mm	Hose I.D.		A		D		B	
		inch		inch	mm	inch	mm	inch	mm
13D43-10-4	10	1/4		2.13	54	1.02	26	1.26	32
13D43-12-5	12	5/16		2.52	64	1.02	26	1.61	41
13D43-14-6	14	3/8		2.52	64	1.14	29	1.38	35
13D43-16-8	16	1/2		2.68	68	1.18	30	1.42	36
13D43-20-10	20	5/8		3.39	86	1.42	36	1.88	48
13D43-20-12	20	3/4		3.19	81	1.42	36	1.57	40
13D43-25-12	25	3/4		3.35	85	1.57	40	1.73	44
13D43-30-16	30	1		3.82	97	1.73	44	2.01	51

Light Series 11D43-6-4, 11D43-8-4 and 11D43-12-6 are used in place of their Heavy Series equivalent size and accept the EO Heavy "S" Series ferrules and nuts.

1C643

Female Metric S - Swivel - (Ball Nose)

ISO 8434-1

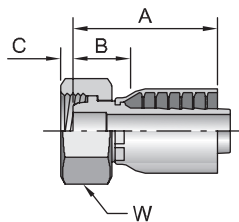

# Part Number	Thread		Hose I.D.		A		C		W		B	
	mm		inch		inch	mm	inch	mm	mm	inch	mm	
1C643-8-4	8	M16x1,5	1/4		1.57	40	0.15	4	19	1.20	30	
1C643-10-4	10	M18x1,5	1/4		1.63	41	0.10	3	22	1.20	30	
1C643-12-5	12	M20x1,5	5/16		1.87	47	0.08	2	24	1.20	30	
1C643-12-6	12	M20x1,5	3/8		1.76	45	0.08	2	24	1.32	34	
1C643-12-8	12	M20x1,5	1/2		2.18	55	0.08	2	24	1.30	33	
1C643-14-6	14	M22x1,5	3/8		1.94	49	0.17	4	27	1.32	34	
1C643-16-8	16	M24x1,5	1/2		2.13	54	0.19	5	30	1.39	35	
1C643-20-10	20	M30x2	5/8		2.38	60	0.21	5	36	1.39	35	
1C643-20-12	20	M30x2	3/4		2.46	62	0.21	5	40	1.03	37	
1C643-25-12	25	M36x2	3/4		2.48	63	0.28	7	46	1.56	40	
1C643-30-16	30	M42x2	1		2.89	73	0.37	9	50	1.95	50	

Metric L: Mates with EO "L" Series Fittings.
Metric S: Mates with EO "S" Series Fittings.

1C043

Female Metric - Swivel - (Ball Nose)

# Part Number	Thread		Hose I.D.		A		C		W		B	
	mm		inch		inch	mm	inch	mm	mm	inch	mm	
1C043-20-12	20	M30x1,5	3/4		2.48	63	0.21	5	36	0.94	24	
1C043-25-16	25	M38x1,5	1		2.99	76	0.28	7	46	1.14	29	

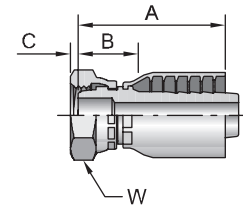

1C943

Female Metric S - Swivel - (24° Cone with O-Ring)

ISO 12151-2 - SWS

# Part Number	Thread		Hose I.D.		A		C		W		B	
	mm		inch		inch	mm	inch	mm	mm	inch	mm	
1C943-6-4	6	M14x1,5	1/4		1.89	48	0.01	0	17	1.02	26	
1C943-8-4	8	M16x1,5	1/4		1.77	45	0.01	0	19	0.91	23	
1C943-10-4	10	M18x1,5	1/4		1.64	42	0.01	0	22	1.18	30	
1C943-10-5	10	M18x1,5	5/16		1.81	46	0.01	0	22	0.87	22	
1C943-10-6	10	M18x1,5	3/8		1.97	50	0.01	0	22	0.83	21	
1C943-12-5	12	M20x1,5	5/16		1.80	46	0.03	1	24	0.99	25	
1C943-12-5	12	M20x1,5	5/16		1.89	48	0.03	1	24	0.94	24	
1C943-12-6	12	M20x1,5	3/8		2.05	52	0.03	1	24	0.87	22	
1C943-14-6	14	M22x1,5	3/8		2.05	52	0.03	1	27	1.17	30	
1C943-16-8	16	M24x1,5	1/2		2.33	59	0.09	2	30	0.94	24	
1C943-20-10	20	M30x2	5/8		2.59	66	0.05	1	36	1.06	27	
1C943-20-12	20	M30x2	3/4		2.59	66	0.05	1	36	1.06	27	
1C943-25-12	25	M36x2	3/4		2.67	68	0.10	3	46	1.24	31	
1C943-25-16	25	M36x2	1		3.05	77	0.08	2	46	1.43	36	
1C943-30-16	30	M42x2	1		3.19	81	0.19	5	50	1.60	41	
1C943-38-20 ^{^^}	38	M52x2	1-1/4		3.35	85	0.23	6	60	1.70	43	

^{^^}Must be assembled with Die Part No. 83C-A20H in a Superkrimp or Parkrimp 2.

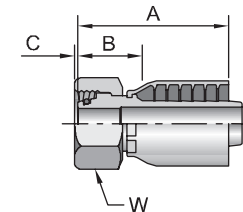

10C43

Female Metric S - Swivel - 45° Elbow - (24° Cone with O-Ring)

ISO 12151-2 - SWE45

# Part Number	Thread		Hose I.D.		A		E		W		B	
	mm		inch		inch	mm	inch	mm	mm	inch	mm	
10C43-8-4	8	M16x1,5	1/4		2.32	59	0.63	16	19	1.38	35	
10C43-12-5	12	M20x1,5	5/16		2.80	71	0.67	17	24	1.85	47	
10C43-12-6	12	M20x1,5	3/8		3.28	83	0.87	22	24	2.28	58	
10C43-16-8	16	M24x1,5	1/2		3.23	82	0.96	24	30	1.89	48	
10C43-20-10	20	M30x2	5/8		4.78	121	1.12	28	36	3.37	86	
10C43-20-12	20	M30x2	3/4		3.94	100	1.14	29	36	2.36	60	
10C43-25-12	25	M36x2	3/4		3.97	101	1.06	27	46	2.40	61	
10C43-30-16	30	M42x2	1		4.65	118	1.22	31	50	2.87	73	
10C43-38-20 ^{^^}	38	M52x2	1-1/4		4.96	126	1.30	33	60	1.89	48	

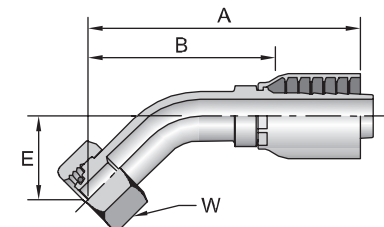

Hose
A

Fittings 43 Series
B

Equipment
C

Accessories
D

Technical
E

11C43

Female Metric S - Swivel - 90° Elbow - (24° Cone with O-Ring)
ISO 12151-2 - SWE

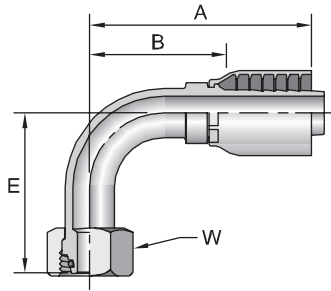

# Part Number	Thread		Hose I.D. inch	A		E		W		B	
	mm			inch	mm	inch	mm	mm	inch	mm	
11C43-8-4	8	M16x1,5	1/4	1.83	46	1.26	32	19	1.41	36	
11C43-10-4	10	M18x1,5	1/4	2.45	62	1.34	34	22	1.71	43	
11C43-12-5	12	M20x1,5	5/16	2.30	58	1.22	31	24	1.51	38	
11C43-12-6	12	M20x1,5	3/8	2.36	60	1.22	31	24	1.42	36	
11C43-14-6	14	M22x1,5	3/8	2.35	60	1.48	38	27	1.35	34	
11C43-16-8	16	M24x1,5	1/2	2.83	72	1.75	44	30	1.46	37	
11C43-20-10	20	M30x2	5/8	3.45	88	2.17	55	36	2.04	52	
11C43-25-12	25	M36x2	3/4	3.74	95	2.17	55	46	2.22	56	
11C43-30-16	30	M42x2	1	4.45	113	2.64	67	50	2.64	67	
11C43-38-20 ^M	38	M52x2	1-1/4	5.67	144	2.87	73	60	2.99	76	

1D943

Male BSP Parallel Pipe - Rigid - (60° Cone)
ISO 228-1

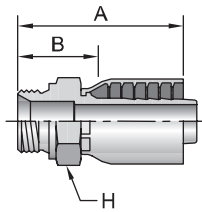

# Part Number	Thread inch	Hose I.D. inch	A		H mm	B	
			inch	mm		inch	mm
1D943-4-4	1/4x19	1/4	1.77	45	19	0.91	23
1D943-6-5	3/8x19	5/16	2.13	54	22	1.22	31
1D943-6-6	3/8x19	3/8	2.13	54	22	1.22	31
1D943-8-6	1/2x14	3/8	2.36	60	27	1.22	31
1D943-8-8	1/2x14	1/2	2.44	62	27	1.10	28
1D943-12-12	3/4x14	3/4	2.76	70	32	1.18	30
1D943-16-16	1x11	1	3.23	82	41	1.38	35

When used in a port, a bonded seal must be used. See Accessories Section for more information.

19243

Female BSP Parallel Pipe - Swivel - (60° Cone)
ISO 228-1

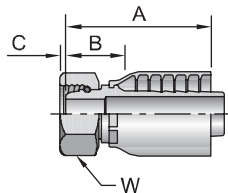

# Part Number	Thread inch	Hose I.D. inch	A		C		W mm	B	
			inch	mm	inch	mm		inch	mm
19243-2-4	1/8x28	1/4	1.61	41	0.20	5	14	0.67	17
19243-4-4	1/4x19	1/4	1.95	50	0.22	6	19	1.20	30
19243-6-4	3/8x19	1/4	1.73	44	0.26	7	22	0.79	20
19243-6-6	3/8x19	3/8	2.35	60	0.26	7	22	1.32	34
19243-6-8	3/8x19	1/2	2.17	55	0.26	7	22	0.79	20
19243-8-6	1/2x14	3/8	2.01	51	0.28	7	27	0.87	22
19243-8-8	1/2x14	1/2	2.72	69	0.28	7	27	1.46	37
19243-10-8	5/8x14	1/2	2.80	71	0.37	9	30	1.54	39
19243-10-10	5/8x14	5/8	2.99	76	0.37	9	30	1.55	39
19243-12-10	3/4x14	5/8	3.11	79	0.35	9	36	1.67	42
19243-12-12	3/4x14	3/4	3.19	81	0.35	9	36	1.75	44
19243-16-16	1x11	1	3.67	93	0.44	11	41	2.05	52
19243-20-20	1-1/4	1-1/4	3.11	79	0.41	11	50	1.26	32

When measuring overall length to the end of the nut, B+C dimensions must be used to calculate cut-off allowance.

1B143

Female BSP Parallel Pipe - Swivel - 45° Elbow - (60° Cone)

ISO 228-1

# Part Number	Thread inch	Hose I.D. inch	A		E		W mm	B	
			inch	mm	inch	mm		inch	mm
1B143-4-4	1/4x19	1/4	2.44	62	0.63	16	19	1.54	39
1B143-6-6	3/8x19	3/8	3.25	83	0.79	20	22	2.25	57
1B143-8-8	1/2x14	1/2	3.35	85	0.79	20	27	1.97	50
1B143-10-10	5/8x14	5/8	4.03	102	0.85	22	30	2.62	67
1B143-12-10	3/4x14	5/8	4.09	104	1.14	29	32	2.52	64
1B143-12-12	3/4x14	3/4	4.02	102	1.14	29	32	2.44	62
1B143-16-16	1x11	1	4.53	115	1.14	29	41	2.76	70

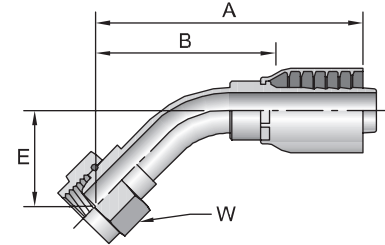

1B243

Female BSP Parallel Pipe - Swivel - 90° Elbow - (60° Cone)

ISO 228-1

# Part Number	Thread inch	Hose I.D. inch	A		E		W mm	B	
			inch	mm	inch	mm		inch	mm
1B243-2-4	1/8x28	1/4	1.97	50	1.10	28	14	1.02	26
1B243-4-4	1/4x19	1/4	1.83	46	1.12	28	19	1.08	27
1B243-6-6	3/8x19	3/8	2.32	59	1.46	37	22	1.32	34
1B243-8-6	1/2x14	3/8	2.60	66	1.38	35	27	1.46	37
1B243-8-8	1/2x14	1/2	2.95	75	1.57	40	27	1.57	40
1B243-10-8	5/8x14	1/2	2.91	74	1.57	40	30	1.54	39
1B243-10-10	5/8x14	5/8	3.13	80	1.57	40	30	1.72	44
1B243-12-10	3/4x14	5/8	3.62	92	2.32	59	32	2.05	52
1B243-12-12	3/4x14	3/4	3.58	91	2.32	59	32	2.00	51
1B243-16-16	1x11	1	4.33	110	2.48	63	41	2.56	65
1B243-20-20	1-1/4x11	1-1/4	4.72	120	2.99	76	50	2.87	73

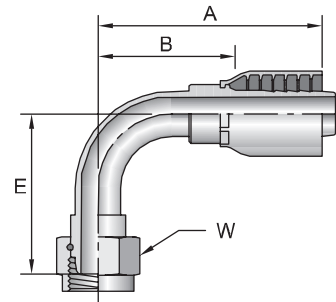

1B443

Female BSP Parallel Pipe - Swivel - 90° Elbow - Block Type - (60° Cone)

ISO 228-1

# Part Number	Thread inch	Hose I.D. inch	A		E		H	W	B	
			inch	mm	inch	mm	mm	mm	inch	mm
1B443-4-4	1/4x19	1/4	2.40	61	1.14	29	17	19	1.40	36
1B443-6-6	3/8x19	3/8	2.76	70	1.02	26	19	22	1.42	36
1B443-8-8	1/2x14	1/2	3.19	81	1.02	26	22	27	1.57	40
1B443-12-12	3/4x14	3/4	3.30	84	1.30	33	23	32	0.98	25

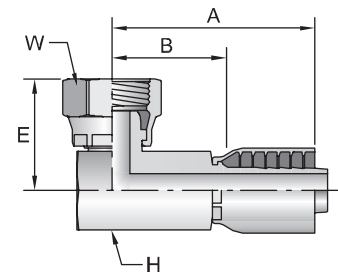

Metric S: Mates with EO "S" Series Fittings.

When measuring overall length to the end of the nut, B+C dimensions must be used to calculate cut-off allowance.

Hose
A

Fittings 43 Series
B

Equipment
C

Accessories
D

Technical
E

1B543

Female BSP Parallel Pipe - Swivel - (Flat Seat)

ISO 228-1

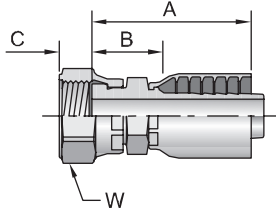

# Part Number	Thread inch	Hose I.D. inch	A		C		W	B	
			inch	mm	inch	mm	mm	inch	mm
1B543-6-6	3/8x19	3/8	1.93	49	0.35	9	22	0.79	20
1B543-8-6	1/2x14	3/8	1.89	48	0.43	11	27	0.75	19
1B543-8-8	1/2x14	1/2	2.28	58	0.43	11	27	0.94	24
1B543-12-12	3/4x14	3/4	2.28	58	0.33	8	32	0.94	24

When measuring overall length to the end of the nut, B+C dimensions must be used to calculate cut-off allowance.

14943

DIN Metric Banjo

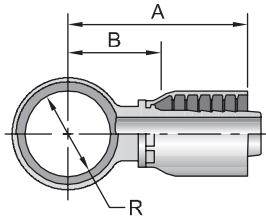

# Part Number	R mm	Hose I.D. inch	A		B	
			inch	mm	inch	mm
14943-10-4	10		1.85	47	0.94	24
14943-12-4	12	1/4	1.85	47	0.98	25
14943-14-5	14	5/16	2.01	51	1.06	27
14943-16-6	16	3/8	2.28	58	1.14	29
14943-18-8	18	1/2	2.60	66	1.22	31
14943-22-10	22	5/8	2.91	74	1.38	35
14943-26-12	26	3/4	3.07	78	1.54	39

AM Banjo Bolt w/DIN Metric Thread

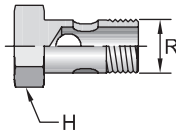

# Part Number	R Thread mm	H mm	Copper Washer 2
AM-03	8	M8x1	853009-8
AM-04	10	M10x1	853009-10
AM-06	12	M12x1,5	853009-12
AM-08	14	M14x1,5	853009-14
AM-10	16	M16x1,5	853009-16
AM-13	18	M18x1,5	853009-18
AM-16	22	M22x1,5	853009-22
AM-20	26	M26x1,5	853009-26
AM-30	30	M30x1,5	853009-30

Two (2) copper washers per bolt must be ordered separately.

Metric S: Mates with EO "S" Series Fittings.

^^Must be assembled with Die Part No. 83C-A20H in a Superkrimp or Parkrimp 2.

1MU43

Female Metric - Swivel - (30° Flare)

# Part Number	Thread mm	Hose I.D. inch	A		H mm	W mm	B	
			inch	mm			inch	mm
1MU43-4-4	M14x1,5	1/4	2.07	53	19	19	1.32	34
1MU43-6-4	M18x1,5	1/4	2.18	55	24	24	1.43	36
1MU43-6-6	M18x1,5	3/8	2.45	62	24	24	1.42	36
1MU43-8-8	M22x1,5	1/2	2.84	72	27	27	1.58	40

Japanese Fittings - Female Swivel 30° Flare with Metric Threads. All 30° flared fitting sizes are available by combining the 1MU43 fittings in sizes up to -8 with the 1XU43 fittings in sizes -10 and larger.

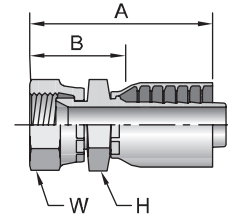

1XU43

Female Metric - Swivel - (30° Flare)

# Part Number	Thread mm	Hose I.D. inch	A		H mm	W mm	B	
			inch	mm			inch	mm
1XU43-10-10	M24x1,5	5/8	3.25	83	30	32	1.81	46
1XU43-12-12	M30x1,5	3/4	3.40	86	32	36	1.96	50
1XU43-16-16	M33x1,5	1	4.03	102	36	41	2.41	61
1XU43-20-20	M36x1,5	1-1/4	4.19	106	46	46	2.50	64
1XU43-24-24	M42x1,5	1-1/2	4.12	105	50	55	2.75	70

Japanese Fittings - Female Swivel 30° Flare with Metric Threads. All 30° flared fitting sizes are available by combining the 1MU43 fittings in sizes up to -8 with the 1XU43 fittings in sizes -10 and larger.

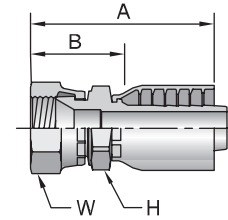

Hose
A

Fittings 43 Series
B

Equipment
C

Accessories
D

Technical
E

Hose
A

Fittings 43 Series
B

Equipment
C

Accessories
D

Technical
E

1FU43

Female BSP Parallel Pipe - Swivel - (30° Flare)

ISO 228-1

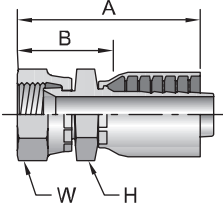

# Part Number	Thread inch	Hose I.D. inch	A		H		W		B	
			inch	mm	mm	mm	inch	mm		
1FU43-4-4	1/4x19	1/4	1.90	48	19	19	1.15	29		
1FU43-6-6	3/8x19	3/8	2.32	59	22	22	1.29	33		
1FU43-8-8	1/2x14	1/2	2.66	68	27	27	1.40	36		
1FU43-12-12	3/4x14	3/4	3.06	78	36	36	1.62	41		
1FU43-16-16	1x11	1	3.53	90	41	41	1.91	49		
1FU43-20-20	1-1/4x11	1-1/4	3.87	98	50	50	2.18	55		

1UT43

Male BSP Taper Pipe - Rigid - (60° Cone)

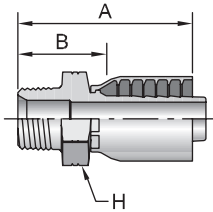

# Part Number	Thread inch	Hose I.D. inch	A		H	B	
			inch	mm	mm	inch	mm
1UT43-4-4	1/4x19	1/4	1.92	49	19	1.17	30
1UT43-6-6	3/8x19	3/8	2.25	57	22	1.22	31
1UT43-8-8	1/2x14	1/2	2.68	68	27	1.42	36
1UT43-12-12	3/4x14	3/4	2.96	75	36	1.53	39
1UT43-16-16	1x11	1	3.48	88	41	1.86	47
1UT43-20-20	1-1/4x11	1-1/4	3.75	95	50	2.10	53

1GU43

Female BSP Parallel Pipe - Swivel - (60° Cone)

ISO 228-1

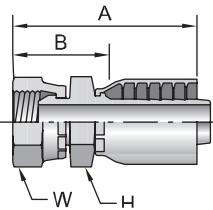

# Part Number	Thread inch	Hose I.D. inch	A		H	W	B	
			inch	mm	mm	mm	inch	mm
1GU43-4-4	1/4x19	1/4	2.08	53	19	19	1.33	34
1GU43-6-6	3/8x19	3/8	2.45	62	22	22	1.42	36
1GU43-8-8	1/2x14	1/2	2.81	71	27	27	1.56	40
1GU43-12-12	3/4x14	3/4	3.24	82	36	36	1.81	46
1GU43-16-16	1x11	1	3.74	95	41	41	2.12	54
1GU43-20-20	1-1/4x11	1-1/4	4.07	103	50	50	2.38	60

1F443

Female French Gaz Series - Swivel - (Ball Nose)

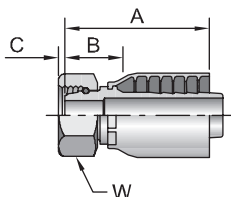

# Part Number	Thread mm	Hose I.D. inch	A		C		W	B	
			inch	mm	inch	mm	mm	inch	mm
1F443-27-12	27 M36x1,5	3/4	3	76	0.14	4	55	1.14	29

When measuring overall length to the end of the nut, B+C dimensions must be used to calculate cut-off allowance.

Universal Push-to-Connect (UPTC) Introduction

Traditionally, the fluid power industry has used threaded connectors to make a leak free connection. The speed of making connections is slow and the reliability of the connection is dependent on proper assembly procedures. Parker's UPTC connectors rely on a mechanical retaining mechanism (other than threads) to create a seal.

Tools are not required for assembly, and the reliability and speed of making connections with the UPTC design is greatly improved compared to traditional threaded connections.

Design and Construction

UPTC Seal-Lok consists of a base Seal-Lok ORFS fitting, a UPTC nut (including internal sealing and retaining elements), a dust O-Ring, and a UPTC hose assembly or rigid tube, as shown in figure 1. The base ORFS fitting is a highly reliable and widely available off-the-shelf standard SAE J1453 adapter. The sealing O-Ring is supported by a pressure energized anti-extrusion ring that prevents O-Ring extrusion and ensures tight sealing even under high pressure.

Once fully engaged, the retaining element is positively trapped between the male and UPTC nut. The dust O-Ring keeps contamination out and serves as a full engagement visual indicator. A clear tactile feeling at the end of the push indicates a proper connection. Once a proper connection is made, the dust O-Ring is covered by the UPTC nut. This also serves as a positive visual indicator of full engagement for easy inspection and quality control.

Once connected, the UPTC nut is permanently attached to the UPTC hose end similar to a traditional swivel nut. To disconnect, just use a wrench to unscrew the UPTC nut from the base adapter. Re-connect is possible by tightening the UPTC nut back to the base adapter, if the connection is not damaged. If the hose or tube is damaged, they can be replaced by installing a new UPTC assembly or a readily available standard Seal-Lok ORFS hose or tube assembly.

Features

- Available in sizes 1/4", 3/8", 1/2", 5/8", and 3/4"
- Uses standard Seal-Lok adapters for a wide variety of configurations, as well as excellent field serviceability
- Meets or exceeds SAE 100R2 pressure ratings (see Fig. 2)
- Includes visual and tactile installation indicators
- Seal-aligning nipple eliminates hose twist during assembly
- No special tooling required for disassembly
- Uses elastomeric seals, including Parker's patented Trap-Seal

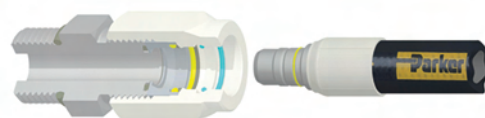

Fig. 1a

Fig. 1b

Fig. 1a — This is a Tube Fittings Division part. Information can be found in Catalog 4300.

UPTC Pressure Ratings

Size	Pressure (psi)	Pressure (Bar)
-4	5800	400
-6	5000	345
-8	4250	293
-10	4000	276
-12	3125	216

Hose
A

Fittings 43 Series
B

Equipment
C

Accessories
D

Technical
E

Hose
A

Fittings 43 Series
B

Equipment
C

Accessories
D

Technical
E

1EN43 UPTC Male

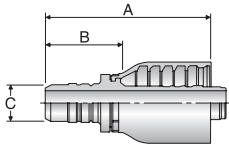

Part Number	Hose End Size inch	A inch	B inch	inch	C Nominal Connection Size mm
1EN43-8-4	1/4	1.83	1.08	0.31	8
1EN43-12-6	3/8	2.15	1.12	0.47	12
1EN43-15-8	1/2	2.51	1.25	0.59	15
1EN43-18-10	5/8	2.78	1.34	0.71	18
1EN43-22-12	3/4	2.81	1.37	0.87	22

1ET43 UPTC Male 90° Elbow

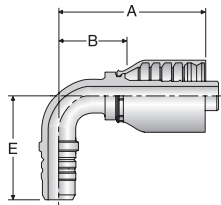





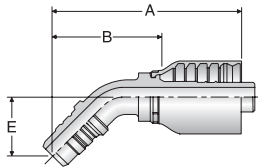



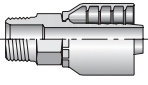

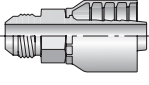
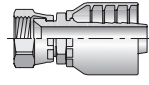
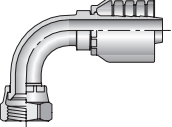

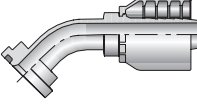
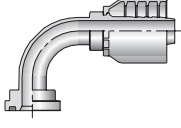

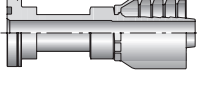
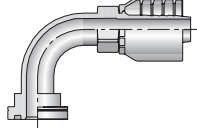

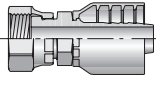
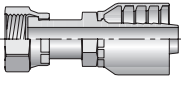
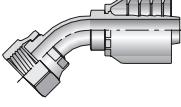
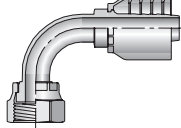
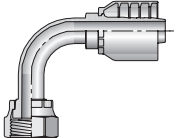
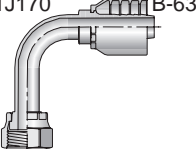
Part Number	Hose End Size inch	A inch	B inch	inch	C Nominal Connection Size mm	E inch
1ET43-8-4	1/4	1.78	1.03	0.31	8	1.54
1ET43-12-6	3/8	2.21	1.18	0.47	12	1.54
1ET43-15-8	1/2	2.51	1.25	0.59	15	1.77
1ET43-18-10	5/8	2.97	1.53	0.71	18	2.24
1ET43-22-12	3/4	3.43	1.99	0.87	22	2.50

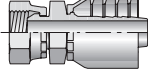
1EU43 UPTC Male 45° Elbow

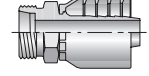

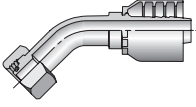
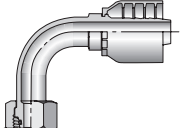
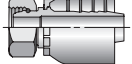
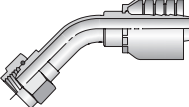
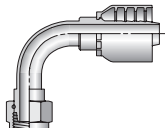
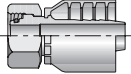
Part Number	Hose End Size inch	A inch	B inch	inch	C Nominal Connection Size mm	E inch
1EU43-8-4	1/4	2.48	1.73	0.31	8	0.91
1EU43-12-6	3/8	2.83	1.80	0.47	12	0.91
1EU43-15-8	1/2	3.17	1.91	0.59	15	0.99
1EU43-18-10	5/8	3.68	2.24	0.71	18	1.26
1EU43-22-12	3/4	3.76	2.32	0.87	22	1.30

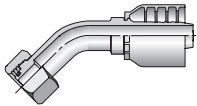
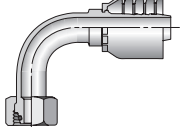
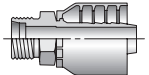
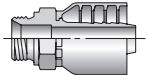
 NPTF Pipe	10170 B-60  <i>Male - Rigid</i>	 JIC 37°	10370 B-60  <i>Male - Rigid</i>	10670 B-60  <i>Female - Swivel</i>	13970 B-60  <i>Female - Swivel 90° Elbow - Short</i>
 Code 61 Flange	11770 B-61  <i>45° Elbow</i>	11970 B-61  <i>90° Elbow</i>	 Code 62 Flange	16A70 B-61  <i>Flange Head</i>	16N70 B-62  <i>90° Elbow</i>
 Seal-Lok® (O-Ring Face Seal)	1JC70 B-62  <i>Female - Swivel Short</i>	1JS70 B-62  <i>Female - Swivel Long</i>	1J770 B-62  <i>Femal - Swivel 45° Elbow</i>	1J970 B-63  <i>Female - Swivel 90° Elbow - Short</i>	1J570 B-63  <i>Female - Swivel 90° Elbow - Medium</i>
1J170 B-63  <i>Female - Swivel 90° Elbow - Long</i>	 BSP 60° Cone	1GU70 B-64  <i>Female - Swivel</i>	 French Gaz	1FG70 B-64  <i>Male - Rigid</i>	 Metric
10C70 B-65  <i>Female Metric S - Swivel - 45° Elbow</i>	11C70 B-65  <i>Female Metric S - Swivel - 90° Elbow</i>	19270 B-65  <i>Female BSP - Swivel - 60° Cone</i>	1B170 B-65  <i>Female BSP - Swivel - 45° Elbow</i>	1B270 B-66  <i>Female BSP - Swivel - 90° Elbow</i>	1C970 B-66  <i>Female - Swivel</i>
1CA70 B-66  <i>Female Metric L - Swivel - 24° Cone</i>	1CE70 B-66  <i>Female Metric L - Swivel - 45° Elbow</i>	1CF70 B-67  <i>Female Metric L - Swivel - 90° Elbow</i>	1D270 B-67  <i>Male Metric S - Rigid</i>	1D970 B-67  <i>Male - BSP - Rigid</i>	

Hose
A

Fittings 70 Series
B

Equipment
C

Accessories
D

Technical
E

Hose
A

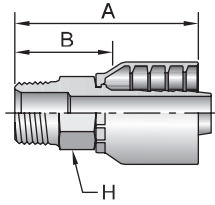

10170 Male NPTF Pipe - Rigid

# Part Number	Thread		Hose I.D.		A		H		B	
	inch		inch		inch	mm	inch	mm	inch	mm
10170-6-6	3/8x18		3/8		2.37	60	3/4		1.47	37
10170-8-8	1/2x14		1/2		2.84	72	7/8		1.40	36

Fittings 70 Series
B

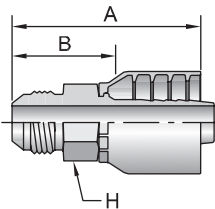

10370 Male JIC 37° - Rigid

# Part Number	Thread		Hose I.D.		A		H		B	
	inch		inch		inch	mm	inch	mm	inch	mm
10370-8-8	1/2	3/4x16	1/2		2.68	68	7/8		1.47	37
10370-10-8	5/8	7/8x14	1/2		2.62	66	15/16		1.41	36

Equipment
C

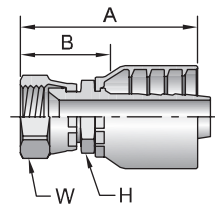

10670 Female JIC 37° - Swivel

# Part Number	Thread		Hose I.D.		A		H	W	B	
	inch		inch		inch	mm	inch	inch	inch	mm
10670-6-6	3/8	9/16x18	3/8		2.29	58	11/16	11/16	1.39	35
10670-8-8	1/2	3/4x16	1/2		2.62	67	13/16	7/8	1.41	36
10670-10-8	5/8	7/8x14	1/2		2.85	72	7/8	1	1.64	42
10670-10-10	5/8	7/8x14	5/8		2.84	72	15/16	1	1.59	40

Accessories
D

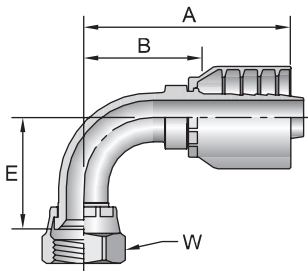

13970 Female JIC 37° - Swivel - 90° Elbow - Short Drop



# Part Number	Thread		Hose I.D.		A		E		W		B	
	inch		inch		inch	mm	inch	mm	inch	mm	inch	mm
13970-8-8	1/2	3/4x16	1/2		2.62	67	1.14	29	7/8		1.41	36

Technical
E

11770

SAE Code 61 Flange Head - 45° Elbow

ISO 12151-3 - 45S - L

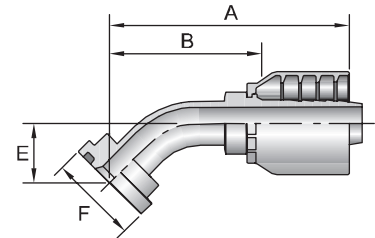

#			A		E			B	
Part Number	Flange inch	Hose I.D. inch	inch	mm	inch	mm	inch	inch	mm
11770-8-8	1/2	1/2	3.28	83	0.77	20	1-3/16	2.07	53
11770-12-10	3/4	5/8	3.37	86	0.76	19	1-1/2	2.12	54



11970

SAE Code 61 Flange Head - 90° Elbow

ISO 12151-3 - E90S - L

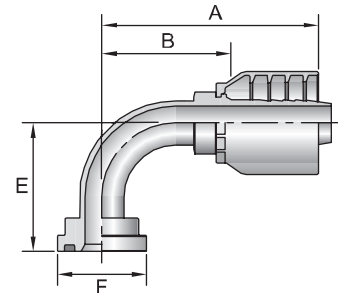

#			A		E			B	
Part Number	Flange inch	Hose I.D. inch	inch	mm	inch	mm	inch	inch	mm
11970-8-8	1/2	1/2	2.93	74	1.60	41	1-3/16	1.72	44
11970-12-10	3/4	5/8	3.54	90	2.02	51	1-1/2	2.29	58



16A70

SAE Code 62 Flange Head

ISO 12151-3 - S - S

#			A			B	
Part Number	Flange inch	Hose I.D. inch	inch	mm	inch	inch	mm
16A70-8-8	1/2	1/2	3.50	88,9	1-1/4	2.29	56,9

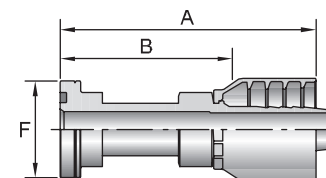

See Accessories for Flange Kits and O-Rings.

Hose
A

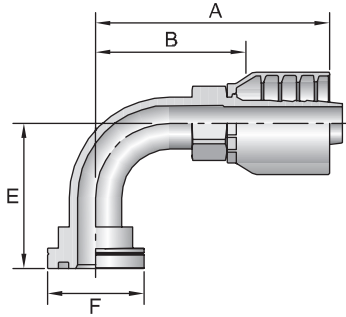

16N70

SAE Code 62 Flange Head - 90° Elbow

ISO 12151-3 - E90S - S (1 Piece: ISO 12151-3 - E90M - S)

# Part Number	Flange inch	Hose I.D. inch	A		E		F		B	
			inch	mm	inch	mm	inch	inch	mm	
16N70-8-8	1/2	1/2	2.60	66	1.61	41	1-1/4	1.34	34	

Fittings 70 Series
B

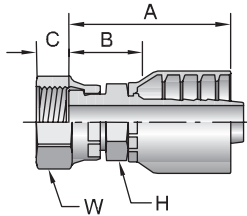

1JC70

Female Seal-Lok® - Swivel - Short

ISO 12151- 1 - SWSA

# Part Number	Thread		Hose I.D. inch	A		C		H	W	B	
	inch	mm		inch	mm	inch	inch	inch	inch	mm	
1JC70-6-6	3/8	11/16x16	3/8	1.94	49	0.34	9	11/16	13/16	1.04	26
1JC70-8-6	1/2	13/16x16	3/8	2.00	51	0.43	11	13/16	15/16	1.10	28
1JC70-8-8	1/2	13/16x16	1/2	2.22	56	0.43	11	13/16	15/16	1.01	26
1JC70-10-10	5/8	1x14	5/8	2.40	61	0.53	13	15/16	1-1/8	1.15	29

Equipment
C

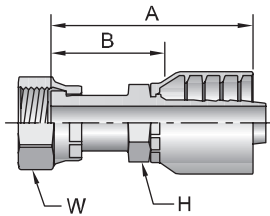

1JS70

Female Seal-Lok® - Swivel - Long

ISO 12151-1 - SWSB

# Part Number	Thread		Hose I.D. inch	A		H	W	B	
	inch	mm		inch	mm	inch	inch	inch	mm
1JS70-6-6	3/8	11/16x16	3/8	2.28	58	11/16	13/16	1.38	35
1JS70-8-8	1/2	13/16x16	1/2	2.65	67	13/16	15/16	1.44	37
1JS70-12-8	3/4	1-3/16x12	1/2	2.90	74	1-1/8	1-3/8	1.69	43
1JS70-12-10	3/4	1-3/16x12	5/8	3.10	79	1-1/8	1-3/8	1.85	47

Accessories
D

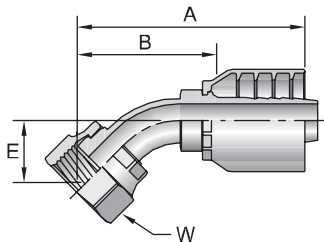

1J770

Female Seal-Lok® - Swivel - 45° Elbow

ISO 12151-1 - SWE45

# Part Number	Thread		Hose I.D. inch	A		E		W	B	
	inch	mm		inch	mm	inch	inch	inch	mm	
1J770-10-10	5/8	1x14	5/8	3.08	78	0.63	16	1-1/8	1.83	46

Technical
E

See Accessories for Flange Kits and O-Rings.

1J970

Female Seal-Lok® - Swivel - 90° Elbow - Short Drop
ISO 12151-1 - SWES90

# Part Number	Thread		Hose I.D. inch	A		E		W inch	B	
	inch	mm		inch	mm	inch	mm		inch	mm
1J970-8-8	1/2	13/16x16	1/2	2.59	66	1.14	29	15/16	1.38	35
1J970-12-8	3/4	1-3/16x12	1/2	3.21	82	1.88	48	1-3/8	2.00	51

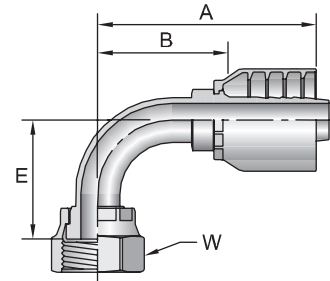

1J570

Female Seal-Lok® - Swivel - 90° Elbow - Medium Drop
ISO 12151-1 - SWSB

# Part Number	Thread		Hose I.D. inch	A		E		W inch	B	
	inch	mm		inch	mm	inch	mm		inch	mm
1J570-10-10	5/8	1x14	5/8	2.88	73	1.85	47	1-1/8	1.63	41

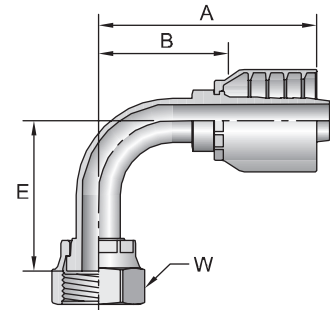

1J170

Female Seal-Lok® - Swivel - 90° Elbow - Long Drop
ISO 12151-1 - SWEL90

# Part Number	Thread		Hose I.D. inch	A		E		W inch	B	
	inch	mm		inch	mm	inch	mm		inch	mm
1J170-8-8	1/2	13/16x16	1/2	2.59	66	2.52	65	15/16	1.38	35
1J170-10-10	5/8	1x14	5/8	2.88	73	2.76	70	1-1/8	1.63	41

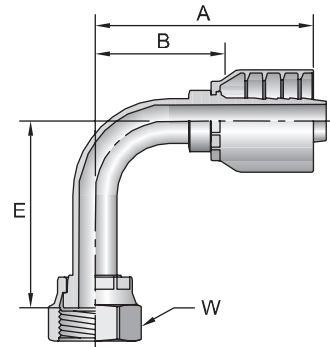



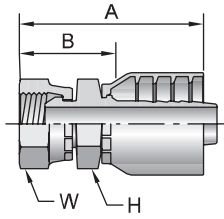

See Accessories for Flange Kits and O-Rings.

Hose
A



1GU70

Female BSP Parallel Pipe - Swivel - (60° Cone)

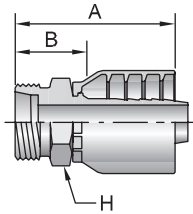

#			A				B	
Part Number	Thread Inch	Hose I.D. inch	inch	mm	H mm	W inch	inch	mm
1GU70-6-6	3/8x19	3/8	2.45	62	22	NA	1.55	39
1GU70-8-8	1/2x14	1/2	2.82	72	27	NA	1.61	41

Fittings 70 Series
B



1FG70

Male French Gaz Series - Rigid - (24° Cone)

#			A				B	
Part Number	Thread mm	Hose I.D. inch	inch	mm	inch	mm	inch	mm
1FG70-21-10	21 M30x1,5	5/8	2.87	73	1.18	30	1.62	41

Equipment
C

Accessories
D

Technical
E

10C70

Female Metric S - Swivel - 45° Elbow - (24° Cone with O-Ring)
ISO 12151-2 - SWE45

# Part Number	Thread mm	Hose I.D. inch	A		E		W mm	B	
			inch	mm	inch	mm		inch	mm
10C70-12-6	12 M20x1,5	3/8	2.72	69	0.79	20	24	1.57	40
10C70-16-8	16 M24x1,5	1/2	3.27	83	0.94	24	30	1.89	48
10C70-20-10	20 M30x2	5/8	3.58	91	0.98	25	36	2.05	52

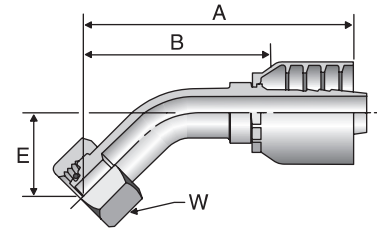

11C70

Female Metric S - Swivel - 90° Elbow - (24° Cone with O-Ring)
ISO 12151-2 - SWE

# Part Number	Thread mm	Hose I.D. inch	A		E		W mm	B	
			inch	mm	inch	mm		inch	mm
11C70-12-6	12 M20X1,5	3/8	2.64	67	1.46	37	24	1.50	38
11C70-20-10	20 M30X2	5/8	3.11	79	1.89	48	36	1.57	40

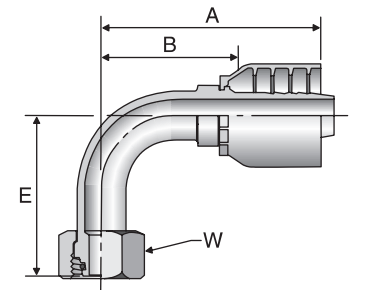

19270

Female BSP Parallel Pipe - Swivel - (60° Cone)
ISO 228-1

# Part Number	Thread inch	Hose I.D. inch	A		C		W mm	B	
			inch	mm	inch	mm		inch	mm
19270-6-6	3/8x19	3/8	1.93	49	0.28	7	22	0.79	20
19270-8-8	1/2x14	1/2	2.24	57	0.28	7	27	0.87	22
19270-10-10	5/8x14	5/8	2.24	57	0.35	9	30	0.83	21
19270-12-10	3/4x14	5/8	2.40	61	0.35	9	32	0.87	22

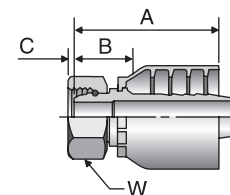

1B170

Female BSP Parallel pipe - Swivel- 45° Elbow - (60° Cone)
ISO 228-1

# Part Number	Thread inch	Hose I.D. inch	A		E		W mm	B	
			inch	mm	inch	mm		inch	mm
1B170-8-8	1/2x14	1/2	3.11	79	0.79	20	27	1.77	45

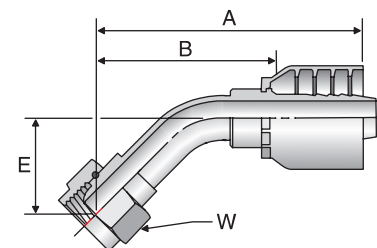

Hose
A

Fittings 70 Series
B

Equipment
C

Accessories
D

Technical
E

Hose
A

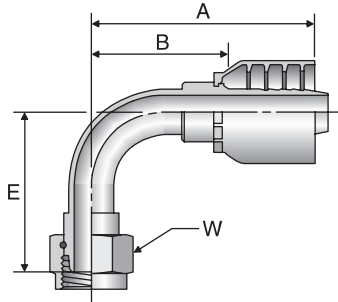

1B270

Female BSP Parallel Pipe - Swivel - 90° Elbow - (60° Cone)
ISO 228-1

# Part Number	Thread inch	Hose I.D. inch	A		E		W mm	B	
			inch	mm	inch	mm		inch	mm
1B270-8-8	1/2x14	1/2	2.76	70	1.54	39	27	1.38	35
1B270-10-10	5/8x14	5/8	3.07	78	1.81	46	30	1.61	41
1B270-12-10	3/4x14	5/8	3.19	81	1.65	42	32	1.61	41

Fittings 70 Series
B

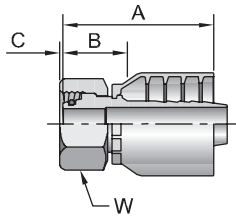

1C970

Female Metric S - Swivel - (24° Cone with O-Ring)

# Part Number	Thread mm		Hose I.D. inch	A		C		W mm	B	
	mm	mm		inch	mm	inch	mm		inch	mm
1C970-12-6	12	M20x1,5	3/8	2.03	52	0.03	1	24	1.13	29
1C970-16-8	16	M24x1,5	1/2	2.31	59	0.09	2	30	1.10	28
1C970-20-10	20	M30x2	5/8	2.51	64	0.05	1	36	1.26	32

When measuring overall length to end of nut, B + C dimensions must be used to calculate cut-off allowance.

Equipment
C

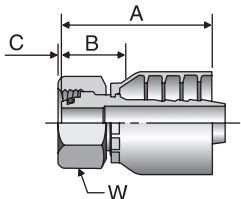

1CA70

Female Metric L - Swivel - (24° Cone with O-Ring)
ISO 12151-2 - SWS

# Part Number	Thread mm		Hose I.D. inch	A		C		W mm	B	
	mm	mm		inch	mm	inch	mm		inch	mm
1CA70-12-6	12	M18x1,5	3/8	2.09	53	0.04	1	22	0.94	24
1CA70-15-8	15	M22x1,5	1/2	2.09	62	0.07	2	22	0.94	27
1CA70-18-10	18	M26x1,5	5/8	2.44	62	0.02	0.5	32	1.02	26

Accessories
D

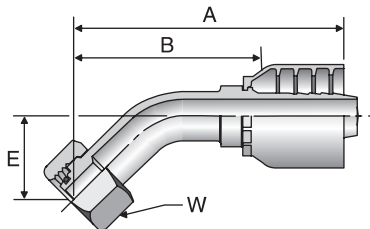

1CE70

Female Metric L - Swivel - 45° Elbow - (24° Cone with O-Ring)
ISO 12151-2 - SWE45

# Part Number	Thread mm		Hose I.D. inch	A		E		W mm	B	
	mm	mm		inch	mm	inch	mm		inch	mm
1CE70-18-10	18	M26x1,5	5/8	3.58	91	0.98	25	32	2.05	52

Technical
E

1CF70

Female Metric L - Swivel - 90° Elbow - (24° Cone with O-Ring)

ISO 12151-2 - SWE

# Part Number	Thread mm	Hose I.D. inch	A		E		W mm	B	
			inch	mm	inch	mm		inch	mm
1CF70-15-8	15 M22x1,5	1/2	2.91	74	1.77	45	27	1.54	39
1CF70-18-10	18 M26x1,5	5/8	3.11	79	1.93	49	32	1.65	42

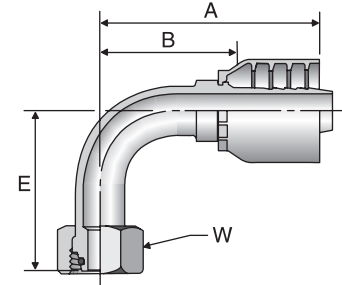

1D270

Male Metric S - Rigid - (24° Cone)

ISO 8434-1

# Part Number	Thread mm	Hose I.D. inch	A		H mm	B	
			inch	mm		inch	mm
1D270-16-8	16 M24x1,5	1/2	2.44	62	24	1.10	28
1D270-20-10	20 M30x2	5/8	2.95	75	30	1.26	32

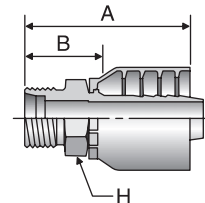

1D970

Male BSP Parallel Pipe - Rigid - (60° Cone)

ISO 228-1

# Part Number	Thread inch	Hose I.D. inch	A		H mm	B	
			inch	mm		inch	mm
1D970-8-8	1/2x14	1/2	2.44	62	27	1.10	28

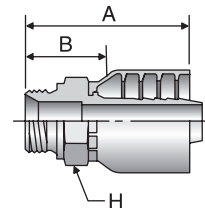

Hose
A

Fittings 70 Series
B

Equipment
C

Accessories
D

Technical
E











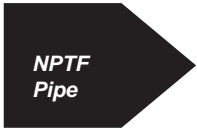
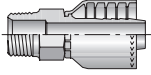

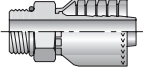

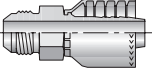
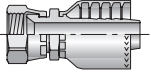
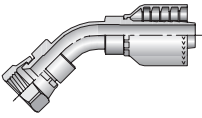
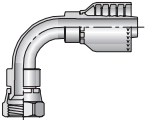
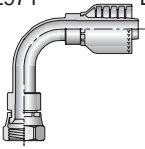
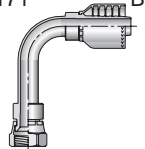

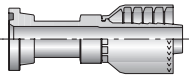
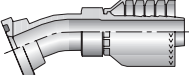
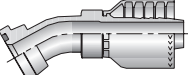
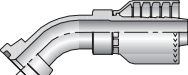
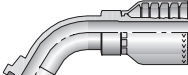
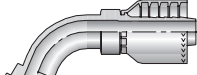
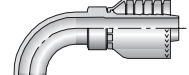
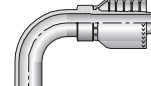
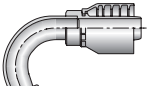
Hose
A

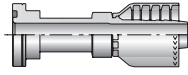
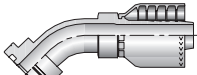
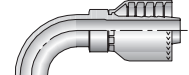
Fittings 70 Series
B

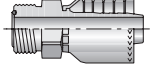
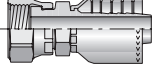
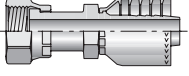
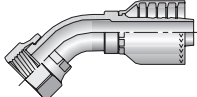
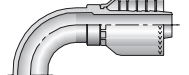
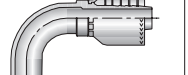
Equipment
C

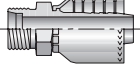
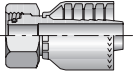
Accessories
D

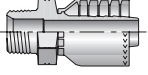
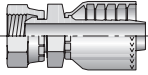
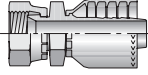
Technical
E

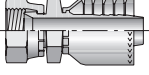
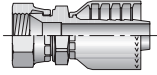
 NPTF Pipe	10171 B-70  <i>Male - Rigid</i>	 SAE	10571 B-70  <i>Male - Rigid</i>	 JIC	10371 B-70  <i>Male - Rigid</i>
10671 B-71  <i>Female - Swivel</i>	13771 B-71  <i>Female - Swivel 45° Elbow - Short</i>	13971 B-72  <i>Female - Swivel 90° Elbow - Short</i>	1L971 B-72  <i>Female - Swivel 90° Elbow - Medium</i>	14171 B-72  <i>Female - Swivel 90° Elbow - Long</i>	 Flange Code 61
11571 B-73  <i>Flange</i>	11671 B-73  <i>22-1/2° Elbow</i>	12671 B-74  <i>30° Elbow</i>	11771 B-74  <i>45° Elbow</i>	12771 B-74  <i>60° Elbow</i>	11871 B-75  <i>67-1/2° Elbow</i>
11971 B-75  <i>90° Elbow</i>	18971 B-76  <i>90° Elbow-Long</i>	12U71 B-76  <i>110° Elbow</i>	 Flange Code 62	16A71 B-76  <i>Flange</i>	16F71 B-76  <i>45° Elbow</i>
16N71 B-77  <i>90° Elbow</i>	 Seal-Lok® (O-Ring Face Seal)	1J071 B-77  <i>Male - Rigid</i>	1JC71 B-77  <i>Female - Swivel Short</i>	1JS71 B-78  <i>Female - Swivel Long</i>	1J771 B-78  <i>Female - Swivel 45° Elbow</i>
1J971 B-79  <i>Female - Swivel 90° Elbow - Short</i>	1J571 B-79  <i>Female - Swivel 90° Elbow - Medium</i>	1J171 B-79  <i>Female - Swivel 90° Elbow - Long</i>	 Metric "S"	1D271 B-80  <i>Male - Rigid</i>	1C971 B-80  <i>Female - Swivel</i>
 BSP	1UT71 B-80  <i>Male - Rigid</i>	1GU71 B-80  <i>Female - Swivel</i>	1FU71 B-81  <i>Female - Swivel</i>	 Metric	1MU71 B-81  <i>Female - Swivel</i>
1XU71 B-81  <i>Female - Swivel</i>					

Hose
A

Fittings 71 Series
B

Equipment
C

Accessories
D

Technical
E

Hose
A

Fittings 71 Series
B

Equipment
C

Accessories
D

Technical
E

10171 Male NPTF Pipe - Rigid

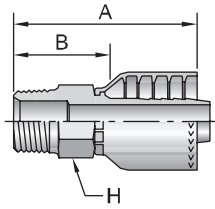

# Part Number	Thread		Hose I.D.		A		B	
	inch	inch	inch	mm	inch	inch	mm	
10171-6-6	3/8x18	3/8	2.36	60	3/4	1.47	37	
10171-8-8	1/2x14	1/2	2.82	72	7/8	1.63	41	
10171-12-8	3/4x14	1/2	2.67	68	1-1/16	1.47	37	
10171-12-12	3/4x14	3/4	3.08	78	1-1/16	1.71	43	
10171-16-12	1x11-1/2	3/4	3.08	78	1-3/8	1.72	44	
10171-16-16	1x11-1/2	1	3.63	92	1-3/8	2.04	52	
10171-20-16	1-1/4x11-1/2	1	3.49	89	1-11/16	1.90	48	
10171-20-20	1-1/4x11-1/2	1-1/4	4.06	103	1-3/4	2.39	61	
10171-24-20	1-1/2x11-1/2	1-1/4	3.77	96	2	2.10	53	
10171-24-24	1-1/2x11-1/2	1-1/2	4.32	110	2	2.19	56	
10171-32-32	2x11-1/2	2	4.66	118	2-1/2	2.52	64	

10571 Male SAE Straight Thread with O-Ring - Rigid

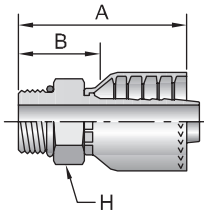

# Part Number	Thread		Hose I.D.		A		B	
	inch	inch	inch	mm	inch	inch	mm	
10571-8-8	1/2	3/4x16	1/2	2.44	62	7/8	1.25	32
10571-12-12	3/4	1-1/16x12	3/4	2.79	71	1-1/4	1.43	36
10571-16-16	1	1-5/16x12	1	3.42	87	1-1/2	1.77	45
10571-20-20	1-1/4	1-5/8x12	1-1/4	3.67	93	1-7/8	2.00	51

10371 Male JIC 37° - Rigid

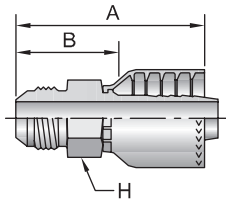

# Part Number	Thread		Hose I.D.		A		B	
	inch	inch	inch	mm	inch	inch	mm	
10371-6-6	3/8	9/16x18	3/8	2.44	62	3/4	1.55	39
10371-8-6	1/2	3/4x16	3/8	2.29	58	7/8	1.40	36
10371-8-8	1/2	3/4x16	1/2	2.66	68	7/8	1.41	36
10371-10-8	5/8	7/8x14	1/2	2.60	66	15/16	1.41	36
10371-10-10	5/8	7/8x14	5/8	2.93	74	15/16	1.69	43
10371-12-12	3/4	1-1/16x12	3/4	3.17	80	1-1/8	1.81	46
10371-14-12	7/8	1-3/16x12	3/4	3.09	78	1-1/4	1.73	44
10371-16-12	1	1-5/16x12	3/4	3.02	77	1-3/8	1.66	42
10371-16-16	1	1-5/16x12	1	3.68	93	1-3/8	2.03	52
10371-20-16	1-1/4	1-5/8x12	1	3.43	87	1-7/8	1.84	47
10371-20-20	1-1/4	1-5/8x12	1-1/4	3.94	100	1-7/8	2.27	58

10671

Female JIC 37° - Swivel

# Part Number	Thread		Hose I.D. inch	A		H inch	W inch	B		Additional Material Stainless Steel (C)
	inch	9/16x18		inch	mm			inch	mm	
10671-6-6	3/8	9/16x18	3/8	2.28	58	11/16	11/16	1.39	35	
10671-8-6	1/2	3/4x16	3/8	2.47	63	11/16	7/8	1.58	40	
10671-8-8	1/2	3/4x16	1/2	2.61	66	13/16	7/8	1.41	36	•
10671-10-8	5/8	7/8x14	1/2	2.84	72	7/8	1	1.64	42	
10671-10-10	5/8	7/8x14	5/8	2.83	72	15/16	1	1.58	40	
10671-10-12	5/8	7/8x14	3/4	2.92	74	1-1/16	1	1.54	39	
10671-12-8	3/4	1-1/16x12	1/2	2.75	70	1-1/16	1-1/4	1.58	40	
10671-12-10	3/4	1-1/16x12	5/8	3.00	76	1-1/16	1-1/4	1.75	44	
10671-12-12	3/4	1-1/16x12	3/4	2.96	75	1-1/16	1-1/4	1.60	41	•
10671-12-16	3/4	1-1/16x12	1	3.37	86	1-3/8	1-1/4	1.67	42	
10671-14-12	7/8	1-3/16x12	3/4	3.01	76	1-1/4	1-3/8	1.61	41	
10671-16-12	1	1-5/16x12	3/4	3.28	83	1-1/4	1-1/2	1.92	49	
10671-16-16	1	1-5/16x12	1	3.60	91	1-3/8	1-1/2	2.01	51	•
10671-20-16	1-1/4	1-5/8x12	1	3.80	97	1-5/8	2	2.21	56	
10671-20-20	1-1/4	1-5/8x12	1-1/4	3.92	100	1-7/8	2	2.25	57	•
10671-24-20 [^]	1-1/2	1-7/8x12	1-1/4	4.10	104	2-1/8	2-1/4	2.43	62	
10671-24-24	1-1/2	1-7/8x12	1-1/2	4.69	119	2-1/8	2-1/4	2.50	64	•
10671-32-32	2	2-1/2x12	2	5.39	137	2-1/2	2-7/8	3.19	81	

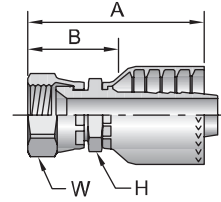

13771

Female JIC 37° - Swivel - 45° Elbow - Short Drop

# Part Number	Thread		Hose I.D. inch	A		E		W inch	B	
	inch	9/16x18		inch	mm	inch	mm		inch	mm
13771-6-6	3/8	9/16x18	3/8	2.34	59	0.43	11	11/16	1.44	37
13771-8-8	1/2	3/4x16	1/2	2.83	72	0.59	15	7/8	1.62	41
13771-10-8	5/8	7/8x14	1/2	2.93	74	0.63	16	1	1.72	44
13771-10-10	5/8	7/8x14	5/8	3.08	78	0.63	16	1	1.83	46
13771-12-12	3/4	1-1/16x12	3/4	3.64	92	0.83	21	1-1/4	2.26	57
13771-16-16	1	1-5/16x12	1	4.20	107	0.90	23	1-1/2	2.61	66
13771-20-20	1-1/4	1-5/8x12	1-1/4	5.22	133	1.69	43	2	3.53	90

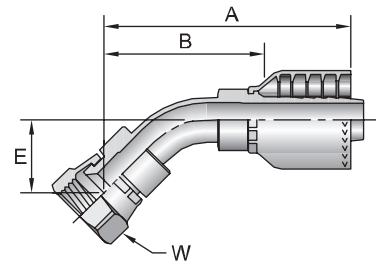

Stainless steel fittings must be assembled with Karrykrimp 2, PHastkrimp, Superkrimp or Parkrimp 2. See CrimpSource for more information.

[^] Must be assembled with Die Part No. 83C-D16H in a Superkrimp or Parkrimp 2.

^{^^} Must be assembled with Die Part No. 83C-D20H in a Superkrimp or Parkrimp 2.

Hose
A

Fittings 71 Series
B

Equipment
C

Accessories
D

Technical
E

13971

Female JIC 37° - Swivel - 90° Elbow - Short Drop

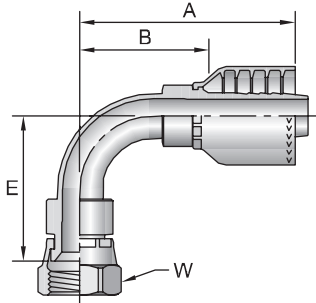

# Part Number	Thread		Hose I.D. inch	A		E		W		B	
	inch	mm		inch	mm	inch	mm	inch	mm	inch	mm
13971-6-6	3/8	9/16x18	3/8	2.21	56	0.91	23	11/16	1.31	33	
13971-8-8	1/2	3/4x16	1/2	2.62	67	1.14	29	7/8	1.41	36	
13971-10-8	5/8	7/8x14	1/2	2.74	70	1.26	32	1	1.53	39	
13971-10-10	5/8	7/8x14	5/8	2.88	73	1.26	32	1	1.63	41	
13971-12-10	3/4	1-1/16x12	5/8	2.98	76	1.89	48	1-1/4	1.73	44	
13971-12-12	3/4	1-1/16x12	3/4	3.50	89	1.89	48	1-1/4	2.11	54	
13971-16-16	1	1-5/16x12	1	4.36	111	2.20	56	1-1/2	2.58	66	
13971-20-20	1-1/4	1-5/8x12	1-1/4	4.78	121	3.33	85	2	3.11	79	
13971-24-24	1-1/2	1-7/8x12	1-1/2	6.33	161	3.98	101	2-1/4	4.14	105	

1L971

Female JIC 37° - Swivel - 90° Elbow - Medium Drop

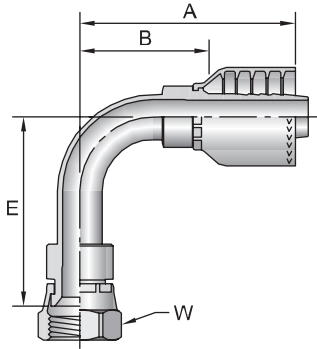

# Part Number	Thread		Hose I.D. inch	A		E		W		B	
	inch	mm		inch	mm	inch	mm	inch	mm	inch	mm
1L971-10-8	5/8	7/8x14	1/2	3.24	82	1.75	44	1	2.04	52	

14171

Female JIC 37° - Swivel - 90° Elbow - Long Drop

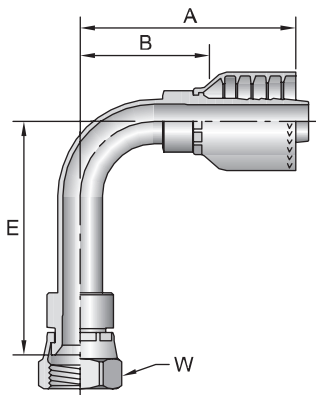

# Part Number	Thread		Hose I.D. inch	A		E		W		B	
	inch	mm		inch	mm	inch	mm	inch	mm	inch	mm
14171-6-6	3/8	9/16x18	3/8	2.34	59	2.13	54	11/16	1.44	37	
14171-8-8	1/2	3/4x16	1/2	2.58	66	2.52	64	7/8	1.37	35	
14171-12-12	3/4	1-1/16x14	3/4	3.49	89	3.78	96	1-1/4	2.11	54	
14171-16-16	1	1-5/16x12	1	4.36	111	4.32	110	1-1/2	2.58	66	

11571

SAE Code 61 Flange Head
ISO 12151-3 - S - L

# Part Number	Flange inch	Hose I.D. inch	A		F inch	B	
			inch	mm		inch	mm
11571-8-8	1/2	1/2	3.48	88	1-3/16	2.27	58
11571-10-10	5/8	5/8	3.69	93,7	1-11/32	2.44	62,0
11571-12-8	3/4	1/2	2.46	62,5	1-1/2	1.26	32,0
11571-12-12	3/4	3/4	3.86	98	1-1/2	2.48	63
11571-16-12	1	3/4	2.74	70	1-3/4	1.36	35
11571-16-16	1	1	4.32	110	1-3/4	2.55	65
11571-20-12	1-1/4	3/4	3.90	99	2	2.54	65
11571-20-16	1-1/4	1	3.27	83	2	1.58	40
11571-20-20	1-1/4	1-1/4	4.70	119	2	3.01	76
11571-20-24	1-1/4	1-1/2	5.41	137	2	3.22	82
11571-24-16 [^]	1-1/2	1	3.41	86,6	2-3/8	1.63	41,4
11571-24-20 ^{^^}	1-1/2	1-1/4	4.08	104	2-3/8	2.39	61
11571-24-24	1-1/2	1-1/2	5.46	139	2-3/8	3.27	83
11571-24-32	1-1/2	2	5.65	144	2-3/8	3.45	88
11571-32-20 ^{^^}	2	1-1/4	4.29	109,0	2-13/16	2.60	66,0
11571-32-24	2	1-1/2	4.01	102	2-13/16	1.82	46
11571-32-32	2	2	5.65	144	2-13/16	3.45	88
11571-40-32	2-1/2	2	4.51	115	3-5/16	2.31	59

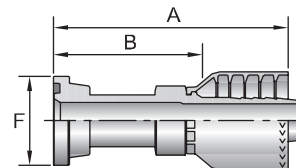

11671

SAE Code 61 Flange Head - 22-1/2° Elbow
ISO 12151-3 - E22M - L

# Part Number	Flange inch	Hose I.D. inch	A		E		F inch	B	
			inch	mm	inch	mm		inch	mm
11671-12-12	3/4	3/4	3.90	99	0.44	11	1-1/2	2.54	65
11671-16-12	1	3/4	3.89	99	0.44	11	1-3/4	2.53	64
11671-16-16	1	1	4.26	108	0.44	11	1-3/4	2.67	68
11671-20-16	1-1/4	1	4.36	111	0.47	12	2	2.77	70
11671-20-20	1-1/4	1-1/4	4.67	119	0.50	13	2	3.00	76
11671-24-20 ^{^^}	1-1/2	1-1/4	4.68	119	0.53	13	2-3/8	3.01	76
11671-24-24	1-1/2	1-1/2	5.88	149	0.63	16	2-3/8	3.69	94
11671-32-32	2	2	7.37	187	0.88	22	2-13/16	5.22	133

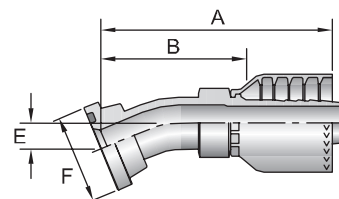

[^] Must be assembled with Die Part No. 83C-D16H in a Superkrimp or Parkrimp 2.
^{^^} Must be assembled with Die Part No. 83C-D20H in a Superkrimp or Parkrimp 2.
See Accessories for Flange Kits and O-Rings.

Hose
A

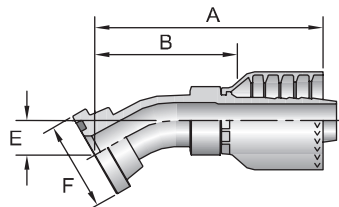

12671

SAE Code 61 Flange Head - 30° Elbow

ISO 12151-3 - E30S - L (1 Piece: ISO 12151-3 - E30M - L)

# Part Number	Flange inch	Hose I.D. inch	A		E		F inch	B	
			inch	mm	inch	mm		inch	mm
12671-12-12	3/4	3/4	3.90	99	0.59	15	1-1/2	2.52	64
12671-16-16	1	1	4.46	113	0.62	16	1-3/4	2.68	68
12671-20-16	1-1/4	1	4.46	113	0.62	16	2	2.68	68
12671-20-20	1-1/4	1-1/4	4.87	124	0.72	18	2	3.18	81
12671-24-24	1-1/2	1-1/2	6.01	153	0.88	22	2-3/8	3.82	97
12671-32-24	2	1-1/2	6.01	153	0.88	22	2-13/16	3.82	97
12671-32-32	2	2	7.60	193	1.25	32	2-13/16	5.40	137

Fittings 71 Series
B

11771

SAE Code 61 Flange Head - 45° Elbow

ISO 12151-3 - E45S - L (1 Piece: ISO 12151-3 - E45M - L)

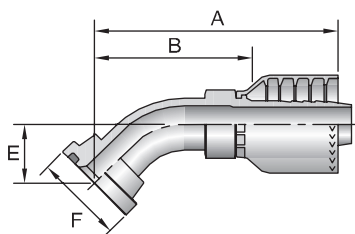

# Part Number	Flange inch	Hose I.D. inch	A		E		F inch	B	
			inch	mm	inch	mm		inch	mm
11771-10-10	5/8	5/8	4.54	115	0.94	24	1-11/32	3.29	84
11771-12-8	3/4	1/2	3.27	83	0.84	21	1-1/2	2.07	53
11771-12-10	3/4	5/8	3.94	100	0.76	19	1-1/2	2.70	69
11771-12-12	3/4	3/4	3.85	98	1.02	26	1-1/2	2.47	63
11771-16-12	1	3/4	3.85	98	1.02	26	1-3/4	2.47	63
11771-16-16	1	1	4.84	123	1.26	32	1-3/4	3.06	78
11771-20-16	1-1/4	1	4.84	123	1.02	26	2	3.06	78
11771-20-20 [^]	1-1/4	1-1/4	5.61	142	1.50	38	2	3.92	100
11771-20-24	1-1/4	1-1/2	6.22	158	1.12	28	2	4.03	102
11771-24-20 [^]	1-1/2	1-1/4	5.55	141	1.50	38	2-3/8	3.86	98
11771-24-24	1-1/2	1-1/2	6.22	158	1.41	36	2-3/8	4.03	102
11771-32-24	2	1-1/2	6.19	157	1.41	36	2-13/16	4.00	102
11771-32-32	2	2	7.94	202	2.03	52	2-13/16	5.74	146
11771-40-32	2-1/2	2	7.83	199	2.03	52	3-5/16	5.62	143

Equipment
C

12771

SAE Code 61 Flange Head - 60° Elbow

ISO 12151-3 - E60S - L (1 Piece: ISO 12151-3 - E60M - L)

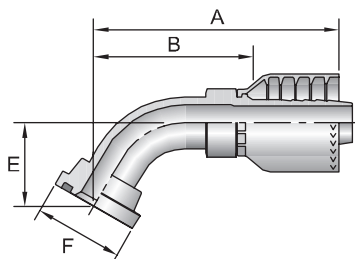

# Part Number	Flange inch	Hose I.D. inch	A		E		F inch	B	
			inch	mm	inch	mm		inch	mm
12771-12-12	3/4	3/4	4.16	106	1.43	36	1-1/2	2.78	71
12771-16-12	1	3/4	4.15	105	1.39	35	1-3/4	2.77	70
12771-16-16	1	1	4.74	120	1.49	38	1-3/4	3.36	85
12771-20-20	1-1/4	1-1/4	5.10	130	1.69	43	2	3.41	87
12771-24-20 [^]	1-1/2	1-1/4	5.12	130	1.70	43	2-3/8	3.43	87
12771-24-24	1-1/2	1-1/2	6.25	159	2.03	52	2-3/8	4.06	103
12771-32-32	2	2	7.93	201	2.88	73	2-13/16	5.73	146

Accessories
D

Technical
E

[^] Must be assembled with Die Part No. 83C-D16H in a Superkrimp or Parkrimp 2.

[^] Must be assembled with Die Part No. 83C-D20H in a Superkrimp or Parkrimp 2.

See Accessories for Flange Kits and O-Rings.

11871

SAE Code 61 Flange Head - 67-1/2° Elbow

ISO 12151-3 - E67S - L (1 Piece: ISO 12151-3 - E67M - L)

# Part Number	Flange inch	Hose I.D. inch	A		E		F inch	B	
			inch	mm	inch	mm		inch	mm
11871-12-12	3/4	3/4	4.12	105	1.62	41	1-1/2	2.74	70
11871-16-12	1	3/4	4.11	104	1.59	40	1-3/4	2.73	69
11871-16-16	1	1	4.76	121	1.75	44	1-3/4	2.98	76
11871-20-20	1-1/4	1-1/4	5.08	129	1.94	49	2	3.39	86
11871-24-20 ^{^^}	1-1/2	1-1/4	5.07	129	1.95	50	2-3/8	3.38	86
11871-24-24	1-1/2	1-1/2	6.20	157	2.31	59	2-3/8	4.01	102
11871-32-24	2	1-1/2	6.20	157	2.31	59	2-13/16	4.01	102
11871-32-32	2	2	7.89	200	3.31	84	2-13/16	5.69	145

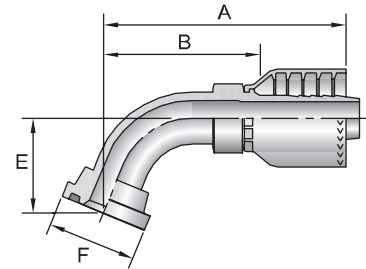

11971

SAE Code 61 Flange Head - 90° Elbow

ISO 12151-3 - E90S - L (1 Piece: ISO 12151-3 - E90M - L)

# Part Number	Flange inch	Hose I.D. inch	A		E		F inch	B	
			inch	mm	inch	mm		inch	mm
11971-8-8	1/2	1/2	2.93	74	1.6	41	1-3/16	1.72	44
11971-10-10	5/8	5/8	3.62	92	2.10	53	1-11/32	2.37	60
11971-12-8	3/4	1/2	2.93	74	1.66	42	1-1/2	1.72	44
11971-12-10	3/4	5/8	3.62	92	2.10	53	1-1/2	2.37	60
11971-12-12	3/4	3/4	3.48	88	2.28	58	1-1/2	2.10	53
11971-16-12	1	3/4	3.52	89	2.28	58	1-3/4	2.14	54
11971-16-16	1	1	4.36	111	2.76	70	1-3/4	2.58	66
11971-16-20	1	1-1/4	4.53	115	2.39	61	1-3/4	2.75	70
11971-20-12	1-1/4	3/4	3.81	97	2.13	54	2	2.45	62
11971-20-16	1-1/4	1	4.33	110	2.76	70	2	2.55	65
11971-20-20	1-1/4	1-1/4	5.12	130	3.54	90	2	3.43	87
11971-20-24	1-1/4	1-1/2	6.33	161	3.00	76	2	4.14	105
11971-24-16 [^]	1-1/2	1	4.53	115	2.39	61	2-3/8	2.75	70
11971-24-20 ^{^^}	1-1/2	1-1/4	5.09	129	3.54	90	2-3/8	3.40	86
11971-24-24	1-1/2	1-1/2	6.34	161	4.09	104	2-3/8	4.15	105
11971-32-24	2	1-1/2	5.84	148	3.12	79	2-13/16	3.65	93
11971-32-32	2	2	7.75	197	5.43	138	2-13/16	5.55	141
11971-40-32	2-1/2	2	7.43	189	4.5	114	3-5/16	5.23	133

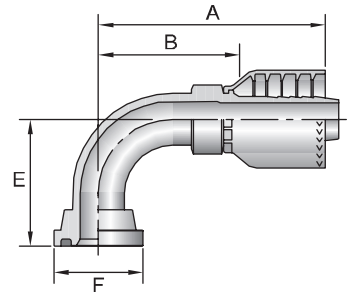

[^] Must be assembled with Die Part No. 83C-D16H in a Superkrimp or Parkrimp 2.

^{^^} Must be assembled with Die Part No. 83C-D20H in a Superkrimp or Parkrimp 2.

See Accessories for Flange Kits and O-Rings.

Hose
A

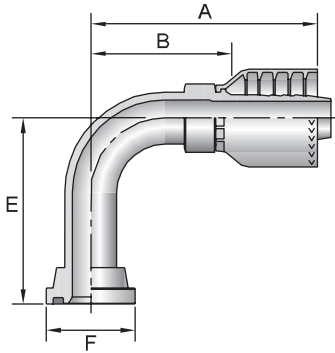

18971

SAE Code 61 Flange Head - 90° Elbow - Long Drop

#			A		E			B	
Part Number	Flange inch	Hose I.D. inch	inch	mm	inch	mm	inch	inch	mm
18971-12-12	3/4	3/4	3.49	89	3.03	77	1-1/2	2.11	54
18971-16-16	1	1	4.52	115	4.60	117	1-3/4	2.74	70
18971-20-16	1-1/4	1	4.53	115	4.60	117	2	2.75	70

Fittings 71 Series
B

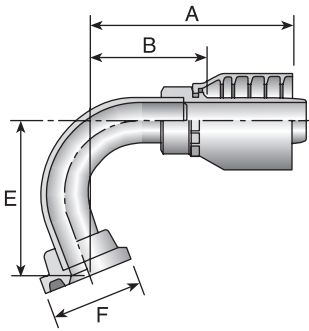

12U71

SAE Code 61 Flange Head - 110° Elbow

#			A		E			B	
Part Number	Flange inch	Hose I.D. inch	inch	mm	inch	mm	inch	inch	mm
12U71-16-16	1	1	4.49	114	3.69	94	1-3/4	2.71	69

Equipment
C

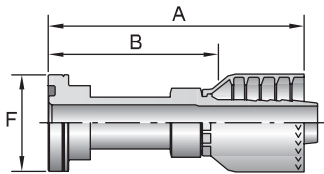

16A71

SAE Code 62 Flange Head ISO 12151-3 - S - S

#			A			B	
Part Number	Flange inch	Hose I.D. inch	inch	mm	inch	inch	mm
16A71-12-12	3/4	3/4	4.31	109	1-5/8	2.93	74
16A71-16-12	1	3/4	3.10	78,7	1-7/8	1.72	43,7
16A71-16-16	1	1	4.89	124	1-7/8	3.11	79
16A71-20-16	1-1/4	1	3.69	93,7	2-1/8	1.91	48,5
16A71-20-20	1-1/4	1-1/4	5.01	127,3	2-1/8	3.32	84,3
16A71-24-24	1-1/2	1-1/2	6.34	161,0	2-1/2	4.15	105,4
16A71-32-32	2	2	7.16	182	3-1/8	4.96	126

Accessories
D

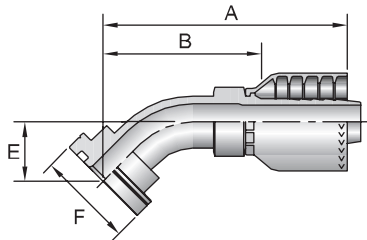

16F71

SAE Code 62 Flange Head - 45° Elbow ISO 12151-3 - E45S - L (1 Piece: ISO 12151-3 - E45M - S)

#			A		E			B	
Part Number	Flange inch	Hose I.D. inch	inch	mm	inch	mm	inch	inch	mm
16F71-12-12	3/4	3/4	3.82	97	1.03	26	1-5/8	2.44	62
16F71-16-16	1	1	4.74	120,3	1.26	32	1-7/8	2.96	75,2
16F71-20-16	1-1/4	1	4.61	117	1.06	27	2-1/8	3.02	77
16F71-20-20	1-1/4	1-1/4	5.07	129	1.19	30	2-1/8	3.38	86
16F71-24-24	1-1/2	1-1/2	6.21	158	1.44	37	2-1/2	4.02	102
16F71-32-32	2	2	7.87	200	2.05	52	3-1/8	5.67	144

Technical
E

See Accessories for Flange Kits and O-Rings.

16N71

SAE Code 62 Flange Head - 90° Elbow

ISO 12151-3 - E90S - L (1 Piece: ISO 12151-3 - E90M - S)

# Part Number	Flange inch	Hose I.D. inch	A		E		F		B	
			inch	mm	inch	mm	inch	inch	mm	
16N71-12-12	3/4	3/4	3.51	89	2.28	58	1-5/8	2.13	54	
16N71-16-12	1	3/4	3.49	89	2.29	58	1-7/8	2.11	54	
16N71-16-16	1	1	4.36	111	2.76	70	1-7/8	2.58	66	
16N71-20-16	1-1/4	1	4.36	111	2.76	70	2-1/8	2.58	66	
16N71-20-20	1-1/4	1-1/4	5.09	129	3.54	90	2-1/8	3.40	86	
16N71-24-24	1-1/2	1-1/2	5.85	149	3.12	79	2-1/2	3.66	93	
16N71-32-32	2	2	7.73	196	4.50	114	3-1/8	5.53	140	

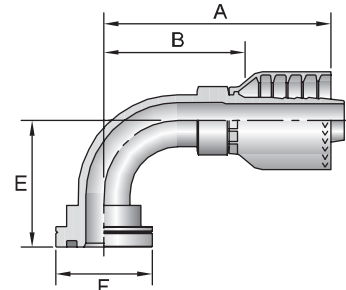

1J071

Male Seal-Lok® - Rigid - (with O-Ring)

ISO 12151-1 - S

# Part Number	Thread inch		Hose I.D. inch	A		H inch	B	
	inch	inch		inch	mm		inch	mm
1J071-8-8	1/2	13/16x16	1/2	2.40	61	7/8	1.20	30
1J071-10-8	5/8	1x14	1/2	2.61	66	1-1/16	1.41	36
1J071-10-10	5/8	1x14	5/8	2.69	68	1-1/16	1.44	37
1J071-12-10	3/4	1-3/16x12	5/8	2.79	71	1-1/4	1.55	39
1J071-12-12	3/4	1-3/16x12	3/4	2.87	73	1-1/4	1.51	38
1J071-16-12	1	1-7/16x12	3/4	2.91	74	1-1/2	1.53	39
1J071-16-16	1	1-7/16x12	1	3.27	83	1-1/2	1.68	43
1J071-20-20	1-1/4	1-11/16x12	1-1/4	3.31	84	1-3/4	1.64	42
1J071-24-24	1-1/2	2x12	1-1/2	4.02	102	2-1/8	1.83	46

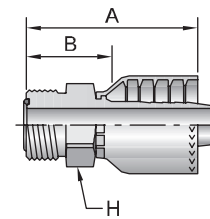

1JC71

Female Seal-Lok® - Swivel - Short

ISO 12151-1 - SWSA

# Part Number	Thread inch		Hose I.D. inch	A		C		H W		B	
	inch	inch		inch	mm	inch	mm	inch	inch	inch	mm
1JC71-8-8	1/2	13/16x16	1/2	2.22	56	0.43	11	13/16	15/16	1.01	26
1JC71-10-10	5/8	1x14	5/8	2.40	61	0.48	12	15/16	1-1/8	1.15	29
1JC71-12-12	3/4	1-3/16x12	3/4	2.68	68	0.55	14	1-1/8	1-3/8	1.30	33
1JC71-16-16	1	1-7/16x12	1	3.22	82	0.56	14	1-3/8	1-5/8	1.44	37
1JC71-20-16	1-1/4	1-11/16x12	1	3.16	80	0.59	15	1-5/8	1-7/8	1.38	35

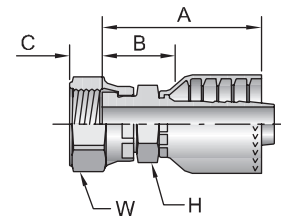

When measuring overall length to end of nut, B+C dimensions must be used to calculate cut-off allowance.

See Accessories for Flange Kits and O-Rings.

Hose
A

Fittings 71 Series
B

Equipment
C

Accessories
D

Technical
E

1JS71

Female Seal-Lok® - Swivel - Long

ISO 12151-1 - SWSB

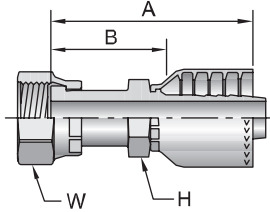

# Part Number	Thread		Hose I.D. inch	A		H inch	W inch	B	
	inch	inch		inch	mm			inch	mm
1JS71-6-6	3/8	11/16x16	3/8	2.80	58	11/16	13/16	1.38	35
1JS71-6-8	3/8	11/16x16	1/2	2.50	64	13/16	13/16	1.29	33
1JS71-8-8	1/2	13/16x16	1/2	2.64	67	13/16	15/16	1.44	37
1JS71-10-8	5/8	1x14	1/2	2.89	23	13/16	1-1/8	1.69	43
1JS71-10-10	5/8	1x14	5/8	3.00	76	15/16	1-1/8	1.75	44
1JS71-10-12	5/8	1x14	3/4	3.08	78	1-1/16	1-1/8	1.70	43
1JS71-12-10	3/4	1-3/16x12	5/8	3.10	79	1-1/8	1-3/8	1.85	47
1JS71-12-12	3/4	1-3/16x12	3/4	3.31	84	1-1/16	1-3/8	1.93	49
1JS71-16-12	1	1-7/16x12	3/4	3.37	86	1-5/16	1-5/8	1.99	51
1JS71-16-16	1	1-7/16x12	1	3.70	94	1-5/16	1-5/8	1.92	49
1JS71-20-16 [^]	1-1/4	1-11/16x12	1	3.64	92	1-3/4	1-7/8	1.94	49
1JS71-20-20	1-1/4	1-11/16x12	1-1/4	3.77	96	1-3/4	1-7/8	2.08	53
1JS71-24-24	1-1/2	2x12	1-1/2	4.51	114,6	2	2-1/4	2.32	58,9

1J771

Female Seal-Lok® - Swivel - 45° Elbow

ISO 12151-1 - SWE45

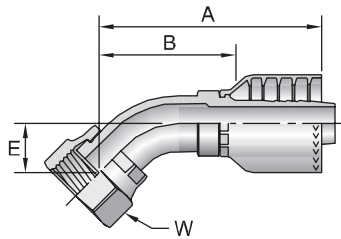

# Part Number	Thread		Hose I.D. inch	A		E		W inch	B	
	inch	inch		inch	mm	inch	mm		inch	mm
1J771-6-6	3/8	11/16x16	3/8	2.34	59	0.43	11	13/16	1.44	37
1J771-8-8	1/2	13/16x16	1/2	2.83	72	0.59	15	15/16	1.62	41
1J771-10-8	5/8	1x14	1/2	2.93	74	0.63	16	1-1/8	1.72	44
1J771-10-10	5/8	1x14	5/8	3.08	78	0.63	16	1-1/8	1.83	46
1J771-12-12	3/4	1-3/16x12	3/4	3.63	92	0.83	21	1-3/8	2.25	57
1J771-16-16	1	1-7/16x12	1	4.46	113	0.94	24	1-5/8	2.68	68
1J771-20-20	1-1/4	1-11/16x12	1-1/4	4.75	121	1.00	25	1-7/8	3.08	78
1J771-24-24	1-1/2	2x12	1-1/2	5.43	138	1.07	27	2-1/4	3.23	82

[^] Must be assembled with Die Part No. 83C-D16H in a Superkrimp or Parkrimp 2.

^{^^} Must be assembled with Die Part No. 83C-D20H in a Superkrimp or Parkrimp 2.
See Accessories for O-Rings.

1J971

Female Seal-Lok® - Swivel - 90° Elbow - Short Drop
ISO 12151-1 - SWES90

# Part Number	Thread		Hose I.D. inch	A		E		W inch	B	
	inch	inch		inch	mm	inch	mm		inch	mm
1J971-6-6	3/8	11/16x16	3/8	2.21	56	0.91	23	13/16	1.31	33
1J971-8-8	1/2	13/16x16	1/2	2.59	66	1.14	29	15/16	1.38	35
1J971-10-8	5/8	1x14	1/2	2.74	70	1.26	32	1-1/8	1.53	39
1J971-10-10	5/8	1x14	5/8	2.88	73	1.26	32	1-1/8	1.63	41
1J971-10-12	5/8	1x14	3/4	3.07	78	1.27	32	1-1/8	1.70	43
1J971-12-10	3/4	1-3/16x12	5/8	3.40	86	1.89	48	1-3/8	2.15	55
1J971-12-12	3/4	1-3/16x12	3/4	3.49	89	1.89	48	1-3/8	2.11	54
1J971-16-16	1	1-7/16x12	1	4.36	111	2.20	56	1-5/8	2.58	66
1J971-20-20	1-1/4	1-11/16x12	1-1/4	4.86	123	2.51	64	1-7/8	3.19	81
1J971-24-24	1-1/2	2x12	1-1/2	6.22	158	2.68	68	2-1/4	4.03	102

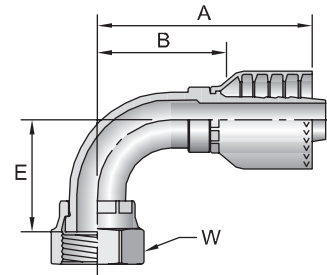

1J571

Female Seal-Lok® - Swivel - 90° Elbow - Medium Drop
ISO 12151-1 - SWSB

# Part Number	Thread		Hose I.D. inch	A		E		W inch	B	
	inch	inch		inch	mm	inch	mm		inch	mm
1J571-8-8	1/2	13/16x16	1/2	2.59	66	1.61	41	15/16	1.38	35
1J571-10-10	5/8	1x14	5/8	2.88	73	1.85	47	1-1/8	1.63	41
1J571-12-12	3/4	1-3/16x12	3/4	3.49	89	2.28	58	1-3/8	2.11	54

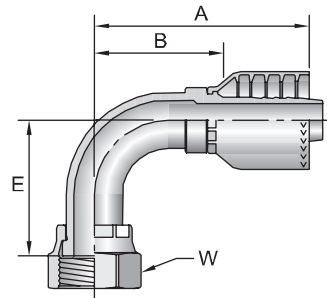

1J171

Female Seal-Lok® - Swivel - 90° Elbow - Long Drop
ISO 12151-1 - SWEL90

# Part Number	Thread		Hose I.D. inch	A		E		W inch	B	
	inch	inch		inch	mm	inch	mm		inch	mm
1J171-6-6	3/8	11/16x16	3/8	2.39	61	2.13	54	13/16	1.49	38
1J171-8-8	1/2	13/16x16	1/2	2.59	66	2.52	64	15/16	1.38	35
1J171-10-10	5/8	1x14	5/8	2.88	73	2.76	70	1-1/8	1.63	41
1J171-12-12	3/4	1-3/16x12	3/4	3.49	89	3.78	96	1-3/8	2.11	54
1J171-16-12	1	1-7/16x12	3/4	4.07	103	4.50	114	1-5/8	2.69	68
1J171-16-16	1	1-7/16x12	1	4.36	111	4.49	114	1-5/8	2.58	66
1J171-20-20 [^]	1-1/4	1-11/16x12	1-1/4	4.88	124	5.09	129	1-7/8	3.19	81
1J171-24-24	1-1/2	2x12	1-1/2	5.83	148	5.54	141	2-1/4	3.64	92

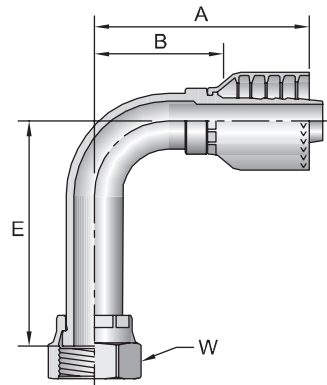

[^] Must be assembled with Die Part No. 83C-D16H in a Superkrimp or Parkrimp 2.
^{^^} Must be assembled with Die Part No. 83C-D20H in a Superkrimp or Parkrimp 2.
See Accessories for O-Rings.

Hose
A

Fittings 71 Series
B

Equipment
C

Accessories
D

Technical
E

1D271

Male Metric S - Rigid - (24° Cone)
ISO 12151-2 - S - S

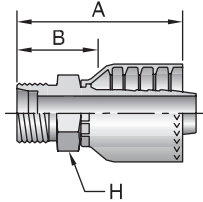

# Part Number	Thread mm	Hose I.D. inch	A		H	B	
			inch	mm	mm	inch	mm
1D271-25-12	25 M36x2	3/4	2.90	74	36	1.52	39
1D271-30-16	30 M42x2	1	3.45	88	46	1.67	42

1C971

Female Metric S - Swivel - (24° Cone with O-Ring)
ISO 12151-2 - SWS - S

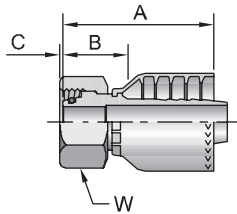

# Part Number	Thread mm	Hose I.D. inch	A		C		W	B	
			inch	mm	inch	mm	mm	inch	mm
1C971-12-6	12 M20x1,5	3/8	1.99	51	0.03	1	24	1.17	30
1C971-16-8	16 M24x1,5	1/2	2.33	59	0.09	2	30	1.18	30
1C971-20-10	20 M30x2	5/8	2.55	65	0.05	1	36	1.39	35
1C971-25-12	25 M36x2	3/4	2.68	68	0.10	3	46	1.10	28
1C971-30-16	30 M42x2	1	3.07	78	0.19	5	50	1.30	33
1C971-38-20 [^]	38 M52x2	1-1/4	3.15	80	0.23	6	60	1.30	33

When measuring overall length to end of nut, B+C dimensions must be used to calculate cut-off allowance.

1UT71

Male BSP Taper Pipe - Rigid - (60° Cone)

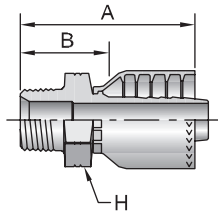

# Part Number	Hose I.D. inch	A		H	B	
		inch	mm	mm	inch	mm
1UT71-8-8	1/2	2.66	68	27	1.46	37
1UT71-12-12	3/4	2.95	75	36	1.59	40

1GU71

Female BSP Parallel Pipe - Swivel - (60° Cone)

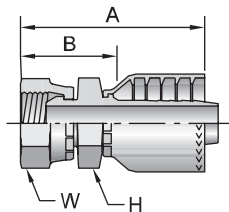

# Part Number	Thread inch		Hose I.D. inch	A		H	W	B	
	inch	mm		inch	mm	mm	mm	inch	mm
1GU71-6-6	3/8	3/8x19	3/8	2.45	62	22	22	1.55	39
1GU71-8-8	1/2	1/2x14	1/2	2.81	71	27	27	1.61	41
1GU71-12-12	3/4	3/4x14	3/4	3.24	82	36	36	1.86	47
1GU71-16-16	1	1x11	1	3.82	97	41	41	2.04	52
1GU71-20-20	1-1/4	1-1/4x11	1-1/4	4.07	103	50	50	2.38	60
1GU71-24-24	1-1/2	1-1/2x11	1-1/2	4.81	122	60	60	2.62	67
1GU71-32-32	2	2x11	2	5.17	131	70	70	2.97	75

Metric S: Mates with EO "S" Series Fittings.

[^] Must be assembled with Die Part No. 83C-D16H in a Superkrimp or Parkrimp 2.

[^] Must be assembled with Die Part No. 83C-D20H in a Superkrimp or Parkrimp 2.

See Accessories for Flange Kits and O-Rings.

1FU71

Female BSP Parallel Pipe - Swivel - (30° Flare)

# Part Number	Thread inch	Hose I.D. inch	A		H mm	W mm	B	
			inch	mm			inch	mm
1FU71-6-6	3/8x19	3/8	2.39	61	24	22	1.50	38
1FU71-8-8	1/2x14	1/2	2.71	69	27	27	1.51	38
1FU71-12-12	3/4x14	3/4	3.10	79	36	36	1.74	44
1FU71-16-16	1x11	1	3.52	89	41	41	1.93	49
1FU71-20-20	1-1/4x11	1-1/4	3.87	98	50	50	2.20	56
1FU71-24-24	1-1/2x11	1-1/2	4.66	118	60	60	2.53	64

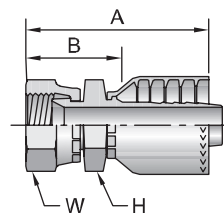

1MU71

Female Metric - Swivel - (30° Flare)

# Part Number	Thread inch	Hose I.D. inch	A		H mm	W mm	B	
			inch	mm			inch	mm
1MU71-6-6	M18x1,5	3/8	2.45	62	24	24	1.56	40
1MU71-8-8	M22x1,5	1/2	2.83	72	27	27	1.45	37

Japanese Fittings - Female Swivel 30° Flare with Metric Threads. All 30° flared fitting sizes are available by combining 1MU71 fittings in sizes up to 1/2 with 1XU71 fittings in sizes 5/8 inch and larger.

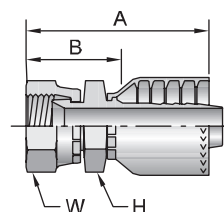

1XU71

Female Metric - Swivel - (30° Flare)

# Part Number	Thread mm	Hose I.D. inch	A		H mm	W mm	B	
			inch	mm			inch	mm
1XU71-10-10	5/8 M24x1,5	5/8	3.16	80	30	32	1.91	49
1XU71-12-12	3/4 M30x1,5	3/4	3.40	86	32	36	2.02	51
1XU71-16-16	1 M33x1,5	1	4.11	104	36	41	2.33	59
1XU71-20-20	1-1/4 M36x1,5	1-1/2	4.19	106	46	46	2.50	64
1XU71-24-24	1-1/2 M42x1,5	1-1/2	5.00	127	50	55	2.80	71

Japanese Fittings - Female Swivel 30° Flare with Metric Threads. All 30° flared fitting sizes are available by combining 1MU71 fittings in sizes up to 1/2 with 1XU71 fittings in sizes 5/8 inch and larger.

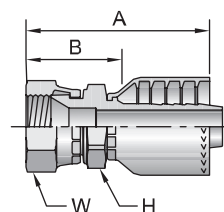

Hose
A

Fittings 71 Series
B

Equipment
C

Accessories
D

Technical
E

Hose
A











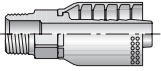

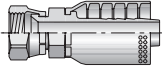
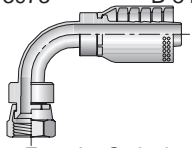

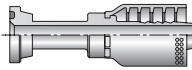
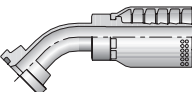
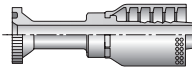
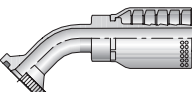
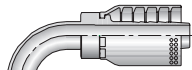
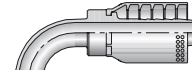

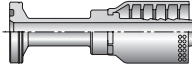
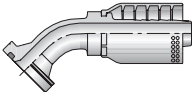
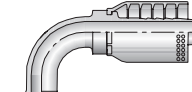
Fittings 71 Series
B

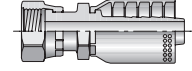
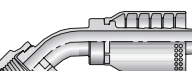
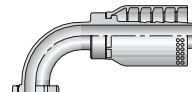
Equipment
C

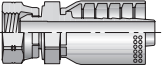
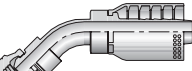
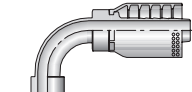
Accessories
D

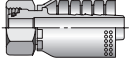
Technical
E

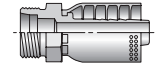
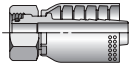
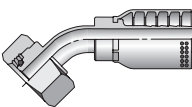
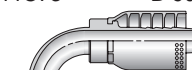

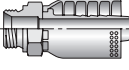
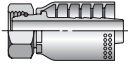
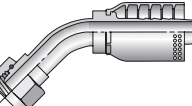
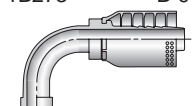
 NPTF Pipe	10173 B-84  <i>Male - Rigid</i>	 JIC 37°	10673 B-84  <i>Female - Swivel</i>	13973 B-84  <i>Female - Swivel 90° Elbow - Short</i>	 Code 61 Flange
11573 B-84  <i>Flange</i>	11773 B-85  <i>45° Elbow</i>	14A73 B-85  <i>Flange (5000 psi)</i>	14F73 B-85  <i>45° Elbow (5000 psi)</i>	11973 B-85  <i>90° Elbow</i>	14N73 B-86  <i>90° Elbow (5000 psi)</i>
 Code 62 Flange	16A73 B-86  <i>Flange</i>	16F73 B-86  <i>45° Elbow</i>	16N73 B-86  <i>90° Elbow</i>	 Seal-Lok® (O-Ring Face Seal)	1JS73 B-87  <i>Female - Swivel Long</i>
1J773 B-87  <i>Female - Swivel 45° Elbow</i>	1J973 B-87  <i>Female - Swivel 90° Elbow - Short</i>	 BSP 60° Cone	1GU73 B-88  <i>Female - Swivel</i>	1G173 B-88  <i>Female - Swivel 45° Elbow</i>	1G273 B-88  <i>Female - Swivel 90° Elbow</i>
 DIN "L" Series	1CA73 B-89  <i>Female Metric L - Swivel</i>	 DIN "S" Series	1D273 B-89  <i>Male Metric S - Rigid</i>	1C973 B-89  <i>Female Metric S - Swivel</i>	10C73 B-89  <i>Female Metric S - Swivel</i>
11C73 B-90  <i>Female Metric S - Swivel</i>	 BSP 60° Cone	1D973 B-90  <i>Male BSP - Parallel Pipe - Rigid</i>	19273 B-90  <i>Female BSP - Parallel Pipe - Swivel</i>	1B173 B-91  <i>Female BSP - Parallel Pipe - Swivel</i>	1B273 B-91  <i>Female BSP - Parallel Pipe - Swivel</i>

Hose
A

Fittings 73 Series
B

Equipment
C

Accessories
D

Technical
E

Hose
A

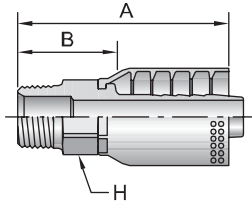

10173 Male NPTF Pipe - Rigid

# Part Number	Thread inch	Hose I.D. inch	A		H inch	B	
			inch	mm		inch	mm
10173-12-12	3/4x14	3/4	3.56	90	1-1/8	1.75	44
10173-16-16	1x11-1/2	1	3.94	100	1-3/8	2.00	51
10173-20-20	1-1/4x11-1/2	1-1/4	4.92	125	1-3/4	2.43	62
10173-24-24	1-1/2x11-1/2	1-1/2	4.88	124	2	2.57	65
10173-32-32	2x11-1/2	2	5.57	141	2-1/2	2.87	73

Fittings 73 Series
B

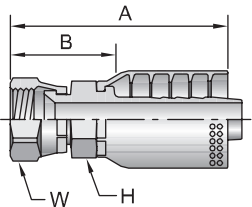

10673 Female JIC 37° - Swivel

# Part Number	Thread inch		Hose I.D. inch	A		H inch	W inch	B	
	inch	mm		inch	mm			inch	mm
10673-12-12	3/4	1-1/16x12	3/4	3.66	93	1-1/8	1-1/4	1.85	47
10673-16-12	1	1-5/16x12	3/4	3.90	99	1-3/8	1-1/2	2.09	53
10673-16-16	1	1-5/16x12	1	4.03	102	1-3/8	1-1/2	2.09	53
10673-20-20	1-1/4	1-5/8x12	1-1/4	4.93	125	1-3/4	2	2.44	62
10673-24-24	1-1/2	1-7/8x12	1-1/2	5.04	128	2	2-1/4	2.73	69
10673-32-32	2	2-1/2x12	2	5.91	150	2-1/2	2-7/8	3.21	82

Note: All sizes of 10673 fittings are rated at 5,000 psi working pressure.

Equipment
C

13973 Female JIC 37° - Swivel - 90° Elbow - Short Drop

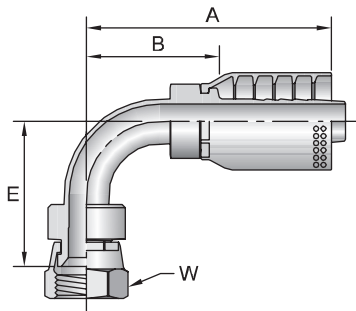

# Part Number	Thread inch		Hose I.D. inch	A		E		W inch	B	
	inch	mm		inch	mm	inch	mm		inch	mm
13973-12-12	3/4	1-1/16x12	3/4	4.12	105	2.44	62	1-1/4	2.31	59
13973-16-16	1	1-5/16x12	1	4.71	120	2.93	74	1-1/2	2.77	70

Note: All sizes of 13973 fittings are rated at 5,000 psi working pressure.

Accessories
D

11573 SAE Code 61 Flange Head ISO 12151-3 - S - L

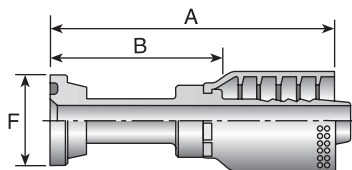

# Part Number	Flange inch	Hose I.D. inch	A		F inch	B	
			inch	mm		inch	mm
11573-12-12	3/4	3/4	4.34	110.2	1-1/2	2.53	64.3
11573-16-16	1	1	4.59	117	1-3/4	2.65	67

Technical
E

See Accessories for Flange Kits and O-Rings.

11773

SAE Code 61 Flange Head - 45° Elbow

ISO 12151-3 - E450S - L (1 Piece: ISO 12151-3 - E45M - L)

# Part Number	Flange inch	Hose I.D. inch	A		E		F inch	B	
			inch	mm	inch	mm		inch	mm
11773-12-12	3/4	3/4	4.31	109	1.02	26	1-1/2	2.50	64
11773-16-16	1	1	5.01	127	1.26	32	1-3/4	3.07	78

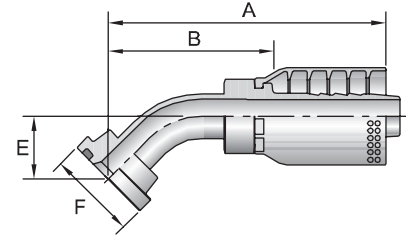

14A73

SAE Code 61 Flange Head - 5000 psi

ISO 12151-3 - S - L

# Part Number	Flange inch	Hose I.D. inch	A		F inch	B	
			inch	mm		inch	mm
14A73-20-20	1-1/4	1-1/4	5.54	141	2	3.05	77
14A73-24-24	1-1/2	1-1/2	6.53	166	2-3/8	4.22	107
14A73-32-32	2	2	6.14	156	2-13/16	3.44	87

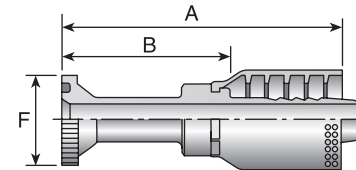

14F73

SAE Code 61 Flange Head - 45° Elbow - 5000 psi

ISO 12151-3 - E45S - L (1 Piece: ISO 12151-3 - E45M - L)

# Part Number	Flange inch	Hose I.D. inch	A		E		F inch	B	
			inch	mm	inch	mm		inch	mm
14F73-20-20	1-1/4	1-1/4	6.39	162	150	38	2	3.90	99
14F73-24-24	1-1/2	1-1/2	6.99	178	1.73	44	2-3/8	4.68	119
14F73-32-32	2	2	8.40	214	2.21	56	2-13/16	5.71	145

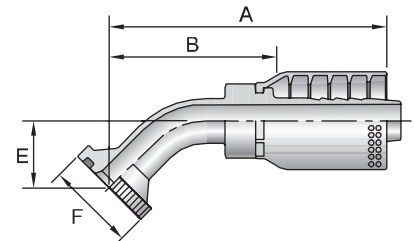

11973

SAE Code 61 Flange Head - 90° Elbow

ISO 12151-3 - E90S - L (1 Piece: ISO 12151-3 - E90M - L)

# Part Number	Flange inch	Hose I.D. inch	A		E		F inch	B	
			inch	mm	inch	mm		inch	mm
11973-12-12	3/4	3/4	3.97	101	2.28	58	1-1/2	2.16	55
11973-16-12	1	3/4	4.00	102	2.28	58	1-3/4	2.19	56
11973-16-16	1	1	4.63	118	2.76	70	1-3/4	2.69	68

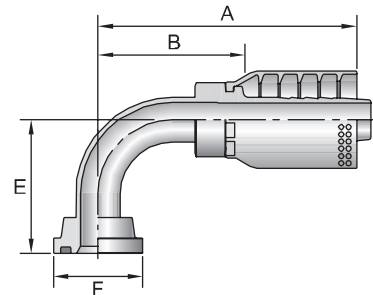

Hose
A

Fittings 73 Series
B

Equipment
C

Accessories
D

Technical
E

Hose
A

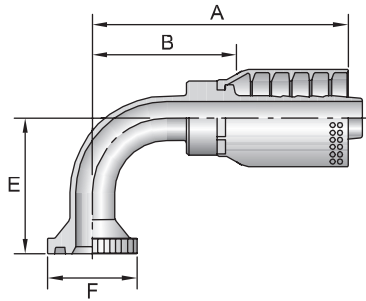

14N73

SAE Code 61 Flange Head - 90° Elbow - 5000 psi

ISO 12151-3 - E90S - L (1 Piece: ISO 12151-3 - E90M - L)

# Part Number	Flange inch	Hose I.D. inch	A		E		F inch	B	
			inch	mm	inch	mm		inch	mm
14N73-20-20	1-1/4	1-1/4	6.09	155	3.54	90	2	3.60	91
14N73-24-24	1-1/2	1-1/2	6.52	166	4.09	104	2-3/8	4.21	107
14N73-32-32	2	2	7.82	199	5.43	138	2-13/16	5.12	130

Fittings 73 Series
B

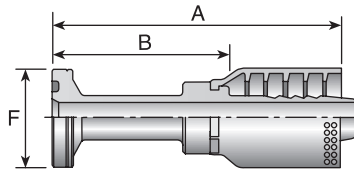

16A73

SAE Code 62 Flange Head

ISO 12151-3 - S - S

# Part Number	Flange inch	Hose I.D. inch	A		F inch	B	
			inch	mm		inch	mm
16A73-12-12	3/4	3/4	4.60	117	1-5/8	2.79	71
16A73-16-16	1	1	5.16	131	1-7/8	3.22	82
16A73-20-16	1-1/4	1	3.95	100	2-1/8	2.01	51
16A73-20-20	1-1/4	1-1/4	5.85	149	2-1/8	3.36	85
16A73-24-24	1-1/2	1-1/2	6.54	166	2-1/2	4.23	107
16A73-32-32	2	2	7.63	194	3-1/8	4.93	125

Equipment
C

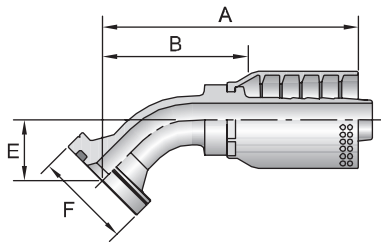

16F73

SAE Code 62 Flange Head - 45° Elbow

ISO 12151-3 - E45S - S (1 Piece: ISO 12151-3 - E45M - S)

# Part Number	Flange inch	Hose I.D. inch	A		E		F inch	B	
			inch	mm	inch	mm		inch	mm
16F73-12-12	3/4	3/4	4.31	109	1.02	26	1-5/8	2.50	64
16F73-16-16	1	1	5.01	127	1.26	32	1-7/8	3.07	78
16F73-20-20	1-1/4	1-1/4	6.39	162	1.50	38	2-1/8	3.90	99

Accessories
D

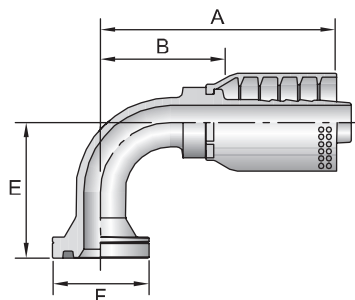

16N73

SAE Code 62 Flange Head - 90° Elbow

ISO 12151-3 - E90S - S (1 Piece: ISO 12151-3 - E90M - S)

# Part Number	Flange inch	Hose I.D. inch	A		E		F inch	B	
			inch	mm	inch	mm		inch	mm
16N73-12-12	3/4	3/4	3.97	101	2.28	58	1-5/8	2.16	55
16N73-16-16	1	1	4.63	118	2.76	70	1-7/8	2.69	68
16N73-20-20	1-1/4	1-1/4	6.09	151	3.54	90	2-1/8	3.60	91
16N73-24-24	1-1/2	1-1/2	6.52	166	4.09	104	2-1/2	4.21	107
16N73-32-32	2	2	7.82	199	5.43	138	3-1/8	5.12	130

Technical
E

1JS73

Female Seal-Lok® - Swivel - Long

ISO 12151-1 - SWSB

# Part Number	Thread		Hose I.D. inch	A		H inch	W inch	B	
	inch	1-3/16x12		inch	mm			inch	mm
1JS73-12-12	3/4	1-3/16x12	3/4	3.70	94	1-1/8	1-3/8	1.89	48
1JS73-16-12	1	1-7/16x12	3/4	3.78	96	1-3/8	1-5/8	1.97	50
1JS73-16-16	1	1-7/16x12	1	4.03	102	1-3/8	1-5/8	2.09	53
1JS73-20-20	1-1/4	1-11/16x12	1-1/4	4.62	132	1-3/4	1-7/8	2.13	69

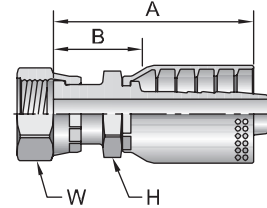

1J773

Female Seal-Lok® - Swivel - 45° Elbow

ISO 12151-1 - SWE45

# Part Number	Thread		Hose I.D. inch	A		E		W inch	B	
	inch	1-3/16x12		inch	mm	inch	mm		inch	mm
1J773-12-12	3/4	1-3/16x12	3/4	4.11	104	0.81	21	1-3/8	2.30	58
1J773-16-16	1	1-7/16x12	1	4.69	119	0.94	24	1-5/8	2.75	70
1J773-20-20	1-1/4	1-11/16x12	1-1/4	5.78	147	0.98	25	1-7/8	3.29	84

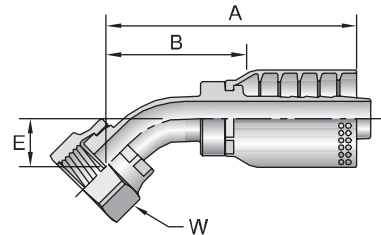

1J973

Female Seal-Lok® - Swivel - 90° Elbow - Short Drop

ISO 12151-1 - SWES90

# Part Number	Thread		Hose I.D. inch	A		E		W inch	B	
	inch	1-3/16x12		inch	mm	inch	mm		inch	mm
1J973-12-12	3/4	1-3/16x12	3/4	3.97	100	1.89	48	1-3/8	2.16	55
1J973-16-16	1	1-7/16x12	1	4.62	117	2.20	56	1-5/8	2.68	68
1J973-20-20	1-1/4	1-11/16x12	1-1/4	5.82	148	2.52	64	1-7/8	3.33	85

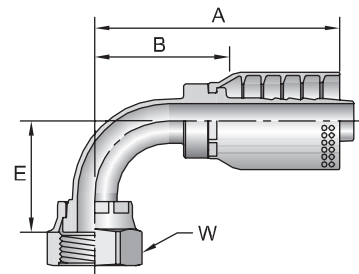

Metric S: Mates with EO "S" Series Fittings.

Hose
A

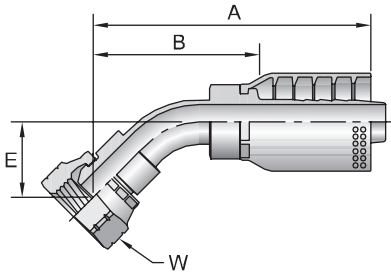

1G173

Female BSP Parallel Pipe - Swivel - 45° Elbow - (60° Cone)

# Part Number	Thread inch	Hose I.D. inch	A		E		W mm	B	
			inch	mm	inch	mm		inch	mm
1G173-12-12	3/4x14	3/4	4.77	121,2	1.35	34,4	36	2.96	75,2
1G173-16-16	1x11	1	5.36	136,1	1.52	38,7	41	3.42	86,9

Fittings 73 Series
B

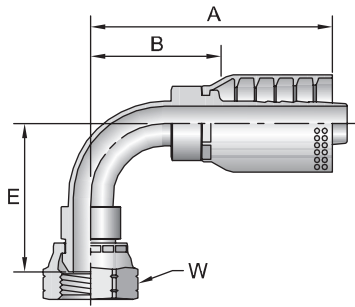

1G273

Female BSP Parallel Pipe - Swivel - 90° Elbow - (60° Cone)

# Part Number	Thread inch	Hose I.D. inch	A		E		W mm	B	
			inch	mm	inch	mm		inch	mm
1G273-12-12	3/4x14	3/4	4.12	104,6	2.62	66,6	36	2.31	58,7
1G273-16-16	1x11	1	4.71	119,6	3.04	77,2	41	2.77	70,4

Equipment
C

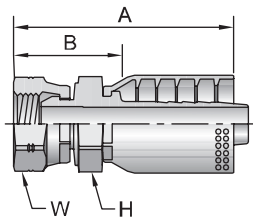

1GU73

Female BSP Parallel Pipe - Swivel - (60° Cone)

# Part Number	Thread inch	Hose I.D. inch	A		H mm	W mm	B	
			inch	mm			inch	mm
1GU73-12-12	3/4x14	3/4	3.76	95,5	36	36	1.95	49,5
1GU73-16-16	1x11	1	4.14	105	41	41	2.20	56

Accessories
D

Technical
E

Metric S: Mates with EO "S" Series Fittings
^ Must use Parkrimp 2 with Die Part No. 83C-L20.

1CA73

Female Metric L - Swivel - (24° Cone with O-Ring)

ISO 12151-2 - SWS

# Part Number	Thread mm	Hose I.D. inch	A		C		W mm	B	
			inch	mm	inch	mm		inch	mm
1CA73-28-16	25 M36x2	1	3.43	87	0.14	3.56	41	1.42	36

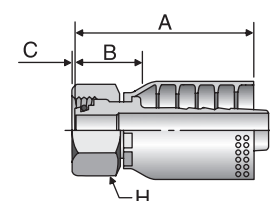

1D273

Male Metric S - Rigid - (24° Cone)

ISO 8434-1

# Part Number	Thread mm	Hose I.D. inch	A		H mm	B	
			inch	mm		inch	mm
1D273-20-12	20 M30x2	3/4	3.31	84	30	1.42	36
1D273-25-12	25 M36x2	3/4	3.39	86	36	1.50	38
1D273-30-16	30 M42x2	1	3.70	94	46	1.73	44
1D273-38-20	38 M52x2	1-1/4	4.41	112	55	1.89	48

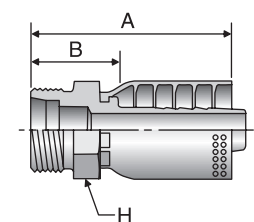

1C973

Female Metric S - Swivel - (24° Cone with O-Ring)

ISO 12151-2 - SWS

# Part Number	Thread mm	Hose I.D. inch	A		C		W mm	B	
			inch	mm	inch	mm		inch	mm
1C973-20-12	20 M30x2	3/4	3.19	81	0.05	1.3	36	1.30	33
1C973-25-12	25 M36x2	3/4	3.15	80	0.09	2.3	46	1.26	32
1C973-25-16	25 M36x2	1	3.43	87	0.09	2.3	46	1.42	36
1C973-30-16	30 M42x2	1	3.43	87	0.19	4.8	50	1.42	36
1C973-30-20	30 M42x2	1-1/4	4.17	106	0.19	4.8	50	1.65	42
1C973-38-20	38 M52x2	1-1/4	4.02	102	0.23	5.8	60	1.38	35

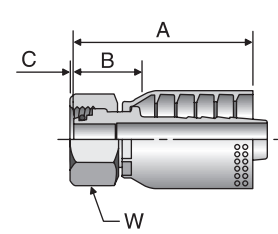

10C73

Female Metric S - Swivel - 45° Elbow - (24° Cone with O-Ring)

ISO 12151-2 - SWE45 - S

# Part Number	Thread mm	Hose I.D. inch	A		E		W mm	B	
			inch	mm	inch	mm		inch	mm
10C73-20-12	20 M30x2	3/4	4.41	112	1.10	28	36	2.52	64
10C73-25-12	25 M36x2	3/4	4.45	113	1.14	29	46	2.56	65
10C73-30-16	30 M42x2	1	5.16	131	1.34	34	50	3.19	81

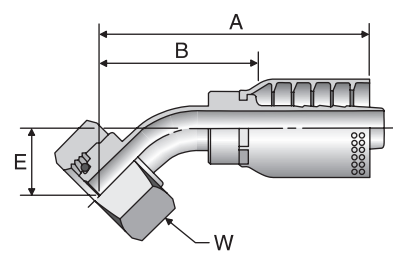

Hose
A

Fittings 73 Series
B

Equipment
C

Accessories
D

Technical
E

Hose
A

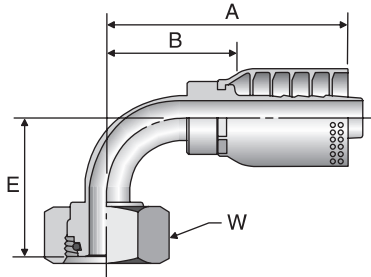

11C73

Female Metric S - Swivel - 90° Elbow - (24° Cone with O-Ring)
ISO 12151-2 - SWE - S

# Part Number	Thread		Hose I.D.		A		E		W		B	
	mm		inch	mm	inch	mm	inch	mm	mm	inch	mm	
11C73-20-12	20	M30X2	3/4	3.98	101	2.24	57	36	2.09	53		
11C73-25-12	25	M36X2	3/4	3.98	101	2.32	59	46	2.05	52		
11C73-25-16	25	M36X2	1	4.80	122	2.76	70	46	2.80	71		
11C73-30-16	30	M42X2	1	4.80	122	2.87	73	50	2.83	72		
11C73-38-20	38	M52X2	1-1/4	5.94	151	3.07	78	60	3.43	87		

Fittings 73 Series
B

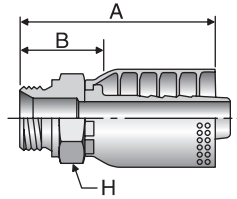

1D973

Male BSP Parallel Pipe - Rigid - (60° Cone)
ISO 228-1

# Part Number	Thread		Hose I.D.		A		H		B	
	BSP		inch	mm	inch	mm	mm	inch	mm	
1D973-12-12	19,1	3/4x14	3/4	3.43	87	32	1.50	38		
1D973-16-16	25,4	1x11	1	3.74	95	41	1.69	43		

Equipment
C

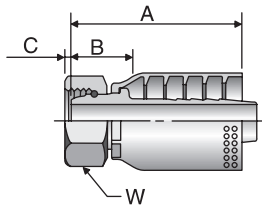

19273

Female BSP Parallel Pipe - Swivel - (60° Cone)
ISO 228-1

# Part Number	Thread		Hose I.D.		A		C		W		B	
	inch		inch	mm	inch	mm	inch	mm	mm	inch	mm	
19273-12-12	3/4x14		3/4	3.03	77	0.46	11.7	32	1.14	29		
19273-16-16	1x11		1	3.50	89	0.44	11.2	41	1.50	38		
19273-20-20	1-1/4x11		1-1/4	3.98	101	0.52	13.2	50	1.46	37		

Accessories
D

Technical
E

1B173

Female BSP Parallel Pipe - Swivel- 45° Elbow - (60° Cone)

ISO 228-1

# Part Number	Thread inch	Hose I.D. inch	A		E		W mm	B	
			inch	mm	inch	mm		inch	mm
1B173-12-12	3/4x14	3/4	4.33	110	1.02	26	32	2.44	62
1B173-16-16	1x11	1	5.35	136	1.54	39	41	3.31	84

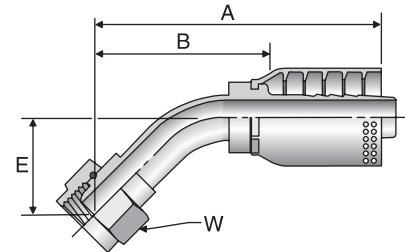

1B273

Female BSP Parallel Pipe - Swivel - 90° Elbow - (60° Cone)

ISO 228-1

# Part Number	Thread inch	Hose I.D. inch	A		E		W mm	B	
			inch	mm	inch	mm		inch	mm
1B273-12-12	3/4x14	3/4	4.17	106	2.17	55	32	2.28	58
1B273-16-16	1x11	1	4.76	121	2.99	76	41	2.76	70
1B273-20-20	1-1/4x11	1-1/4	5.94	151	3.15	80	50	3.43	87

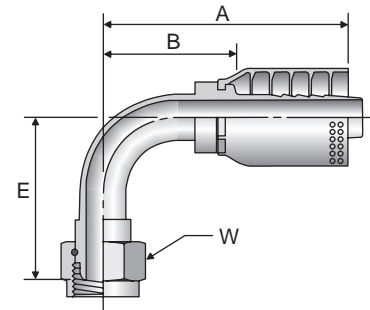

Hose
A

Fittings 73 Series
B

Equipment
C

Accessories
D

Technical
E

Hose
A

Fittings 76 Series
B

Equipment
C

Accessories
D

Technical
E

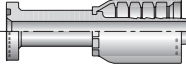
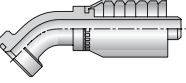
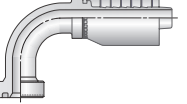
	<p>18A76 B-91</p>  <p><i>Flange</i></p>	<p>18F76 B-91</p>  <p><i>45° Elbow</i></p>	<p>18N76 B-91</p>  <p><i>90° Elbow</i></p>
---	---	--	---

18A76

Flange Head - 8,000 psi

# Part Number	Flange inch	Hose I.D. inch	A		F inch	B	
			inch	mm		inch	mm
18A76-12-12	3/4	3/4	5.29	134	1-5/8	2.96	75
18A76-16-16	1	1	5.72	145	1-7/8	3.17	81

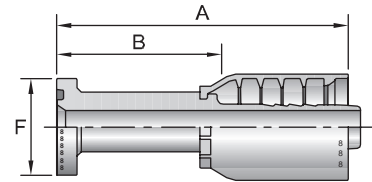

18F76

Flange Head - 45° Elbow - 8,000 psi

# Part Number	Flange inch	Hose I.D. inch	A		E		F inch	B	
			inch	mm	inch	mm		inch	mm
18F76-12-12	3/4	3/4	4.95	125,7	1.024	26	1-5/8	2.62	66,5
18F76-16-16	1	1	6.10	155,0	1.260	32	1-7/8	3.55	90,1

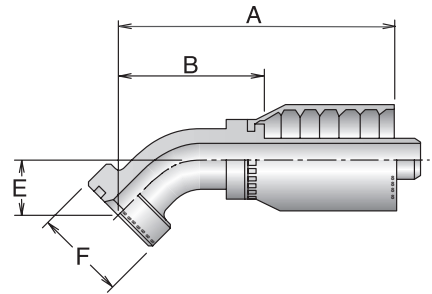

18N76

Flange Head - 90° Elbow - 8,000 psi

# Part Number	Flange inch	Hose I.D. inch	A		E		F inch	B	
			inch	mm	inch	mm		inch	mm
18N76-12-12	3/4	3/4	4.81	122,1	2.76	70	1-5/8	2.48	63
18N76-16-16	1	1	5.88	149,5	2.76	70	1-7/8	3.33	84,6

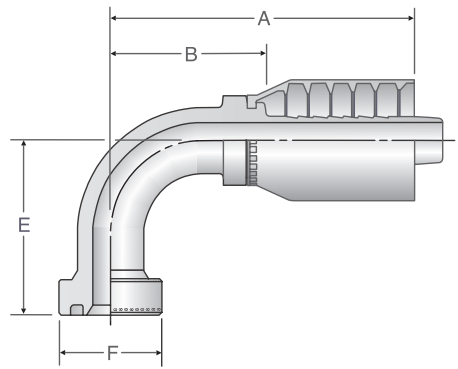

See Accessories for O-Rings and Flange Kits.











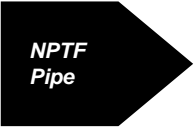
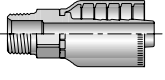

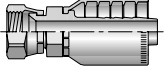
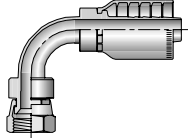

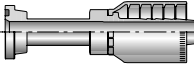
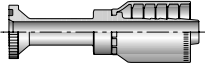
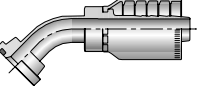
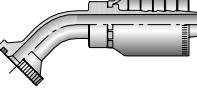
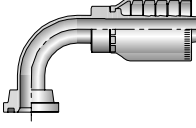
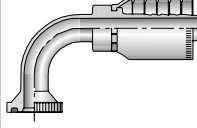

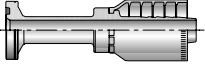
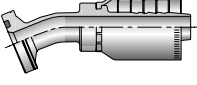
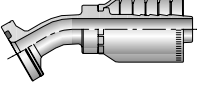
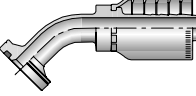
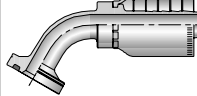
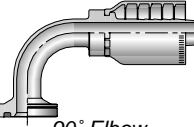
Hose
A

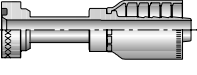
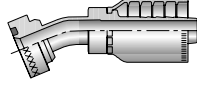
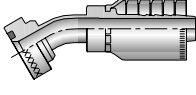
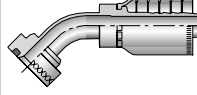
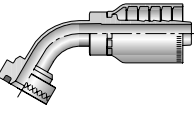
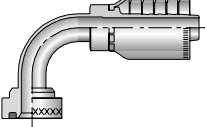

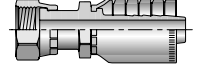
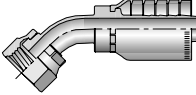
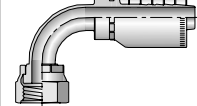

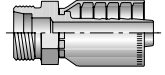

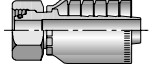
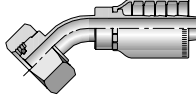
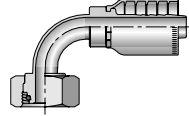

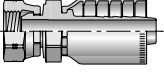

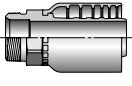
Fittings 78 Series
B

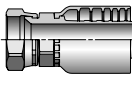
Equipment
C

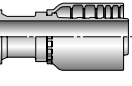
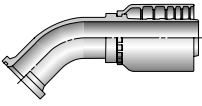
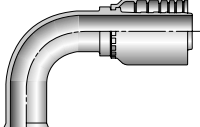
Accessories
D

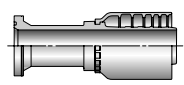
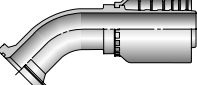
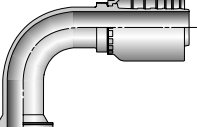
Technical
E

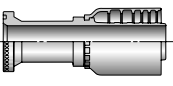
 NPTF Pipe	10178 B-96  Male - Rigid	 JIC 37°	10678 B-96  Female - Swivel	13978 B-96  Female - Swivel	 Code 61 Flange
11578 B-96  Flange	14A78 B-97  Flange (5000 psi)	11778 B-97  45° Elbow	14F78 B-97  45° Elbow (5000 psi)	11978 B-97  90° Elbow	14N78 B-98  90° Elbow (5000 psi)
 Code 62 Flange	16A78 B-98  Flange	16B78 B-98  22-1/2° Elbow	16E78 B-98  30° Elbow	16F78 B-99  45° Elbow	16G78 B-99  60° Elbow
16N78 B-99  90° Elbow	 Caterpillar® Flange	1XA78 B-100  Flange	1XB78 B-100  22-1/2° Elbow	1XE78 B-100  30° Elbow	1XF78 B-101  45° Elbow
1XG78 B-101  60° Elbow	1XN78 B-101  90° Elbow	 Seal-Lok® (O-Ring Face Seal)	1JS78 B-102  Female - Swivel Long	1J778 B-102  Female - Swivel 45° Elbow	1J978 B-102  Female - Swivel 90° Elbow - Short
 DIN "S" Series	1D278 B-103  Male - Rigid	 DIN "S" Series w/O-Ring	1C978 B-103  Female - Rigid	10C78 B-103  Female - Swivel 45° Elbow	11C78 B-103  Female - Swivel 90° Elbow
 BSP 60° Cone	1GU78 B-103  Female - Swivel				

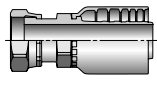
 <p>NPTF Pipe</p>	<p>101S6 B-104</p>  <p>Male - Rigid</p>	 <p>JIC 37°</p>	<p>106S6 B-104</p>  <p>Female - Swivel</p>	 <p>Code 61 Flange</p>	<p>14AS6 B-104</p>  <p>Flange (5000 psi)</p>
<p>14FS6 B-104</p>  <p>45° Elbow (5000 psi)</p>	<p>14NS6 B-104</p>  <p>90° Elbow (5000 psi)</p>	 <p>Code 62 Flange</p>	<p>16AS6 B-105</p>  <p>Flange Head - Straight</p>	<p>16FS6 B-105</p>  <p>45° Elbow</p>	<p>16NS6 B-105</p>  <p>90° Elbow</p>
 <p>Caterpillar® Flange</p>	<p>1XAS6 B-105</p>  <p>Flange</p>	 <p>Seal-Lok® (O-Ring Face Seal)</p>	<p>1JSS6 B-105</p>  <p>Female - Swivel</p>		

Hose
A

Fittings 78 Series
B

Equipment
C

Accessories
D

Technical
E

Hose
A

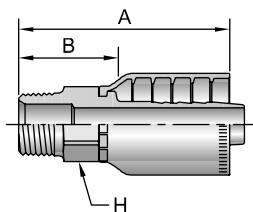

10178 Male NPTF Pipe - Rigid

# Part Number	Thread inch	Hose I.D. inch	A		H		B	
			inch	mm	inch	inch	inch	mm
10178-12-12	3/4x14	3/4	3.56	90	1-1/8	1.80	46	
10178-16-16	1x11-1/2	1	3.94	100	1-3/8	2.09	53	
10178-20-20	1-1/4x11-1/2	1-1/4	4.92	125	1-3/4	2.53	64	
10178-24-24	1-1/2x11-1/2	1-1/2	4.88	124	2	2.67	68	

Fittings 78 Series
B

10678 Female JIC 37° - Swivel

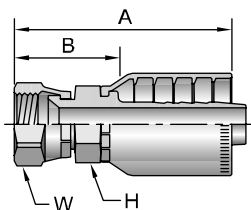

# Part Number	Thread inch	Hose I.D. inch	A		H		W		B		Additional Material Stainless Steel (C)
			inch	mm	inch	inch	inch	mm	inch	mm	
10678-12-12	3/4 1-1/16x12	3/4	3.66	93	1-1/8	1-1/4	1.90	48		•	
10678-16-12	1 1-5/16x12	3/4	3.90	99	1-3/8	1-1/2	2.14	54		•	
10678-16-16	1 1-5/16x12	1	4.03	102	1-3/8	1-1/2	2.18	55		•	
10678-20-20	1-1/4 1-5/8x12	1-1/4	4.93	125	1-3/4	2	2.54	65		•	
10678-24-24	1-1/2 1-7/8x12	1-1/2	5.04	128	2	2-1/4	2.83	72		•	

All sizes of 10678 fittings are rated at 5,000 psi working pressure.

Equipment
C

13978 Female JIC 37° - Swivel - 90° Elbow - Short Drop

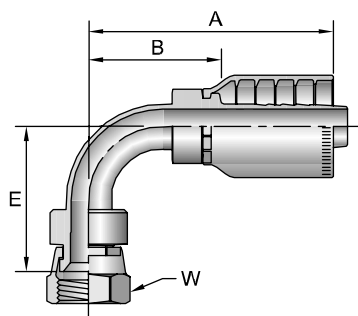

# Part Number	Thread inch	Hose I.D. inch	A		E		W		B	
			inch	mm	inch	mm	inch	inch	inch	mm
13978-12-12	3/4 1-1/16x12	3/4	4.12	105	2.44	62	1-1/2	2.36	60	
13978-16-16	1 1-5/16x12	1	4.71	120	2.93	74	1-1/2	2.86	73	
13978-20-20	1-1/4 1-5/8x12	1-1/4	5.67	144	3.35	85	2	3.28	83	

All sizes of 13978 fittings are rated at 5,000 psi working pressure.

Accessories
D

11578 SAE Code 61 Flange Head ISO 12151-3 - S - L

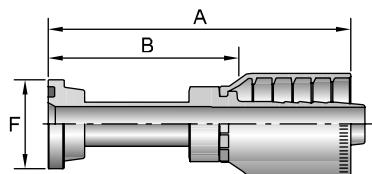

# Part Number	Flange inch	Hose I.D. inch	A		F		B	
			inch	mm	inch	inch	inch	mm
11578-12-12	3/4	3/4	4.34	110	1-1/2	2.58	66	
11578-16-16	1	1	4.59	117	1-3/4	2.74	70	

See Accessories for O-Rings and Flange Kits.

Technical
E

14A78

SAE Code 61 Flange Head - 5,000 psi

ISO 12151-3 - S - L (5000 psi)

# Part Number	Flange inch	Hose I.D. inch	A		F inch	B	
			inch	mm		inch	mm
14A78-20-20	1-1/4	1-1/4	5.54	141	2	3.15	80
14A78-24-24	1-1/2	1-1/2	6.53	166	2-3/8	4.32	110
14A78-32-24	2	1-1/2	4.68	119	2-13/16	2.47	63

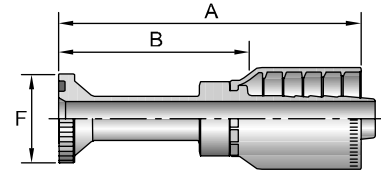

11778

SAE Code 61 Flange Head - 45° Elbow

ISO 12151-3 - E45S - L (1 Piece: ISO 12151-3 - E45M - L)

# Part Number	Flange inch	Hose I.D. inch	A		E		F inch	B	
			inch	mm	inch	mm		inch	mm
11778-12-12	3/4	3/4	4.67	119	1.06	27	1-1/2	2.91	74
11778-16-16	1	1	5.01	127	1.26	32	1-3/4	3.16	80

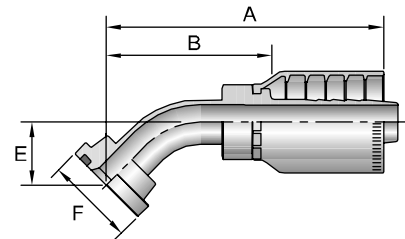

14F78

SAE Code 61 Flange Head - 45° Elbow - 5,000 psi

ISO 12151-3 - E45S - L (1 Piece: ISO 12151-3 - E45M - L) (5000 psi)

# Part Number	Flange inch	Hose I.D. inch	A		E		F inch	B	
			inch	mm	inch	mm		inch	mm
14F78-20-20	1-1/4	1-1/4	6.39	162	1.50	38	2	4.00	102
14F78-24-24	1-1/2	1-1/2	6.99	178	1.73	44	2-3/8	4.78	121

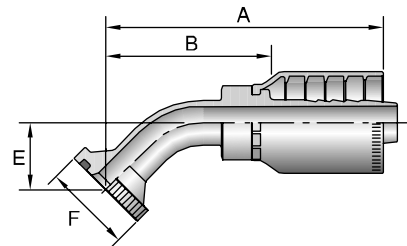

11978

SAE Code 61 Flange Head - 90° Elbow

ISO 12151-3 - E90S - L (1 Piece: ISO 12151-3 - E90M - L)

# Part Number	Flange inch	Hose I.D. inch	A		E		F inch	B	
			inch	mm	inch	mm		inch	mm
11978-12-12	3/4	3/4	4.35	110	2.25	57	1-1/2	2.59	66
11978-16-16	1	1	4.67	119	2.76	70	1-3/4	2.82	72

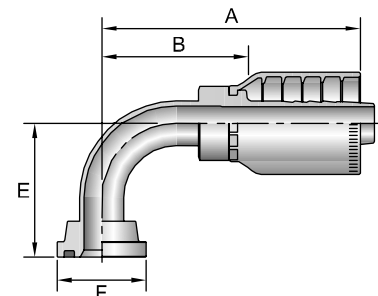

See Accessories for O-Rings and Flange Kits.

Hose
A

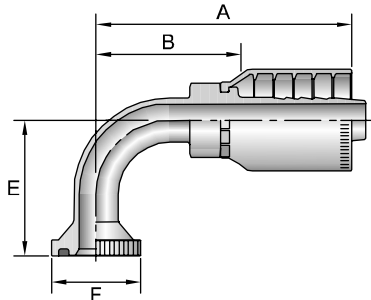

14N78

SAE Code 61 Flange Head - 90° Elbow - 5,000 psi

ISO 12151-3 - E90S - L (1 Piece: ISO 12151-3 - E90M - L) (5000 psi)

#	Flange	Hose I.D.	A		E		F	B	
Part Number	inch	inch	inch	mm	inch	mm	inch	inch	mm
14N78-20-16	1-1/4	1	4.63	118	2.76	70	2	2.78	71
14N78-20-20	1-1/4	1-1/4	6.09	155	3.54	90	2	3.70	94
14N78-24-24	1-1/2	1-1/2	6.52	166	4.09	104	2-3/8	4.31	109

Fittings 78 Series
B

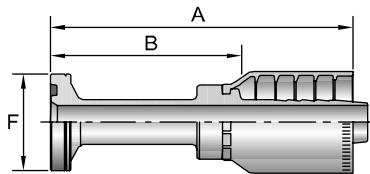

16A78

SAE Code 62 Flange Head

ISO 12151-3 - S - S

#	Flange	Hose I.D.	A		F	B	
Part Number	inch	inch	inch	mm	inch	inch	mm
16A78-12-12	3/4	3/4	4.60	117	1-5/8	2.84	72
16A78-16-12	1	3/4	3.57	91	1-7/8	1.81	46
16A78-16-16	1	1	5.16	131	1-7/8	3.31	84
16A78-20-16	1-1/4	1	3.95	100	2-1/8	2.10	53
16A78-20-20	1-1/4	1-1/4	5.85	149	2-1/8	3.46	88
16A78-24-20	1-1/2	1-1/4	4.77	121	2-1/2	2.38	60
16A78-24-24	1-1/2	1-1/2	6.54	166	2-1/2	4.33	110
16A78-32-24	2	1-1/2	5.07	129	3-1/8	2.86	73

Equipment
C

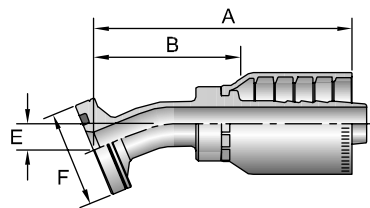

16B78

SAE Code 62 Flange Head - 22-1/2° Elbow

ISO 12151-3 - E22M - S

#	Flange	Hose I.D.	A		E	F	B		
Part Number	inch	inch	inch	mm	inch	mm	inch	mm	
16B78-16-16	1	1	4.57	116	0.46	12	1-7/8	2.72	60

Accessories
D

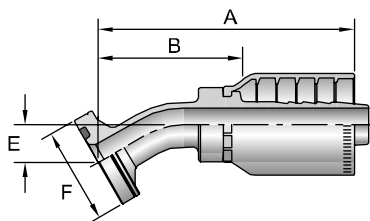

16E78

SAE Code 62 Flange Head - 30° Elbow

ISO 12151-3 - E30S - S (1 Piece: ISO 12151-3 - E30M - S)

#	Flange	Hose I.D.	A		E		F	B	
Part Number	inch	inch	inch	mm	inch	mm	inch	inch	mm
16E78-20-20	1-1/4	1-1/4	6.71	170	0.87	22	2-1/8	4.32	110
16E78-24-24	1-1/2	1-1/2	7.10	180	1.12	28	2-1/2	4.89	124



Technical
E

See Accessories for O-Rings and Flange Kits.

16F78

SAE Code 62 Flange Head - 45° Elbow

ISO 12151-3 - E45S - S (1 Piece: ISO 12151-3 - E45M - S)

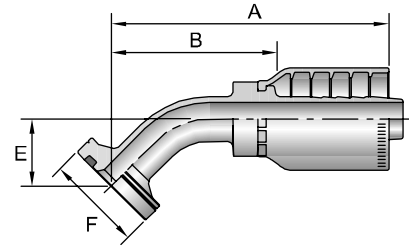

#			A		E			B	
			inch	mm	inch	mm		inch	mm
16F78-12-12	3/4	3/4	4.31	109	1.02	26	1-5/8	2.55	65
16F78-16-12	1	3/4	4.83	123	1.22	31	1-7/8	3.07	78
16F78-16-16	1	1	5.04	128	1.26	32	1-7/8	3.19	81
16F78-20-16	1-1/4	1	5.01	127	1.26	32	2-1/8	3.16	80
16F78-20-20	1-1/4	1-1/4	6.39	162	1.50	38	2-1/8	4.00	102
16F78-24-20	1-1/2	1-1/4	6.39	162	1.50	38	2-1/2	4.00	102
16F78-24-24	1-1/2	1-1/2	6.99	178	1.73	44	2-1/2	4.78	121



16G78

SAE Code 62 Flange Head - 60° Elbow

ISO 12151-3 - E60S - S (1 Piece: ISO 12151-3 - E60M - S)

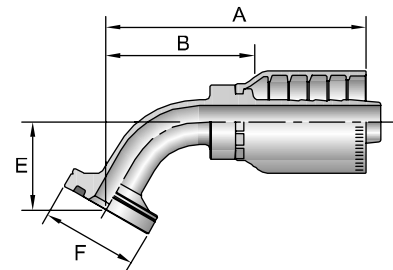

#			A		E			B	
			inch	mm	inch	mm		inch	mm
16G78-16-16	1	1	5.85	149	1.73	44	1-7/8	4.00	102
16G78-20-20	1-1/4	1-1/4	7.72	196	2.17	55	2-1/8	5.33	135
16G78-24-24	1-1/2	1-1/2	8.41	214	2.52	64	2-1/2	6.20	157



16N78

SAE Code 62 Flange Head - 90° Elbow

ISO 12151-3 - E90S - S (1 Piece: ISO 12151-3 - E90M - S)

#			A		E			B	
			inch	mm	inch	mm		inch	mm
16N78-12-12	3/4	3/4	4.00	102	2.28	58	1-5/8	2.24	57
16N78-16-12	1	3/4	3.97	101	2.28	58	1-7/8	2.21	56
16N78-16-16	1	1	4.63	118	2.76	70	1-7/8	2.78	71
16N78-20-16	1-1/4	1	4.63	118	2.76	70	2-1/8	2.78	71
16N78-20-20	1-1/4	1-1/4	6.09	155	3.54	90	2-1/8	3.70	94
16N78-24-16	1-1/2	1	5.04	126	2.70	69	2-1/2	3.19	81
16N78-24-20	1-1/2	1-1/4	6.09	155	3.54	90	2-1/2	3.70	94
16N78-24-24	1-1/2	1-1/2	6.52	166	4.09	104	2-1/2	4.31	109
16N78-32-24	2	1-1/2	6.52	166	4.09	104	3-1/8	4.31	109

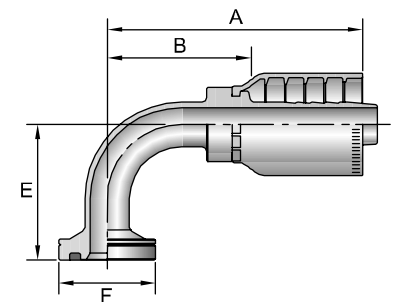

See Accessories for O-Rings and Flange Kits.

Hose
A

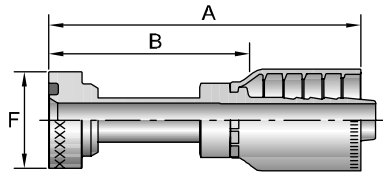

1XA78 Caterpillar® Flange Head

# Part Number	Flange inch	Hose I.D. inch	A		F inch	B	
			inch	mm		inch	mm
1XA78-12-12	3/4	3/4	4.85	123,2	1-5/8	3.09	78,5
1XA78-16-12	1	3/4	5.29	134,4	1-7/8	3.53	89,7
1XA78-16-16	1	1	5.44	138,2	1-7/8	3.59	91,2
1XA78-20-16	1-1/4	1	5.65	143,5	2-1/8	3.80	96,5
1XA78-20-20	1-1/4	1-1/4	6.10	154,9	2-1/8	3.71	94,2
1XA78-24-20	1-1/2	1-1/4	6.35	161,3	2-1/2	3.96	100,6
1XA78-24-24	1-1/2	1-1/2	6.78	172,2	2-1/2	4.57	116,1

Fittings 78 Series
B

1XB78 Caterpillar® Flange Head - 22-1/2° Elbow

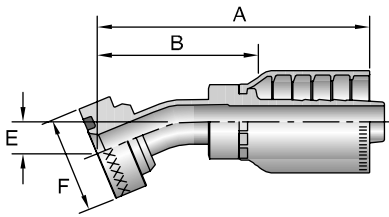

# Part Number	Flange inch	Hose I.D. inch	A		E		F inch	B	
			inch	mm	inch	mm		inch	mm
1XB78-12-12	3/4	3/4	4.59	117	0.54	14	1-5/8	2.83	72
1XB78-16-16	1	1	4.66	118	0.50	13	1-7/8	2.81	71
1XB78-20-16	1-1/4	1	4.66	118	0.50	13	2-1/8	2.81	71
1XB78-20-20	1-1/4	1-1/4	7.21	183	0.80	20	2-1/8	4.82	122
1XB78-24-20	1-1/2	1-1/4	7.21	183	0.80	20	2-1/2	4.82	122
1XB78-24-24	1-1/2	1-1/2	7.08	180	0.73	19	2-1/2	4.87	124

Equipment
C

1XE78 Caterpillar® Flange Head - 30° Elbow

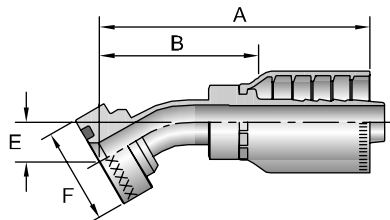

# Part Number	Flange inch	Hose I.D. inch	A		E		F inch	B	
			inch	mm	inch	mm		inch	mm
1XE78-16-16	1	1	5.08	129	0.79	20	1-7/8	3.23	82
1XE78-20-16	1-1/4	1	5.10	128	0.80	20	2-1/8	3.25	83
1XE78-20-20	1-1/4	1-1/4	6.38	162	0.93	24	2-1/8	3.99	101
1XE78-24-20	1-1/2	1-1/4	6.38	162	0.93	24	2-1/2	3.99	101
1XE78-24-24	1-1/2	1-1/2	7.10	180	1.14	29	2-1/2	4.89	124

Accessories
D

Technical
E

Caterpillar® style fittings conform to the bolt hole patterns of SAE Code 62 and require special flange halves and seals. The Caterpillar® style flange heads are thicker than SAE Code 62 and measure to a .560" thickness in all sizes.

See Accessories for O-Rings and Flange Kits.

1XF78

Caterpillar® Flange Head - 45° Elbow

# Part Number	Flange inch	Hose I.D. inch	A		E		F inch	B	
			inch	mm	inch	mm		inch	mm
1XF78-12-12	3/4	3/4	4.82	122	1.21	31	1-5/8	3.06	78
1XF78-16-12	1	3/4	4.81	120	1.20	30	1-7/8	3.05	77
1XF78-16-16	1	1	5.46	139	1.43	36	1-7/8	3.61	92
1XF78-20-16	1-1/4	1	5.46	139	1.43	36	2-1/8	3.61	92
1XF78-20-20	1-1/4	1-1/4	6.38	162	1.44	37	2-1/8	3.99	101
1XF78-24-20	1-1/2	1-1/4	6.38	162	1.44	37	2-1/2	3.99	101
1XF78-24-24	1-1/2	1-1/2	6.89	175	1.54	39	2-1/2	4.68	119

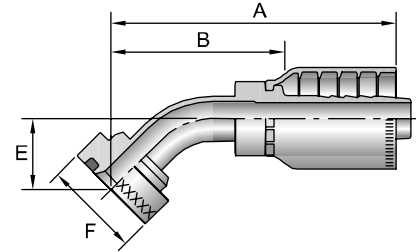

1XG78

Caterpillar® Flange Head - 60° Elbow

# Part Number	Flange inch	Hose I.D. inch	A		E		F inch	B	
			inch	mm	inch	mm		inch	mm
1XG78-16-16	1	1	5.13	130	1.96	50	1-7/8	3.28	83
1XG78-20-20	1-1/4	1-1/4	6.72	171	2.02	51	2-1/8	4.33	110
1XG78-24-24	1-1/2	1-1/2	6.87	174	2.04	52	2-1/2	4.67	119

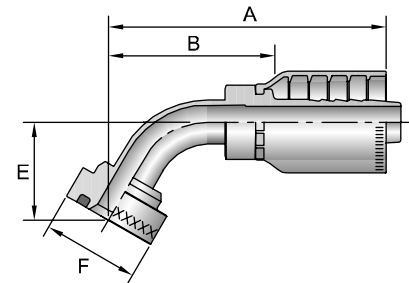

1XN78

Caterpillar® Flange Head - 90° Elbow

# Part Number	Flange inch	Hose I.D. inch	A		E		F inch	B	
			inch	mm	inch	mm		inch	mm
1XN78-12-12	3/4	3/4	4.35	110	2.46	62	1-5/8	2.59	66
1XN78-12-16	3/4	1	4.58	116	2.46	62	1-5/8	2.73	69
1XN78-16-12	1	3/4	4.35	110	2.44	62	1-7/8	2.59	66
1XN78-16-16	1	1	5.04	128	2.90	74	1-7/8	3.19	81
1XN78-20-16	1-1/4	1	5.04	128	2.90	74	2-1/8	3.19	81
1XN78-20-20	1-1/4	1-1/4	6.75	171	3.02	77	2-1/8	4.36	111
1XN78-24-20	1-1/2	1-1/4	6.75	171	3.02	77	2-1/2	4.36	111
1XN78-24-24	1-1/2	1-1/2	5.85	149	3.41	87	2-1/2	3.64	92

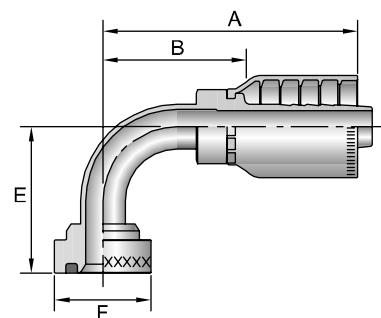

Caterpillar® style fittings conform to the bolt hole patterns of SAE Code 62 and require special flange halves and seals. The Caterpillar® style flange heads are thicker than SAE Code 62 and measure to a .560" thickness in all sizes.

See Accessories for O-Rings and Flange Kits.

Hose
A

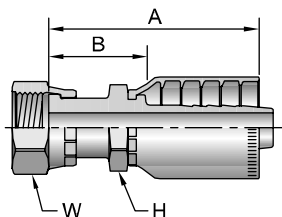

1JS78

Female Seal-Lok® - Swivel - Long
ISO 12151-1 - SWSB

# Part Number	Thread		Hose I.D. inch	A		H inch	W inch	B	
	inch	inch		inch	mm			inch	mm
1JS78-12-12	3/4	1-3/16x12	3/4	3.70	94	1-1/8	1-3/8	1.94	49
1JS78-16-16	1	1-7/16x12	1	4.03	102	1-3/8	1-5/8	2.18	55
1JS78-20-16	1-1/4	1-11/16x12	1	3.99	101	1-3/4	1-7/8	2.14	54
1JS78-20-20	1-1/4	1-11/16x12	1-1/4	4.62	117	1-3/4	1-7/8	2.23	57
1JS78-24-24	1-1/2	2-12	1-1/2	4.70	119,4	2	2-1/4	2.49	63,2

Fittings 78 Series
B

1J778

Female Seal-Lok® - Swivel - 45° Elbow
ISO 12151-1 - SWE45

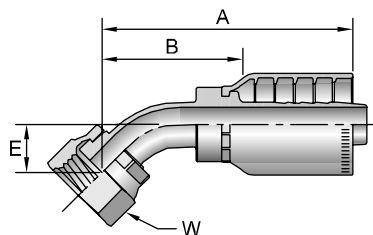

# Part Number	Thread		Hose I.D. inch	A		E		W inch	B	
	inch	inch		inch	mm	inch	mm		inch	mm
1J778-12-12	3/4	1-3/16x12	3/4	4.11	104	0.81	21	1-3/8	2.35	60
1J778-16-16	1	1-7/16x12	1	4.69	119	0.94	24	1-5/8	2.84	72
1J778-20-20	1-1/4	1-11/16x12	1-1/4	5.78	147	0.98	25	1-7/8	3.29	84
1J778-24-24	1-1/2	2x12	1-1/2	6.91	176	1.56	40	2-1/4	4.70	119

Equipment
C

1J978

Female Seal-Lok® - Swivel - 90° Elbow - Short Drop
ISO 12151-1 - SWES90

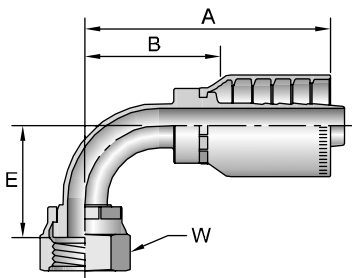

# Part Number	Thread		Hose I.D. inch	A		E		W inch	B	
	inch	inch		inch	mm	inch	mm		inch	mm
1J978-12-12	3/4	1-3/16x12	3/4	3.97	100	1.89	48	1-3/8	2.21	56
1J978-16-16	1	1-7/16x12	1	4.62	117	2.21	56	1-5/8	2.77	70
1J978-20-20	1-1/4	1-11/16x12	1-1/4	5.82	148	2.52	64	1-7/8	3.43	87
1J978-24-24	1-1/2	2x12	1-1/2	6.58	167	2.70	69	2-1/4	4.37	111

Accessories
D

Technical
E

See Accessories for O-Rings and Flange Kits.

1D278

Male Metric S - Rigid - (24° Cone)

# Part Number	Thread		Hose I.D. inch	A		H mm	B	
	mm	M		inch	mm		inch	mm
1D278-25-12	25	M36x2	3/4	3.38	86	36	1.62	41
1D278-30-16	30	M42x2	1	3.72	94	46	1.87	47
1D278-38-20	38	M52x2	1-1/4	4.42	112	55	2.03	52

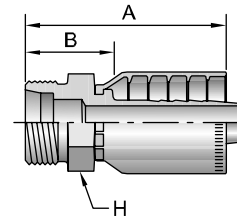

1C978

Female Metric S - Swivel - (24° Cone with O-Ring)

# Part Number	Thread		Hose I.D. inch	A		C		W mm	B	
	mm	M		inch	mm	inch	mm		inch	mm
1C978-25-12	25	M36x2	3/4	3.12	79	0.10	3	46	1.36	35
1C978-30-16	30	M42x2	1	3.40	86	0.19	5	50	1.55	39
1C978-38-20	38	M52x2	1-1/4	3.98	101	0.23	6	60	1.59	40

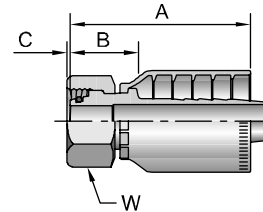

When measuring overall length to the end of the nut, B+C dimensions must be used to calculate cut-off allowance.

10C78

Female Metric S - Swivel - 45° Elbow - (24° Cone with O-Ring)
ISO 12151-2 - SWE45 - S

# Part Number	Thread		Hose I.D. inch	A		E		W mm	B	
	mm	M		inch	mm	inch	mm		inch	mm
10C78-25-12	25	M36x2	3/4	4.45	113	1.14	29	46	2.56	65
10C78-30-16	30	M42x2	1	5.16	131	1.34	34	50	3.19	81
10C78-38-20	38	M52x2	1-1/4	6.44	164	1.50	38	60	4.05	103

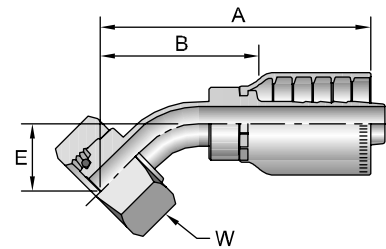

11C78

Female Metric S - Swivel - 90° Elbow - (24° Cone with O-Ring)
ISO 12151-2 - SWE - S

# Part Number	Thread		Hose I.D. inch	A		E		W mm	B	
	mm	M		inch	mm	inch	mm		inch	mm
11C78-25-12	25	M36x2	3/4	4.12	105	2.32	59	46	2.36	60
11C78-30-16	30	M42x2	1	4.71	120	2.68	68	50	2.86	73
11C78-38-20	38	M52x2	1-1/4	5.67	144	2.86	73	60	3.28	83

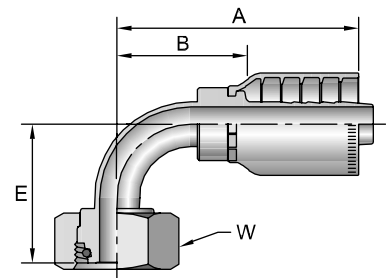

1GU78

Female BSP Parallel Pipe - Swivel - (60° Cone)

# Part Number	Thread		Hose I.D. inch	A		H mm	W mm	B	
	inch	BSP		inch	mm			inch	mm
1GU78-12-12	3/4x14		3/4	3.76	96	36	36	2.00	51
1GU78-16-16	1x11		1	4.14	105	41	41	2.29	58

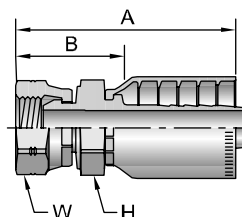

Metric S: Mates with EO "S" Series Fittings. See Accessories for O-Rings and Flange Kits.

Hose
A

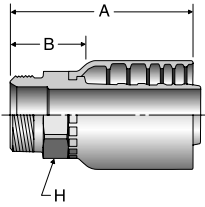

101S6

Male NPTF Pipe - Rigid

# Part Number	Thread inch	Hose I.D. inch	A		H	B	
			inch	mm	inch	mm	
101S6-32-32	2 x 11 1/2	2	5.88	149,5	2-1/2	2.44	61,9

Fittings 78 Series
B

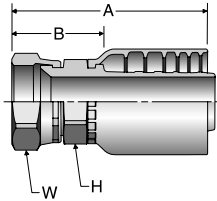

106S6

Female JIC 37° - Swivel

# Part Number	Thread inch	Hose I.D. inch	A		H	B	
			inch	mm	inch	mm	
106S6-32-32	2 1/2 x 12	2	6.52	165,7	2.5	3.08	78,2

106S6 is rated at 5,000 psi working pressure.

Equipment
C

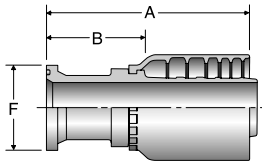

14AS6

SAE Code 61 Flange Head - 5,000 psi
ISO 12151-3-S-L (5,000 psi)

# Part Number	Flange inch	Hose I.D. inch	A		F	B		E	
			inch	mm	inch	inch	mm	inch	mm
14AS6-32-32	2	2	6.72	170,8	2-13/16	3.28	83,3	-	-

Accessories
D

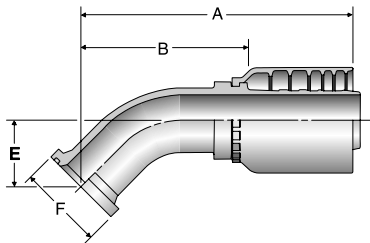

14FS6

SAE Code 61 Flange Head - 45° Elbow - 5,000 psi
ISO 12151-3-E-45S-L (1 Piece: ISO 12151-3-E45M-L) (5,000 psi)

# Part Number	Flange inch	Hose I.D. inch	A		F	B		E	
			inch	mm	inch	inch	mm	inch	mm
14FS6-32-32	2	2	9.00	228,7	2-13/16	5.56	141,2	2.205	56,0

Technical
E

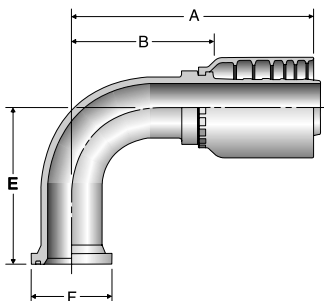

14NS6

SAE Code 61 Flange Head - 90° Elbow - 5,000 psi
ISO 12151-3-E-90S-L (1 Piece: ISO 12151-3-E90M-L) (5,000 psi)

# Part Number	Flange inch	Hose I.D. inch	A		F	B		E	
			inch	mm	inch	inch	mm	inch	mm
14NS6-32-32	2	2	8.41	213,7	2-13/16	4.97	126,2	5.433	138,0

16AS6

SAE Code 62 Flange Head

ISO 12151-3-S-S

# Part Number	Flange inch	Hose I.D. inch	A		F	B		E	
			inch	mm	inch	inch	mm	inch	mm
16AS6-32-32	2	2	8.21	208,6	3-1/8	4.77	121,1	-	-

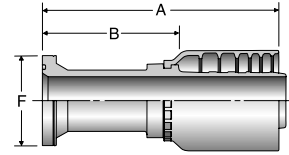

16FS6

SAE Code 62 Flange Head - 45° Elbow

ISO 12151-3-E45S-S (1 Piece: ISO 1251-3-E45-M-S)

# Part Number	Flange inch	Hose I.D. inch	A		F	B		E	
			inch	mm	inch	inch	mm	inch	mm
16FS6-32-32	2	2	9.00	208,6	3-1/8	5.56	141,2	2.205	56,0

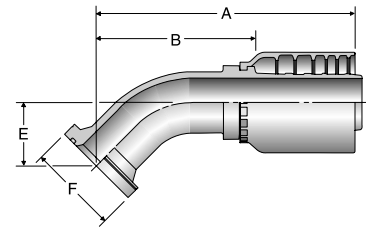

16NS6

SAE Code 62 Flange Head - 90° Elbow

ISO 12151-3-E90S-S (1 Piece: ISO 1251-3-E90M-S)

# Part Number	Flange inch	Hose I.D. inch	A		F	B		E	
			inch	mm	inch	inch	mm	inch	mm
16NS6-32-32	2	2	8.41	213,7	3-1/8	4.97	126,2	5.43	138,0

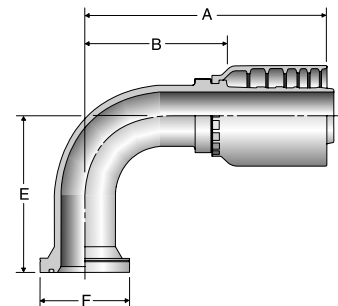

1XAS6

Caterpillar® Flange Head

# Part Number	Flange inch	Hose I.D. inch	A		F	B	
			inch	mm	inch	inch	mm
1XAS6-32-32	2	2	8.21	208,6	3-1/8	4.77	121

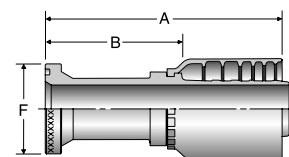

1JSS6

Female Seal-Lok - Swivel - Long

ISO 12151-1-SWSB

# Part Number	Thread inch	Hose I.D. inch	A		H	W	B	
			inch	mm	inch	inch	inch	mm
1JSS6-32-32	2-1/2X12	2	6.46	164,2	2.5	2-7/8	3.02	76,7

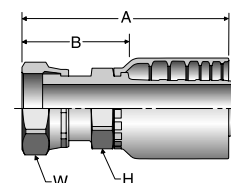

Hose
A

Fittings 78 Series
B

Equipment
C

Accessories
D

Technical
E

A Hose





B Fittings 78 Series

C Equipment

D Accessories

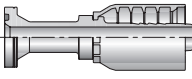
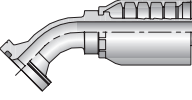
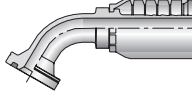
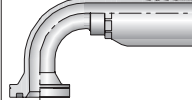
E Technical

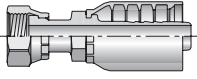
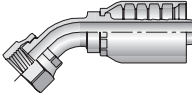
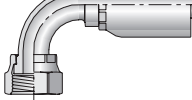

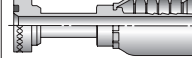
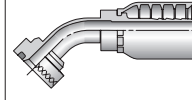
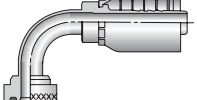
 <p>Code 62 Flange</p>	<p>16A79 B-108</p>  <p><i>Flange</i></p>	<p>16F79 B-108</p>  <p><i>45° Elbow</i></p>	<p>16G79 B-108</p>  <p><i>60° Elbow</i></p>	<p>16N79 B-109</p>  <p><i>90° Elbow</i></p>	 <p>Seal-Lok® (O-Ring Face Seal)</p>
<p>1JS79 B-109</p>  <p><i>Female - Swivel Long</i></p>	<p>1J779 B-109</p>  <p><i>Female - Swivel 45° Elbow</i></p>	<p>1J979 B-109</p>  <p><i>Female - Swivel 90° Elbow - Short</i></p>	 <p>Flange Head</p>	<p>1XA79 B-110</p>  <p><i>Flange Head</i></p>	<p>1XF79 B-110</p>  <p><i>45° Elbow</i></p>
<p>1XN79 B-110</p>  <p><i>90° Elbow</i></p>					

A	Hose
B	Fittings 79 Series
C	Equipment
D	Accessories
E	Technical

Hose
A

Fittings 79 Series
B

Equipment
C

Accessories
D

Technical
E

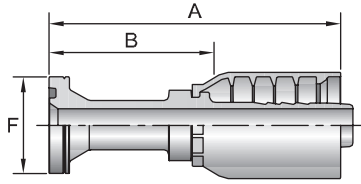

16A79
SAE Code 62 Flange Head
ISO 12151-3 - S - S

# Part Number	Flange inch	Hose I.D. inch	A		F		B	
			inch	mm	inch	mm	inch	mm
16A79-12-12	3/4	3/4	4.90	124	1-5/8	2.84	72	
16A79-16-12	1	3/4	3.88	99	1-7/8	1.82	46	
16A79-16-16	1	1	5.48	139	1-7/8	3.31	84	
16A79-20-16	1-1/4	1	4.28	109	2-1/8	2.11	54	
16A79-20-20	1-1/4	1-1/4	6.09	155	2-1/8	3.41	87	
16A79-24-24	1-1/2	1-1/2	7.11	181	1-1/2	4.07	103	

16F79
SAE Code 62 Flange Head - 45° Elbow
ISO 12151-3 - E45S - S (1 Piece: ISO 12151-3 - E45M - S)

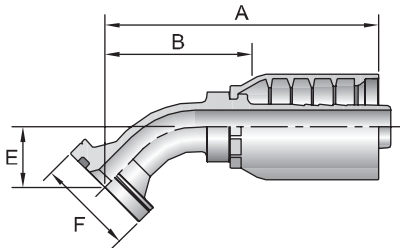

# Part Number	Flange inch	Hose I.D. inch	A		E		F		B	
			inch	mm	inch	mm	inch	mm	inch	mm
16F79-12-12	3/4	3/4	4.61	117	1.02	26	1-5/8	2.55	65	
16F79-16-16	1	1	5.33	135	1.26	32	1-7/8	3.16	80	
16F79-16-20	1	1-1/4	6.25	159	1.50	38	1-7/8	3.57	91	
16F79-20-16	1-1/4	1	5.33	135	1.26	32	2-1/8	3.16	80	
16F79-20-20	1-1/4	1-1/4	6.77	172	1.50	38	2-1/8	4.09	104	
16F79-24-24	1-1/2	1-1/2	7.96	202	1.73	44	2-1/2	4.07	103	

16G79
SAE Code 62 Flange Head - 60° Elbow
ISO 12151-3 - E60S - S (1 Piece: ISO 12151-3 - E60M - S)

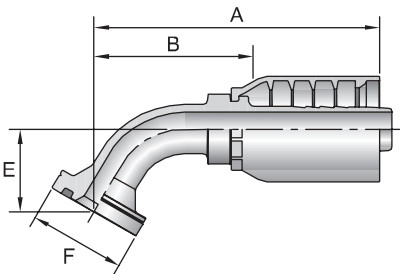

# Part Number	Flange inch	Hose I.D. inch	A		E		F		B	
			inch	mm	inch	mm	inch	mm	inch	mm
16G79-16-16	1	1	6.18	157	1.73	44	1-7/8	4.01	102	

See Accessories for O-Rings and Flange Kits.

16N79

SAE Code 62 Flange Head - 90° Elbow

ISO 12151-3 - E90S - S (1 Piece: ISO 12151-3 - E90M - S)

# Part Number	Flange inch	Hose I.D. inch	A		E		F		B	
			inch	mm	inch	mm	inch	mm	inch	mm
16N79-12-12	3/4	3/4	4.27	108	2.28	58	1-5/8	2.21	56	
16N79-16-12	1	3/4	4.27	108	2.28	58	1-7/8	2.21	56	
16N79-16-16	1	1	4.95	126	2.76	70	1-7/8	2.78	71	
16N79-20-16	1-1/4	1	4.95	126	2.76	70	2-1/8	2.78	71	
16N79-20-20	1-1/4	1-1/4	6.31	160	3.54	90	2-1/8	3.63	92	
16N79-24-24	1-1/2	1-1/2	7.50	190	4.09	104	2-1/2	4.46	113	

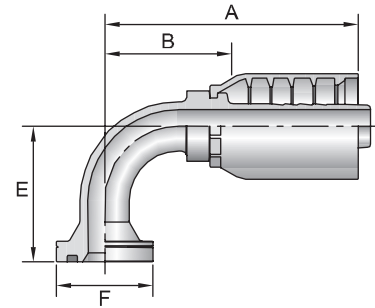

1JS79

Female Seal-Lok® - Swivel - Long

ISO 12151-1 - SWSB

# Part Number	Thread inch		Hose I.D. inch	A		H	W	B	
	inch	mm		inch	mm	inch	mm	inch	mm
1JS79-12-12	3/4	1-3/16x12	3/4	3.99	101	1-1/8	1-3/8	1.93	49
1JS79-16-12	1	1-7/16x12	3/4	4.26	108	1-3/8	1-5/8	2.20	56
1JS79-16-16	1	1-7/16x12	1	4.45	113	1-3/8	1-5/8	2.28	58
1JS79-20-16	1-1/4	1-11/16x12	1	4.32	110	1-3/4	1-7/8	2.15	55
1JS79-20-20	1-1/4	1-11/16x12	1-1/4	5.00	127	1-3/4	1-7/8	2.32	59
1JS79-24-24	1-1/2	2x12	1-1/2	5.28	134	2	2-1/4	2.24	57

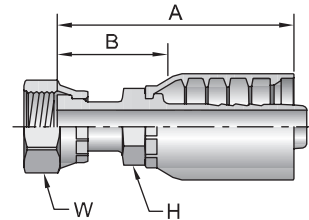

1J779

Female Seal-Lok® - Swivel - 45° Elbow

ISO 12151-1 - SWE45

# Part Number	Thread inch		Hose I.D. inch	A		E		W	B	
	inch	mm		inch	mm	inch	mm	inch	mm	
1J779-12-12	3/4	1-3/16x12	3/4	4.40	112	0.83	21	1-3/8	2.34	59
1J779-16-16	1	1-7/16x12	1	5.01	127	0.94	24	1-5/8	2.84	72
1J779-20-20	1-1/4	1-11/16x12	1-1/4	6.15	156	1.00	25	1-7/8	3.49	89

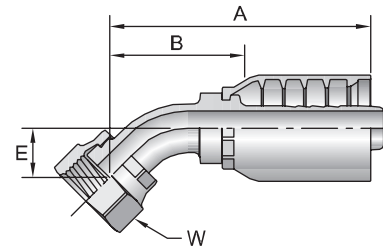

1J979

Female Seal-Lok® - Swivel - 90° Elbow - Short Drop

ISO - 12151-1 - SWES90

# Part Number	Thread inch		Hose I.D. inch	A		E		W	B	
	inch	mm		inch	mm	inch	mm	inch	mm	
1J979-12-12	3/4	1-3/16x12	3/4	4.27	108	1.88	48	1-3/8	2.21	56
1J979-16-16	1	1-7/16x12	1	4.95	126	2.21	56	1-5/8	2.78	71
1J979-20-20	1-1/4	1-11/16x12	1-1/4	6.20	157	2.52	64	1-7/8	3.52	89

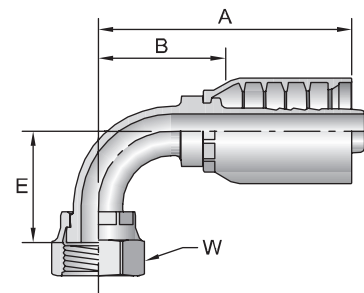

See Accessories for O-Rings and Flange kits.

Hose
A

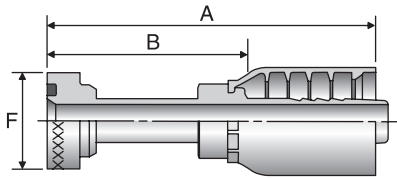

1XA79 Caterpillar® Flange Head

# Part Number	Flange inch	Hose I.D. inch	A		F		B	
			inch	mm	inch	inch	inch	mm
1XA79-12-12	3/4	3/4	4.89	124	1-5/8	2.83	72	
1XA79-16-16	1	1	5.75	146	1-7/8	3.59	91	
1XA79-20-16	1-1/4	1	4.32	110	2-1/8	2.15	55	
1XA79-20-20	1-1/4	1-1/4	6.25	159	2-1/8	3.57	91	
1XA79-24-24	1-1/2	1-1/2	7.17	182	2-1/2	4.13	105	

Fittings 79 Series
B

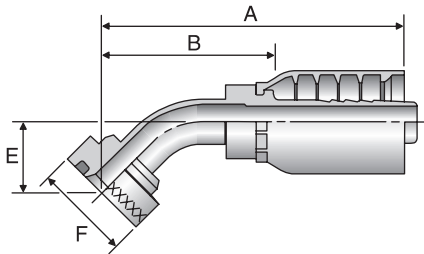

1XF79 Caterpillar® Flange Head - 45° Elbow

# Part Number	Flange inch	Hose I.D. inch	A		E		F		B	
			inch	mm	inch	mm	inch	inch	inch	mm
1XF79-12-12	3/4	3/4	4.80	122	1.22	31	1-5/8	2.74	70	
1XF79-16-16	1	1	5.49	139	1.42	36	1-7/8	3.32	84	
1XF79-20-16	1-1/4	1	5.49	139	1.42	36	2-1/8	3.32	84	
1XF79-20-20	1-1/4	1-1/4	6.72	171	1.44	37	2-1/8	4.04	103	

Equipment
C

1XN79 Caterpillar® Flange Head - 90° Elbow

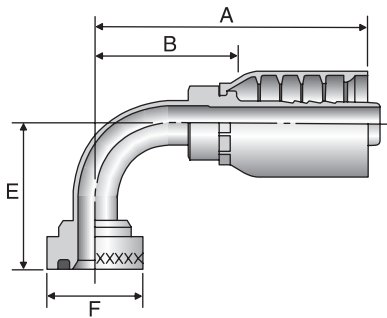

# Part Number	Flange inch	Hose I.D. inch	A		E		F		B	
			inch	mm	inch	mm	inch	inch	inch	mm
1XN79-12-12	3/4	3/4	4.27	108	2.48	63	1-5/8	2.21	56	
1XN79-16-16	1	1	4.94	125	2.91	74	1-7/8	2.78	71	
1XN79-20-16	1-1/4	1	4.94	125	2.91	74	2-1/8	2.78	71	
1XN79-20-20	1-1/4	1-1/4	6.31	160	3.70	94	2-1/8	3.63	92	
1XN79-24-24	1-1/2	1-1/2	7.50	191	4.16	106	2-1/2	4.46	113	

Accessories
D

Technical
E

Hose
A

Fittings 79 Series
B

Equipment
C

Accessories
D

Technical
E











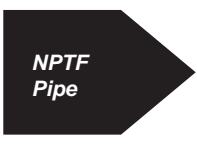
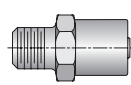

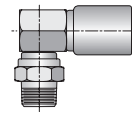
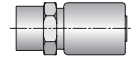

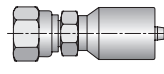

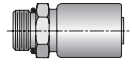

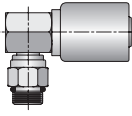

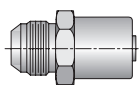
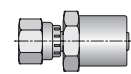
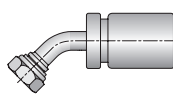
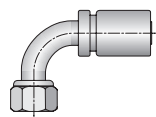
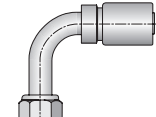
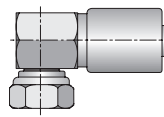

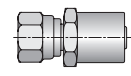
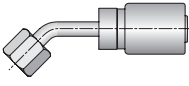
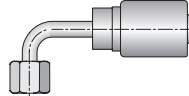

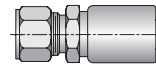

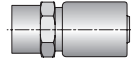

Hose
A

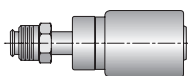
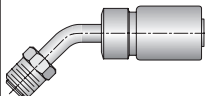
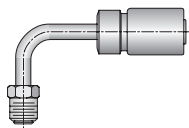
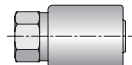
Fittings HY Series
B

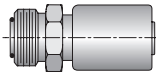
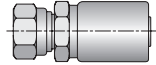
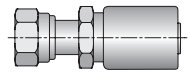
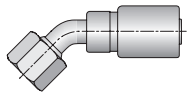
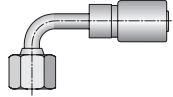
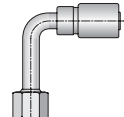
Equipment
C

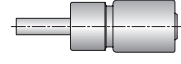
Accessories
D

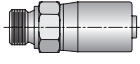
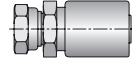
Technical
E

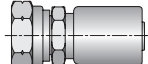
 NPTF Pipe	101HY B-113  Male - Rigid	113HY B-113  Male - Swivel	11LHY B-114  Male - Swivel 90° Elbow	102HY B-114  Female - Rigid	 NPSM Pipe
107HY B-114  Female - Swivel (60° Cone)	 Straight Thread	105HY B-115  Male - Rigid	10GHY B-115  Male - Swivel	10LHY B-116  Swivel - Swivel 90° Elbow	 JIC 37°
103HY B-116  Male - Rigid	106HY B-117  Female - Swivel	137HY B-118  Female - Swivel 45° Elbow - Short	139HY B-118  Female - Swivel 90° Elbow - Short	141HY B-119  Female - Swivel 90° Elbow - Long	193HY B-119  Female - Swivel 90° Elbow - Block
 SAE 45°	108HY B-119  Female - Swivel	177HY B-120  Female - Swivel 45° Elbow	179HY B-120  Female - Swivel 90° Elbow	 Flareless	111HY B-120  Male - Rigid
 Grease Connection	1GJHY B-120  Female - Rigid	 Standpipe	134HY B-121  Male Standpipe Rigid	 Inverted Flare	128HY B-121  Male - Swivel
167HY B-121  Male - Swivel 45° Elbow	169HY B-122  Male - Swivel 90° Elbow	129HY B-122  Female - Rigid	 Seal-Lok® (O-Ring Face Seal)	1J0HY B-122  Male - Rigid w/O-Ring	1JCHY B-122  Female - Swivel Short
1JSHY B-123  Female - Swivel Long	1J7HY B-123  Female - Swivel 45° Elbow	1J9HY B-124  Female - Swivel 90° Elbow - Short	1J1HY B-124  Female - Swivel 90° Elbow - Long	 Metric L & S	1D0HY B-125  Male - Rigid
13DHY B-125  Male Standpipe Rigid	 BSP	1D9HY B-125  Male - Rigid	1GUHY B-126  Female - Swivel	1UTHY B-126  Male - Rigid	1XUHY B-126  Female - Metric Swivel

101HY Male NPTF Pipe - Rigid

# Part Number	Thread inch	Hose I.D. inch	A		H inch	B		Additional Material Stainless Steel (C303)
			inch	mm		inch	mm	
101HY-2-4	1/8x27	1/4	2.34	59	5/8	1.00	25	
101HY-4-4	1/4x18	1/4	2.53	64	9/16	1.19	30	
101HY-4-5	1/4x18	5/16	2.56	65	11/16	1.22	31	
101HY-4-6	1/4x18	3/8	2.55	65	11/16	1.19	30	
101HY-6-4	3/8x18	1/4	2.53	64	3/4	1.19	30	
101HY-6-5	3/8x18	5/16	2.56	65	3/4	1.22	31	
101HY-6-6	3/8x18	3/8	2.55	65	3/4	1.19	30	•
101HY-6-8	3/8x18	1/2	2.72	69	7/8	1.38	35	
101HY-8-4	1/2x14	1/4	2.72	69	7/8	1.38	35	
101HY-8-6	1/2x14	3/8	2.73	69	7/8	1.38	35	
101HY-8-7	1/2x14	13/32	2.73	69	7/8	1.38	35	
101HY-8-8	1/2x14	1/2	2.91	74	7/8	1.41	40	•
101HY-8-10	1/2x14	5/8	2.94	75	1-1/8	1.59	40	
101HY-8-12	1/2x14	3/4	3.08	78	1-1/4	1.50	38	
101HY-12-8	3/4x14	1/2	2.91	74	1-1/16	1.56	40	
101HY-12-10	3/4x14	5/8	2.98	76	1-1/8	1.59	40	
101HY-12-12	3/4x14	3/4	3.08	78	1-1/4	1.50	38	•
101HY-12-16	3/4x14	1	3.23	82	1-3/8	1.63	41	
101HY-16-12	1x11-1/2	3/4	3.27	83	1-3/8	1.69	43	
101HY-16-14	1x11-1/2	7/8	3.27	83	1-3/8	1.78	43	
101HY-16-16	1x11-1/2	1	3.42	87	1-3/8	1.81	46	•
101HY-20-20	1-1/4x11-1/2	1-1/4	3.84	98	1-3/4	2.00	51	

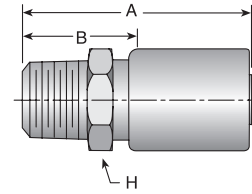

Stainless steel fittings must be assembled with Karrykrimp 2, Phastkrimp, Superkrimp or Parkrimp 2. See CrimpSource for more information.

113HY Male NPTF Pipe - Swivel

# Part Number	Thread inch	Hose I.D. inch	A		H inch	W inch	B	
			inch	mm			inch	mm
113HY-2-4	1/8x27	1/4	2.97	75	9/16	5/8	1.63	41
113HY-4-4	1/4x18	1/4	3.06	78	9/16	5/8	1.72	44
113HY-4-6	1/4x18	3/8	3.17	81	11/16	11/16	1.81	46
113HY-6-4	3/8x18	1/4	3.13	80	5/8	11/16	1.78	45
113HY-6-6	3/8x18	3/8	3.11	79	11/16	11/16	1.75	44
113HY-6-8	3/8x18	1/2	3.31	84	7/8	7/8	1.97	50
113HY-8-6	1/2x14	3/8	3.38	86	7/8	7/8	2.03	52
113HY-8-8	1/2x14	1/2	3.50	89	7/8	7/8	2.16	55
113HY-12-12	3/4x14	3/4	3.95	100	1-1/4	1-1/4	2.38	60
113HY-16-16	1x11-1/2	1	4.23	107	1-1/2	1-1/2	2.63	67

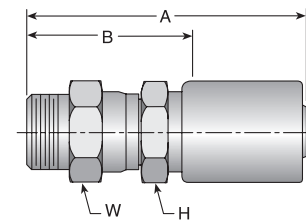

Fitting allows minor movement under pressure to relieve stress on hose but is not to be used for continuous swiveling. See Technical Section for Pressure Limitations.

Hose
A

Fittings HY Series
B

Equipment
C

Accessories
D

Technical
E

Hose
A

Fittings HY Series
B

Equipment
C

Accessories
D

Technical
E

11LHY

Male NPTF Pipe - Swivel - 90° Elbow

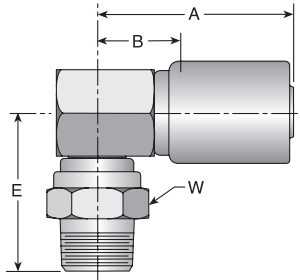

# Part Number	Thread inch	Hose I.D. inch	A		E		W		B	
			inch	mm	inch	mm	inch	inch	mm	
11LHY-2-4	1/8x27	1/4	2.31	59	1.50	38	5/8	0.97	25	
11LHY-4-4	1/4x18	1/4	2.31	59	1.69	43	11/16	0.97	25	
11LHY-4-6	1/4x18	3/8	2.33	59	1.69	43	11/16	0.97	25	
11LHY-6-4	3/8x18	1/4	2.31	59	1.63	41	11/16	0.97	25	
11LHY-6-6	3/8x8	3/8	2.33	59	1.63	41	11/16	0.97	25	
11LHY-8-6	1/2x14	3/8	2.73	69	1.88	48	7/8	0.97	25	
11LHY-8-8	1/2x14	1/2	3.00	76	1.93	49	7/8	1.09	28	

102HY

Female NPTF Pipe - Rigid

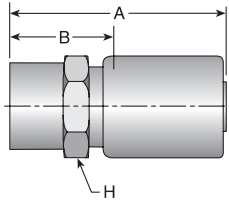

# Part Number	Thread inch	Hose I.D. inch	A		H	B	
			inch	mm	inch	inch	mm
102HY-2-4	1/8x27	1/4	2.34	59	5/8	1.00	25
102HY-4-4	1/4x18	1/4	2.47	63	11/16	1.13	29
102HY-4-6	1/4x18	3/8	2.48	63	11/16	1.13	29
102HY-6-4	3/8x18	1/4	2.47	63	7/8	1.13	29
102HY-6-6	3/8x18	3/8	2.48	63	7/8	1.13	29
102HY-8-6	1/2x14	3/8	2.75	70	1	1.41	36
102HY-8-8	1/2x14	1/2	2.84	72	1	1.50	38
102HY-12-12	3/4x14	3/4	2.83	72	1-1/4	1.25	32
102HY-16-16	1x11-1/2	1	3.27	83	1-1/2	1.66	42

107HY

Female NPSM Pipe - Swivel - (60° Cone)

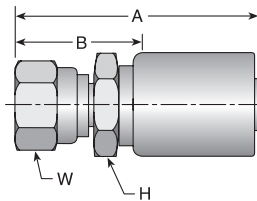

# Part Number	Thread inch	Hose I.D. inch	A		H	W	B	
			inch	mm	inch	inch	inch	mm
107HY-4-4	1/4x18	1/4	2.66	68	9/16	11/16	1.31	33
107HY-6-4	3/8x18	1/4	2.72	69	3/4	7/8	1.38	35
107HY-6-6	3/8x18	3/8	2.55	65	3/4	7/8	1.19	30
107HY-8-8	1/2x14	1/2	2.91	74	1	1	1.56	40
107HY-12-8	3/4x14	1/2	3.05	77	1-1/4	1-1/4	1.69	43
107HY-12-12	3/4x14	3/4	3.22	82	1-1/4	1-1/4	1.66	42
107HY-16-16	1x11-1/2	1	3.39	86	1-3/8	1-1/2	1.78	45

105HY

Male SAE Straight Thread with O-Ring - Rigid

# Part Number	Thread inch	Hose I.D. inch	A		H inch	B	
			inch	mm		inch	mm
105HY-4-4	7/16x20	1/4	2.33	59	9/16	0.97	25
105HY-5-4	1/2x20	1/4	2.33	59	5/8	0.97	25
105HY-6-4	9/16x18	1/4	2.42	61	11/16	1.06	27
105HY-6-6	9/16x18	3/8	2.38	60	11/16	1.03	26
105HY-8-6	3/4x16	3/8	2.42	61	7/8	1.06	27
105HY-8-8	3/4x16	1/2	2.59	66	7/8	1.25	32
105HY-10-6	7/8x14	3/8	2.55	65	1	1.19	30
105HY-10-8	7/8x14	1/2	2.66	68	1	1.31	33
105HY-10-10	7/8x14	5/8	2.80	71	1-1/8	1.41	36
105HY-12-8	1-1/16x12	1/2	2.81	71	1-1/4	1.47	37
105HY-12-10	1-1/16x12	5/8	2.83	72	1-1/4	1.44	37
105HY-12-12	1-1/16x12	3/4	2.92	74	1-1/4	1.34	34
105HY-16-12	1-5/16x12	3/4	2.92	74	1-1/2	1.34	34
105HY-16-16	1-5/16x12	1	3.08	78	1-1/2	1.47	37

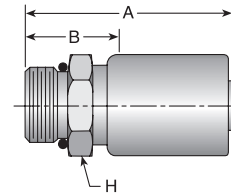

10GHY

Male SAE Straight Thread with O-Ring - Swivel

# Part Number	Thread inch	Hose I.D. inch	A		H inch	W inch	B	
			inch	mm			inch	mm
10GHY-4-4	7/16x20	1/4	3.00	76	9/16	5/8	1.66	42
10GHY-5-4	1/2x20	1/4	3.00	76	9/16	5/8	1.66	42
10GHY-6-4	9/16x18	1/4	3.16	80	5/8	11/16	1.81	46
10GHY-6-6	9/16x18	3/8	3.14	80	11/16	11/16	1.78	45
10GHY-8-6	3/4x16	3/8	3.24	82	13/16	7/8	1.88	48
10GHY-8-8	3/4x16	1/2	3.36	85	7/8	7/8	2.00	51
10GHY-10-8	7/8x14	1/2	3.44	87	1	1	2.09	53
10GHY-12-8	1-1/16x12	1/2	3.66	93	1-1/4	1-1/4	2.31	59
10GHY-12-12	1-1/16x12	3/4	3.89	99	1-1/4	1-1/4	2.31	59
10GHY-16-16	1-5/16x12	1	3.95	100	1-3/8	1-1/2	2.34	59

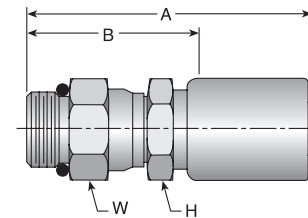

Fitting allows minor movement under pressure to relieve stress on hose but is not to be used on extensive or continuous swiveling.

O-Ring not compatible with Phosphate Ester fluids.

Hose
A

Fittings HY Series
B

Equipment
C

Accessories
D

Technical
E

10LHY

Male SAE Straight Thread with O-Ring - Swivel - 90° Elbow

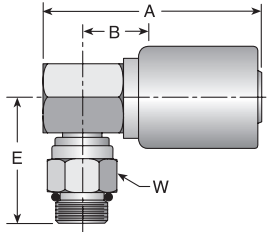

# Part Number	Thread inch	Hose I.D. inch	A		E		W		B	
			inch	mm	inch	mm	inch	inch	mm	
10LHY-4-4	7/16x20	1/4	2.31	59	1.63	41	11/16	0.97	25	
10LHY-6-4	9/16x18	1/4	2.31	59	1.66	42	7/8	0.97	25	
10LHY-6-6	9/16x18	3/8	2.33	59	1.66	42	11/16	0.97	25	
10LHY-8-4	3/4x16	1/4	2.31	59	1.75	44	7/8	0.94	24	
10LHY-8-6	3/4x16	3/8	2.33	59	1.73	44	7/8	0.97	25	
10LHY-8-8	3/4x16	1/2	3.00	76	1.80	46	7/8	1.09	28	
10LHY-10-8	7/8x14	1/2	3.00	76	1.88	48	1	1.09	28	
10LHY-12-12	1-1/16x12	3/4	2.77	70	2.23	57	1-1/4	1.19	30	

Fitting allows minor movement under pressure to relieve stress on hose but is not to be used on extensive or continuous swiveling.

103HY

Male JIC 37° - Rigid

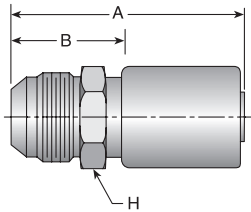

# Part Number	Thread inch	Hose I.D. inch	A		H inch	B	
			inch	mm		inch	mm
103HY-4-4	7/16x20	1/4	2.52	64	5/8	1.19	30
103HY-5-4	1/2x20	1/4	2.52	64	5/8	1.19	30
103HY-6-4	9/16x18	1/4	2.53	64	11/16	1.19	30
103HY-6-5	9/16x18	5/16	2.56	65	11/16	1.22	31
103HY-6-6	9/16x18	3/8	2.54	65	11/16	1.19	30
103HY-6-8	9/16x18	1/2	2.72	69	7/8	1.38	35
103HY-8-6	3/4x16	3/8	2.64	67	13/16	1.28	33
103HY-8-8	3/4x16	1/2	2.81	71	7/8	1.47	37
103HY-10-6	7/8x14	3/8	2.81	71	1	1.47	37
103HY-10-8	7/8x14	1/2	2.91	74	1	1.56	40
103HY-10-10	7/8x14	5/8	2.98	76	1-1/8	1.59	40
103HY-10-12	7/8x14	3/4	3.08	78	1-1/4	1.50	38
103HY-12-8	1-1/16x12	1/2	3.02	77	1-1/8	1.66	42
103HY-12-10	1-1/16x12	5/8	3.09	78	1-1/8	1.72	44
103HY-12-12	1-1/16x12	3/4	3.19	81	1-1/4	1.63	41
103HY-14-12	1-3/16x12	3/4	3.19	81	1-1/4	1.63	41
103HY-16-12	1-5/16x12	3/4	3.23	82	1-3/8	1.66	42
103HY-16-16	1-5/16x12	1	3.39	86	1-3/8	1.78	45
103HY-20-16	1-5/8x12	1	3.44	87	1-3/4	1.81	46
103HY-20-20	1-5/8x12	1-1/4	3.83	97	1-3/4	2.00	51

106HY
Female JIC 37° - Swivel

# Part Number	Thread inch	Hose I.D. inch	A		H	W	B		Additional Material Stainless Steel (C303)
			inch	mm	inch	inch	inch	mm	
106HY-3-4	3/8x24	1/4	2.58	66	9/16	1/2	1.22	31	
106HY-4-4	7/16x20	1/4	2.60	66	9/16	9/16	1.25	32	•
106HY-4-6	7/16x20	3/8	2.67	68	3/4	9/16	1.31	33	
106HY-5-4	1/2x20	1/4	2.65	67	9/16	5/8	1.31	33	
106HY-5-5	1/2x20	5/16	2.69	68	5/8	5/8	1.34	34	
106HY-5-6	1/2x20	3/8	2.73	69	3/4	5/8	1.38	35	
106HY-6-4	9/16x18	1/4	2.67	68	5/8	11/16	1.31	33	
106HY-6-5	9/16x18	5/16	2.70	69	5/8	11/16	1.34	34	
106HY-6-6	9/16x18	3/8	2.69	68	11/16	11/16	1.34	34	•
106HY-8-6	3/4x16	3/8	2.72	69	7/8	7/8	1.38	35	•
106HY-8-8	3/4x16	1/2	2.90	74	7/8	7/8	1.41	40	•
106HY-8-10	3/4x16	5/8	2.98	76	1-1/8	7/8	1.59	40	
106HY-8-12	3/4x16	3/4	3.08	78	1-1/4	7/8	1.53	39	
106HY-10-6	7/8x14	3/8	2.81	71	7/8	1	1.47	37	
106HY-10-8	7/8x14	1/2	2.98	76	1	1	1.63	41	
106HY-10-10	7/8x14	5/8	3.06	78	1-1/8	1	1.69	43	
106HY-10-12	7/8x14	3/4	3.16	80	1-1/4	1	1.59	40	
106HY-12-6	1-1/16x12	3/8	3.00	76	1-1/8	1-1/4	1.66	42	
106HY-12-8	1-1/16x12	1/2	3.05	77	1-1/8	1-1/4	1.69	43	
106HY-12-10	1-1/16x12	5/8	3.12	79	1-1/8	1-1/4	1.75	44	
106HY-12-12	1-1/16x12	3/4	3.22	82	1-1/4	1-1/4	1.66	42	•
106HY-12-16	1-1/16x12	1	3.38	86	1-3/8	1-1/4	1.75	44	
106HY-14-12	1-3/16x12	3/4	3.23	82	1-1/4	1 3/8	1.66	42	
106HY-16-12	1-5/16x12	3/4	3.30	84	1-3/8	1-1/2	1.72	44	
106HY-16-14	1-5/16x12	7/8	3.30	84	1-3/8	1-1/2	1.72	44	
106HY-16-16	1-5/16x12	1	3.45	88	1-3/8	1-1/2	1.84	47	•
106HY-16-20	1-5/16x12	1-1/4	3.84	98	1-3/4	1-1/2	2.00	51	
106HY-20-16	1-5/8x12	1	3.70	94	1-3/4	2	2.09	53	
106HY-20-20	1-5/8x12	1-1/4	4.09	104	2	2	2.25	57	

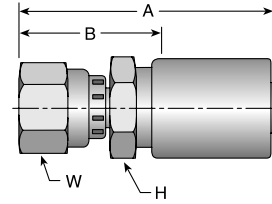

Stainless steel fittings must be assembled with Karrykrimp 2, PHastkrimp, Superkrimp or Parkrimp 2. See CrimpSource for more information.

Hose
A

Fittings HY Series
B

Equipment
C

Accessories
D

Technical
E

Hose
A

Fittings HY Series
B

Equipment
C

Accessories
D

Technical
E

137HY

Female JIC 37° - Swivel - 45° Elbow - Short Drop

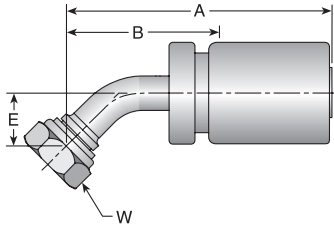

# Part Number	Thread inch	Hose I.D. inch	A		E		W		B	
			inch	mm	inch	mm	inch	inch	mm	
137HY-4-4	7/16x20	1/4	2.59	66	0.39	10	9/16	1.32	34	
137HY-5-4	1/2x20	1/4	3.27	83	0.36	9	5/8	1.91	49	
137HY-6-4	9/16x18	1/4	2.70	69	0.43	10	3/4	1.43	36	
137HY-6-5	9/16x18	5/16	3.34	85	0.39	11	11/16	2.00	51	
137HY-6-6	9/16x18	3/8	2.72	69	0.43	11	11/16	1.44	37	
137HY-8-6	3/4x16	3/8	2.88	73	0.58	15	7/8	1.60	41	
137HY-8-8	3/4x16	1/2	3.10	79	0.59	15	7/8	1.81	46	
137HY-10-8	7/8x14	1/2	3.20	81	0.63	16	1	1.91	49	
137HY-10-10	7/8x14	5/8	3.29	84	0.63	16	1	1.93	49	
137HY-12-10	1-1/16x12	5/8	3.94	100	0.77	20	1-1/8	2.56	65	
137HY-12-12	1-1/16x12	3/4	3.82	97	0.83	21	1-1/4	2.29	58	
137HY-16-12	1-5/16x12	3/4	4.35	110	0.89	23	1-1/2	2.78	71	
137HY-16-16	1-5/16x12	1	4.31	109	0.89	23	1-1/2	2.69	68	

139HY

Female JIC 37° - Swivel - 90° Elbow - Short Drop

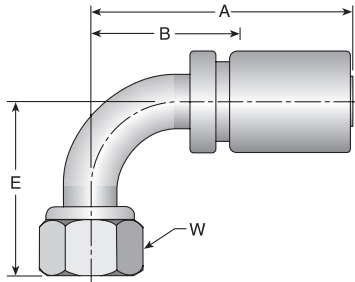

# Part Number	Thread inch	Hose I.D. inch	A		E		W		B	
			inch	mm	inch	mm	inch	inch	mm	
139HY-4-4	7/16x20	1/4	2.40	61	0.83	21	9/16	1.13	29	
139HY-5-4	1/2x20	1/4	2.50	64	0.83	21	5/8	1.23	31	
139HY-6-4	9/16x18	1/4	2.65	67	0.91	23	3/4	1.38	35	
139HY-6-5	9/16x18	5/16	3.25	83	0.86	22	11/16	1.91	49	
139HY-6-6	9/16x18	3/8	2.57	65	0.91	23	11/16	1.29	33	
139HY-6-8	9/16x18	1/2	3.41	87	0.86	22	11/16	2.06	52	
139HY-8-6	3/4x16	3/8	2.64	67	1.14	29	7/8	1.37	35	
139HY-8-8	3/4x16	1/2	2.85	72	1.14	29	7/8	1.56	40	
139HY-10-8	7/8x14	1/2	3.01	76	1.26	32	1	1.72	44	
139HY-10-10	7/8x14	5/8	3.09	78	1.26	32	1	1.73	44	
139HY-10-12	7/8x14	3/4	3.25	83	1.23	31	1	1.69	43	
139HY-12-8	1-1/16x12	1/2	3.61	92	1.83	46	1-1/4	2.25	57	
139HY-12-10	1-1/16x12	5/8	3.61	92	1.89	48	1-1/4	2.25	57	
139HY-12-12	1-1/16x12	3/4	3.68	93	1.89	48	1-1/4	2.15	55	
139HY-16-12	1-5/16x12	3/4	4.33	110	2.14	54	1-1/2	2.78	71	
139HY-16-16	1-5/16x12	1	4.31	109	2.31	59	1-1/2	2.69	68	

141HY

Female JIC 37° - Swivel - 90° Elbow - Long Drop

# Part Number	Thread inch	Hose I.D. inch	A		E		W inch	B	
			inch	mm	inch	mm		inch	mm
141HY-4-4	7/16x20	1/4	2.68	68	1.81	46	9/16	1.41	36
141HY-5-4	1/2x20	1/4	3.16	80	1.77	45	5/8	1.81	46
141HY-6-4	9/16x18	1/4	2.89	73	2.13	54	11/16	1.62	41
141HY-6-6	9/16x18	3/8	2.76	70	2.13	54	11/16	1.49	39
141HY-8-6	3/4x16	3/8	2.85	72	2.52	64	7/8	1.58	40
141HY-8-8	3/4x16	1/2	2.89	73	2.52	64	7/8	1.60	41
141HY-10-8	7/8x14	1/2	3.01	76	2.76	70	1	1.72	44
141HY-12-12	1-1/16x12	3/4	3.59	91	3.73	95	1-1/4	2.03	52
141HY-16-16	1-5/16x12	1	4.56	116	4.33	110	1-1/2	2.94	75

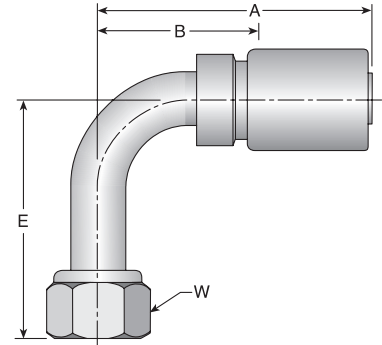

193HY

Female JIC 37° - Swivel - 90° Elbow - (Block Type)

# Part Number	Thread inch	Hose I.D. inch	A		E		W inch	B	
			inch	mm	inch	mm		inch	mm
193HY-6-6	9/16x18	3/8	2.33	59	0.78	20	11/16	0.97	25
193HY-8-6	3/4x16	3/8	2.33	59	0.82	21	7/8	0.97	25
193HY-8-8	3/4x16	1/2	3.00	76	0.85	22	7/8	1.09	28
193HY-12-12	1-1/16x12	3/4	3.33	85	0.99	25	1-1/4	1.19	30

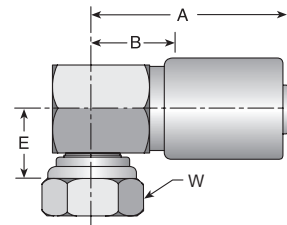

108HY

Female SAE 45° - Swivel

# Part Number	Thread inch	Hose I.D. inch	A		H inch	W inch	B	
			inch	mm			inch	mm
108HY-4-4	7/16x20	1/4	2.60	66	9/16	9/16	1.26	32
108HY-5-4	1/2x20	1/4	2.66	68	9/16	5/8	1.31	33
108HY-5-5	1/2x20	5/16	2.68	68	5/8	5/8	1.34	34
108HY-6-4	5/8x18	1/4	2.73	69	11/16	3/4	1.38	35
108HY-6-5	5/8x18	5/16	2.76	70	5/8	3/4	1.41	36
108HY-6-6	5/8x18	3/8	2.75	70	11/16	3/4	1.41	36
108HY-8-6	3/4x16	3/8	2.73	69	13/16	7/8	1.38	35
108HY-8-8	3/4x16	1/2	2.90	74	7/8	7/8	1.56	40
108HY-8-12	3/4x16	3/4	3.17	81	1-1/4	7/8	1.59	40
108HY-10-8	7/8x14	1/2	2.98	76	1	1	1.63	41
108HY-10-10	7/8x14	5/8	3.06	78	1-1/8	1	1.69	43
108HY-12-10	1-1/16x12	5/8	3.33	85	1-1/8	1-1/4	1.94	49
108HY-12-12	1-1/16x12	3/4	3.41	87	1-1/4	1-1/4	1.84	47

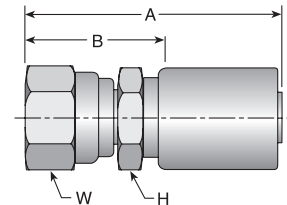

Hose
A

Fittings HY Series
B

Equipment
C

Accessories
D

Technical
E

Hose
A

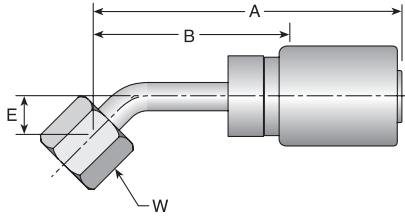

177HY

Female SAE 45° - Swivel - 45° Elbow

# Part Number	Thread inch	Hose I.D. inch	A		E		W		B	
			inch	mm	inch	mm	inch	inch	mm	
177HY-6-6	5/8x18	3/8	3.33	85	0.39	10	3/4	1.97	50	
177HY-12-12	1-1/16x14	3/4	4.03	102	0.77	20	1-1/4	2.44	62	

Fittings HY Series
B

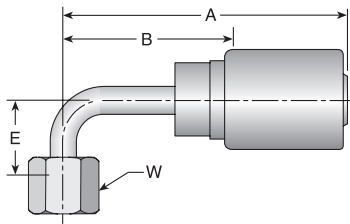

179HY

Female SAE 45° - Swivel - 90° Elbow

# Part Number	Thread inch	Hose I.D. inch	A		E		W		B	
			inch	mm	inch	mm	inch	inch	mm	
179HY-6-5	5/8x18	5/16	3.25	83	0.86	22	3/4	1.91	49	
179HY-6-6	5/8x18	3/8	3.23	82	0.86	22	3/4	1.88	48	
179HY-12-12	1-1/16x14	3/4	3.98	101	1.83	46	1-1/4	2.39	61	

Equipment
C

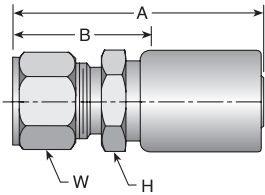

111HY

Male Ferulok Flareless - Rigid
(24° Cone w/Nut and Ferrule)

# Part Number	Thread inch	Hose I.D. inch	A		H		W		B	
			inch	mm	inch	inch	inch	inch	mm	
111HY-4-4	7/16x20	1/4	2.42	61	9/16	9/16	1.06	27		
111HY-4-6	7/16x20	3/8	2.44	62	3/4	9/16	1.09	28		
111HY-5-6	1/2x20	3/8	2.44	62	3/4	5/8	1.09	28		
111HY-6-4	9/16x18	1/4	2.44	62	5/8	11/16	1.09	28		
111HY-6-6	9/16x18	3/8	2.45	62	11/16	11/16	1.09	28		
111HY-8-6	3/4x16	3/8	2.61	66	7/8	7/8	1.25	32		
111HY-8-8	3/4x16	1/2	2.72	69	7/8	7/8	1.38	35		
111HY-10-8	7/8x14	1/2	2.78	71	1	1	1.44	37		
111HY-12-12	1-1/16x12	3/4	3.02	77	1-1/4	1-1/4	1.44	37		

The Parker Ferrule-Fix fitting makes it possible to salvage the bent tube section from a hose assembly for quick, easy on the job repairs. For additional information see Ferrule-Fix installation instructions in the Technical Section.

Accessories
D

1GJHY

Female Grease Connection - SPL - PTF Taper
Thread - Rigid - 1/2x27

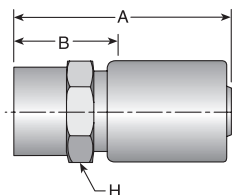

# Part Number	Thread inch	Hose I.D. inch	A		H		B	
			inch	mm	inch	inch	mm	
1GJHY-8-4	1/2x27	1/4	2.41	61	3/4	1.06	27	

Technical
E

134HY

Male Standpipe - Rigid - (Inch Size Tube O.D.)

# Part Number	R inch	Hose I.D. inch	A		B	
			inch	mm	inch	mm
134HY-6-6	3/8	3/8	3.17	81	1.81	46
134HY-8-6	1/2	3/8	3.33	85	1.97	50
134HY-12-12	3/4	3/4	3.89	99	2.31	59

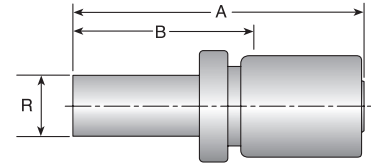

128HY

Male Inverted SAE 45° - Swivel

# Part Number	Thread inch	Hose I.D. inch	A		W inch	B	
			inch	mm		inch	mm
128HY-3-4	3/8x24	1/4	3.09	78	3/8	1.75	44
128HY-4-4	7/16x24	1/4	3.28	83	7/16	1.94	49
128HY-5-4	1/2x20	1/4	3.34	85	1/2	2.00	51
128HY-5-6	1/2x20	3/8	3.17	81	1/2	1.81	46
128HY-6-5	5/8x18	5/16	3.75	95	5/8	2.41	61
128HY-6-6	5/8x18	3/8	3.73	95	5/8	2.38	60
128HY-7-6	11/16x18	3/8	3.73	95	11/16	2.38	60
128HY-8-6	3/4x18	3/8	3.42	87	3/4	2.06	52
128HY-8-8	3/4x18	1/2	3.66	93	3/4	2.31	59

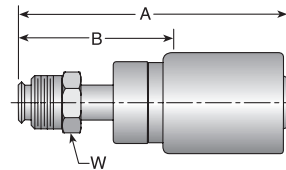

167HY

Male Inverted SAE 45° - Swivel - 45° Elbow

# Part Number	Thread inch	Hose I.D. inch	A		E		W inch	B	
			inch	mm	inch	mm		inch	mm
167HY-4-4	7/16x24	1/4	3.31	84	0.78	20	7/16	1.97	50
167HY-5-4	1/2x20	1/4	3.55	90	0.88	22	1/2	2.19	56
167HY-5-6	1/2x20	3/8	3.38	86	0.88	22	1/2	2.03	52
167HY-6-6	5/8x18	3/8	4.16	106	0.94	24	5/8	2.81	71
167HY-8-8	3/4x18	1/2	4.22	107	1.06	27	3/4	2.88	73

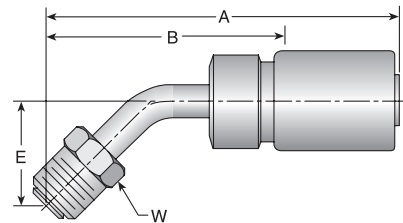

Hose
A

Fittings HY Series
B

Equipment
C

Accessories
D

Technical
E

Hose
A

Fittings HY Series
B

Equipment
C

Accessories
D

Technical
E

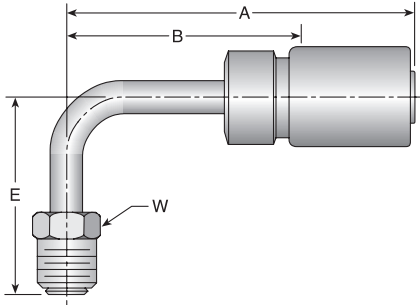

169HY

Male Inverted SAE 45° - Swivel - 90° Elbow

# Part Number	Thread inch	Hose I.D. inch	A		E		W inch	B	
			inch	mm	inch	mm		inch	mm
169HY-3-4	3/8x24	1/4	3.09	78	1.38	35	3/8	1.75	44
169HY-4-4	7/16x24	1/4	3.28	83	1.47	37	7/16	1.94	49
169HY-4-6	7/16x24	3/8	3.11	79	1.47	37	7/16	1.75	44
169HY-5-4	1/2x20	1/4	3.52	89	1.66	42	1/2	2.16	55
169HY-5-6	1/2x20	3/8	3.34	85	1.66	42	1/2	2.00	51
169HY-6-5	5/8x18	5/16	4.05	103	1.69	43	5/8	2.69	68
169HY-6-6	5/8x18	3/8	4.03	102	1.69	43	5/8	2.69	68
169HY-7-6	11/16x18	3/8	4.16	106	1.69	43	11/16	2.81	71
169HY-8-8	3/4x18	1/2	4.09	104	1.88	48	3/4	2.75	70

129HY

Female Inverted SAE 45° - Rigid

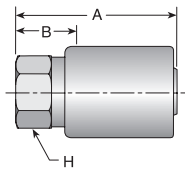

# Part Number	Thread inch	Hose I.D. inch	A		H inch	B	
			inch	mm		inch	mm
129HY-5-4	1/2x20	1/4	2.25	57	5/8	0.91	23
129HY-6-6	5/8x18	3/8	2.25	57	7/8	0.91	23

1J0HY

Male Seal-Lok® - Rigid - (with O-Ring)
ISO 1215-1 - S

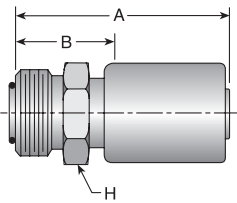

# Part Number	Thread inch	Hose I.D. inch	A		H inch	B	
			inch	mm		inch	mm
1J0HY-4-4	9/16x18	1/4	2.36	60	5/8	1.00	25
1J0HY-6-6	11/16x16	3/8	2.49	63	3/4	1.13	29
1J0HY-8-8	13/16x16	1/2	2.69	68	7/8	1.34	34
1J0HY-12-8	1-3/16x12	1/2	2.91	74	1-1/4	1.56	40

1JCHY

Female Seal-Lok® - Swivel - Short
ISO 12151-1 - SWSA

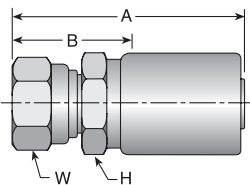

# Part Number	Thread inch	Hose I.D. inch	A		H inch	W inch	B	
			inch	mm			inch	mm
1JCHY-4-4	9/16x18	1/4	2.61	66	9/16	11/16	0.94	24
1JCHY-6-6	11/16x16	3/8	2.69	68	11/16	13/16	0.94	24
1JCHY-8-8	13/16x16	1/2	2.91	74	7/8	15/16	1.13	29
1JCHY-12-12	1-3/16x12	3/4	3.31	84	1-1/4	1-3/8	1.13	29

See Accessories for O-Rings.

1JSHY

Female Seal-Lok® - Swivel - Long
ISO 12151-1 - SWSB

# Part Number	Thread inch	Hose I.D. inch	A		H inch	W inch	B	
			inch	mm			inch	mm
1JSHY-4-4	9/16x18	1/4	2.59	66	9/16	11/16	1.25	32
1JSHY-6-4	11/16x16	1/4	2.67	68	5/8	13/16	1.31	33
1JSHY-6-5	11/16x16	5/16	2.70	69	5/8	13/16	1.34	34
1JSHY-6-6	11/16x16	3/8	2.75	70	11/16	13/16	1.34	34
1JSHY-8-6	13/16x16	3/8	2.84	72	7/8	15/16	1.50	38
1JSHY-8-8	13/16x16	1/2	2.95	75	7/8	15/16	1.59	40
1JSHY-10-8	1x14	1/2	3.16	80	15/16	1-1/8	1.81	46
1JSHY-10-10	1x14	5/8	3.17	81	1-1/8	1-1/8	1.78	45
1JSHY-10-12	1x14	3/4	3.27	83	1-1/4	1-1/8	1.69	43
1JSHY-12-10	1-3/16x12	5/8	3.20	81	1-1/8	1-3/8	1.81	46
1JSHY-12-12	1-3/16x12	3/4	3.30	84	1-1/4	1-3/8	1.72	44
1JSHY-16-12	1-7/16x12	3/4	3.44	87	1-3/8	1-5/8	1.88	48
1JSHY-16-16	1-7/16x12	1	3.59	91	1-3/8	1-5/8	1.97	50
1JSHY-20-16	1-11/16x12	1	3.47	88	1-5/8	1-7/8	1.75	59
1JSHY-20-20	1-11/16x12	1-1/4	3.98	101	1-3/4	1-7/8	2.16	55

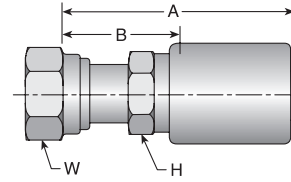

1J7HY

Female Seal-Lok® - Swivel - 45° Elbow
ISO 12151-1 - SWE45

# Part Number	Thread inch	Hose I.D. inch	A		E		W inch	B	
			inch	mm	inch	mm		inch	mm
1J7HY-4-4	9/16x18	1/4	2.59	66	0.39	10	11/16	1.32	34
1J7HY-6-4	11/16x16	1/4	2.70	69	0.43	11	13/16	1.43	36
1J7HY-6-6	11/16x16	3/8	2.72	69	0.43	11	13/16	1.44	37
1J7HY-6-8	11/16x16	1/2	3.41	87	0.44	11	13/16	2.06	52
1J7HY-8-4	13/16x16	1/4	2.95	75	0.59	15	15/16	1.68	43
1J7HY-8-6	13/16x16	3/8	2.89	73	0.59	15	15/16	1.62	41
1J7HY-8-8	13/16x16	1/2	3.10	79	0.59	15	15/16	1.81	46
1J7HY-10-8	1x14	1/2	3.20	81	0.63	16	1-1/8	1.91	49
1J7HY-10-10	1x14	5/8	3.29	84	0.63	16	1-1/8	1.93	49
1J7HY-10-12	1x14	3/4	3.69	94	0.69	18	1-1/8	2.13	54
1J7HY-12-10	1-3/16x12	5/8	3.74	104	0.83	21	1-3/8	2.38	60
1J7HY-12-12	1-3/16x12	3/4	3.82	97	0.83	21	1-3/8	2.29	58
1J7HY-16-12	1-7/16x12	3/4	4.39	112	0.97	25	1-5/8	2.84	72
1J7HY-16-16	1-7/16x12	1	4.55	116	0.97	25	1-5/8	2.94	75

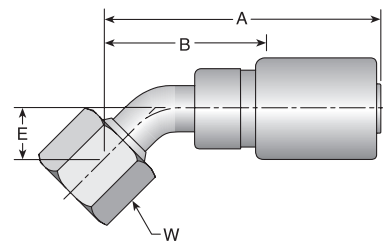

See Accessories for O-Rings.

Hose
A

Fittings HY Series
B

Equipment
C

Accessories
D

Technical
E

1J9HY

Female Seal-Lok® - Swivel - 90° Elbow - Short Drop
ISO 12151-1 - SWES90

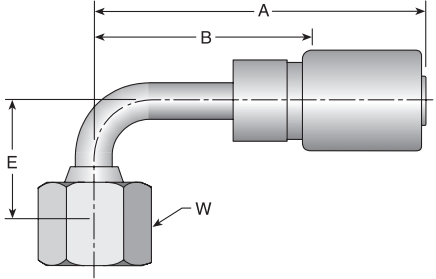

# Part Number	Thread inch	Hose I.D. inch	A		E		W		B	
			inch	mm	inch	mm	inch	inch	mm	
1J9HY-4-4	9/16x18	1/4	2.40	61	0.83	21	11/16	1.13	29	
1J9HY-4-6	9/16x18	3/8	3.08	78	0.83	21	11/16	1.72	44	
1J9HY-6-4	11/16x16	1/4	2.65	67	0.91	23	13/16	1.38	35	
1J9HY-6-5	11/16x16	5/16	3/14	80		23	13/16	1.72	44	
1J9HY-6-6	11/16x16	3/8	2.57	65	0.91	23	13/16	1.29	33	
1J9HY-6-8	11/16x16	1/2	2.77	70	0.91	23	13/16	1.48	38	
1J9HY-8-6	13/16x16	3/8	2.64	67	1.14	29	15/16	1.37	35	
1J9HY-8-8	13/16x16	1/2	2.85	72	1.14	29	15/16	1.56	40	
1J9HY-10-8	1x14	1/2	3.01	76	1.26	32	1-1/8	1.72	44	
1J9HY-10-10	1x14	5/8	3.09	78	1.26	32	1-1/8	1.73	44	
1J9HY-10-12	1x14	3/4	3.52	89	1.33	34	1-1/8	1.97	50	
1J9HY-12-8	1-3/16x12	1/2	3.84	98	1.89	48	1-3/8	2.39	61	
1J9HY-12-10	1-3/16x12	5/8	3.61	92	1.89	48	1-3/8	2.25	57	
1J9HY-12-12	1-3/16x12	3/4	3.68	93	1.89	48	1-3/8	2.15	55	
1J9HY-16-12	1-7/16x12	3/4	4.27	108	2.25	57	1-5/8	2.69	68	
1J9HY-16-16	1-7/16x12	1	4.45	113	2.25	57	1-5/8	2.84	72	
1J9HY-20-16	1-11/16x12	1	4.77	121	2.51	64	1-7/8	3.16	80	

1J1HY

Female Seal-Lok® - Swivel - 90° Elbow - Long Drop
ISO 12151-1 - SWEL90

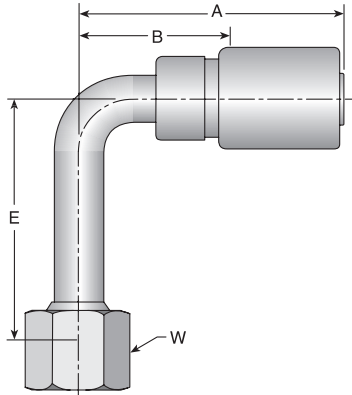

# Part Number	Thread inch	Hose I.D. inch	A		E		W		B	
			inch	mm	inch	mm	inch	inch	mm	
1J1HY-4-4	9/16x18	1/4	2.68	68	1.81	46	11/16	1.41	36	
1J1HY-6-4	11/16x16	1/4	2.89	73	2.13	54	13/16	1.62	41	
1J1HY-6-6	11/16x16	3/8	2.76	70	2.13	54	13/16	1.49	38	
1J1HY-8-6	13/16x16	3/8	2.85	72	2.52	64	15/16	1.58	40	
1J1HY-8-8	13/16x16	1/2	2.94	75	2.52	64	15/16	1.65	42	
1J1HY-10-8	1x14	1/2	3.01	76	2.76	70	1-1/8	1.72	44	
1J1HY-10-10	1x14	5/8	3.42	87	3.83	70	1-1/8	2.03	52	
1J1HY-12-12	1-3/16x12	3/4	3.68	93	3.78	96	1-3/8	2.15	55	
1J1HY-16-16	1-7/16x12	1	4.45	113	4.50	114	1-5/8	2.84	72	

See Accessories for O-Rings.

1D0HY

Male Metric L - Rigid - (24° Cone)

ISO 8434-1

# Part Number	Thread		Hose I.D. inch	A		H mm	B	
	mm	M		inch	mm		inch	mm
1D0HY-6-4	6	M12x1.5	1/4	2.36	60	14	1.00	25
1D0HY-8-4	8	M14x1.5	1/4	2.36	60	17	1.00	25
1D0HY-10-4	10	M16x1.5	1/4	2.40	61	19	1.03	26
1D0HY-10-6	10	M16x1.5	3/8	2.42	61	19	1.06	27
1D0HY-12-6	12	M18x1.5	3/8	2.42	61	22	1.06	27
1D0HY-15-6	15	M22x1.5	3/8	2.52	64	24	1.16	29
1D0HY-15-8	15	M22x1.5	1/2	2.63	67	24	1.28	33
1D0HY-18-10	18	M26x1.5	5/8	2.71	69	27	1.31	33

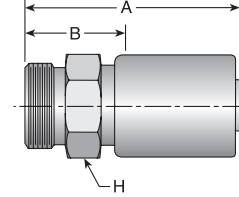

13DHY

Male Standpipe Metric S - Rigid

ISO 8434-1

# Part Number	R	Hose I.D. inch	A		B	
	mm		inch	mm	inch	mm
13DHY-16-8	16	1/2	3.53	90	2.16	55
13DHY-30-16	30	1	4.15	105	2.53	64

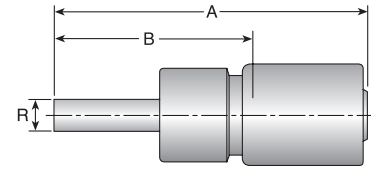

1D9HY

Male BSP Parallel Pipe - Rigid - (60° Cone)

ISO 228-1

# Part Number	Thread	Hose I.D. inch	A		H inch	B	
	inch		inch	mm		inch	mm
1D9HY-4-4	1/4x19	1/4	2.40	61	13/16	1.03	26
1D9HY-6-6	3/8x19	3/8	2.55	65	7/8	1.19	30
1D9HY-8-6	1/2x14	3/8	2.65	67	1-1/16	1.28	33
1D9HY-8-8	1/2x14	1/2	2.83	72	1-1/16	1.47	37

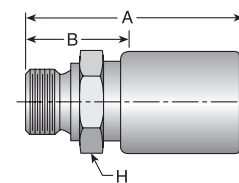

When used in a port, a bonded seal must be used. See Accessories Section for more information.

Metric L: Mates with EO "L" Series Fittings.
Metric S: Mates with EO "S" Series Fittings.

Hose
A

Fittings HY Series
B

Equipment
C

Accessories
D

Technical
E

1GUHY

Female BSP Parallel Pipe - Swivel - (60° Cone)
ISO 228-1

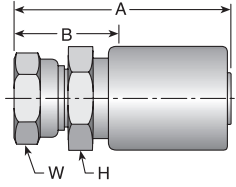

# Part Number	Thread inch	Hose I.D. inch	A		H	W	B	
			inch	mm	inch	inch	inch	mm
1GUHY-4-4	1/4x19	1/4	2.62	67	9/16	11/16	1.28	33
1GUHY-6-4	3/8x19	1/4	2.69	68	3/4	7/8	1.34	34
1GUHY-6-6	3/8x19	3/8	2.70	69	3/4	7/8	1.34	34
1GUHY-8-6	1/2x14	3/8	2.84	72	7/8	1	1.50	38
1GUHY-8-8	1/2x14	1/2	3.02	77	7/8	1	1.66	42
1GUHY-12-12	3/4x14	3/4	3.25	83	1-1/4	1-1/4	1.69	43
1GUHY-16-16	1x11	1	3.45	88	1-3/8	1-1/2	1.84	47

1UTHY

Male BSP Taper Pipe - Rigid - (60° Cone)

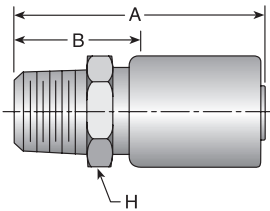







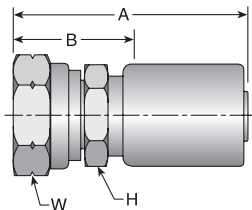



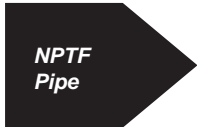
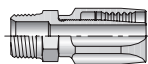

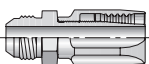
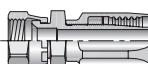
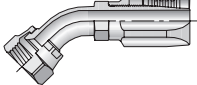
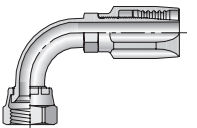
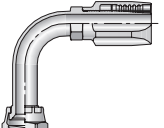

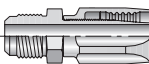
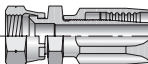
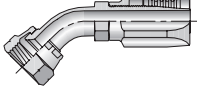
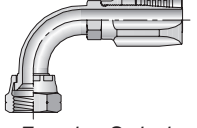

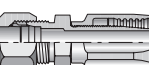

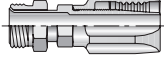
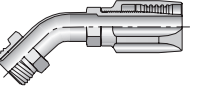
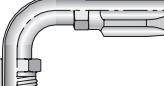
# Part Number	Thread inch	Hose I.D. inch	A		H	B	
			inch	mm	inch	inch	mm
1UTHY-2-4	1/8x28	1/4	2.34	59	9/16	1.00	25
1UTHY-4-4	1/4x19	1/4	2.53	64	9/16	1.19	30

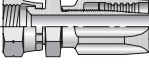
1XUHY

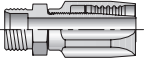
Female Metric Swivel - (30° Flare)

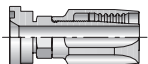
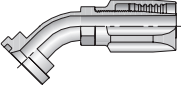
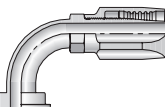

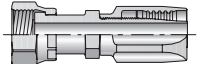
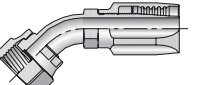
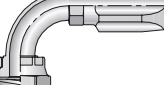
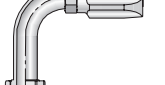
# Part Number	Thread mm		Hose I.D. inch	A		H	W	B	
	mm	mm		inch	mm	mm	mm	inch	mm
1XUHY-24-8	24	M24x1.5	1/2	3.14	80	22	30	1.72	44
1XUHY-24-10	24	M24x1.5	5/8	3.22	82	30	30	1.84	47
1XUHY-30-12	30	M30x1.5	3/4	3.31	84	32	38	1.75	44
1XUHY-33-16	33	M33x1.5	1	3.62	92	36	41	2.00	51

	20120 B-128  Male - Rigid		20320 B-128  Male - Rigid	20620 B-129  Female - Swivel	23720 B-129  Female - Swivel 45° Elbow - Short
23920 B-130  Female - Swivel 90° Elbow - Short	24120 B-130  Female - Swivel 90° Elbow - Long		20420 B-130  Male - Rigid	20820 B-131  Female - Swivel	27720 B-131  Female - Swivel 45° Elbow
27920 B-131  Female - Swivel 90° Elbow	28120 B-132  Female - Swivel 90° Elbow - Long		21120 B-132  Male - Rigid		22820 B-132  Male - Swivel
26720 B-132  Male - Swivel 45° Elbow	26920 B-133  Male - Swivel 90° Elbow		23220 B-133  Female - Swivel		26120 B-133  Male (without Nut or Sleeve)
	21520 B-133  Flange	21720 B-134  45° Elbow	21920 B-134  90° Elbow		2JS20 B-134  Female - Swivel Long
2J720 B-134  Female - Swivel 45° Elbow	2J920 B-135  Female - Swivel 90° Elbow - Short	2J120 B-135  Female - Swivel 90° Elbow - Long		20 Series Assembly Instructions B-136	

Hose
A

Fittings 20 Series
B

Equipment
C

Accessories
D

Technical
E

20120

Male NPTF Pipe - Rigid

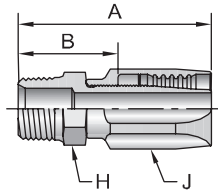

# Part Number	Thread		Hose I.D. inch	A		H		J		Additional Material Brass (B)
	inch			inch	mm	inch	inch	inch	mm	
20120-2-4	1/8x27		3/16	1.72	44	7/16	5/8	0.94	24	
20120-2-5	1/8x27		1/4	1.82	46	1/2	11/16	0.99	25	
20120-4-4	1/4x18		3/16	1.93	49	9/16	5/8	1.15	29	
20120-4-5	1/4x18		1/4	2.01	51	9/16	11/16	1.18	30	
20120-4-6	1/4x18		5/16	2.11	54	9/16	13/16	1.19	30	
20120-6-6	3/8x18		5/16	2.20	56	3/4	13/16	1.28	33	
20120-6-8	3/8x18		13/32	2.48	63	3/4	15/16	1.39	35	
20120-8-8	1/2x14		13/32	2.73	69	7/8	15/16	1.64	42	
20120-8-10	1/2x14		1/2	2.88	73	7/8	1-1/8	1.66	42	
20120-12-10	3/4x14		1/2	2.95	75	1-1/16	1-1/8	1.73	44	
20120-12-12	3/4x14		5/8	3.25	83	1-1/16	1-1/4	1.75	44	
20120-12-16	3/4x14		7/8	2.81	71	1-3/8	1-7/16	1.62	41	
20120-16-16	1x11-1/2		7/8	2.99	76	1-3/8	1-7/16	1.80	46	•
20120-20-20	1-1/4x11-1/2		1-1/8	3.24	82	1-3/4	1-3/4	1.96	50	•
20120-24-24	1-1/2x11-1/2		1-3/8	3.50	89	2	2	2.13	54	•
20120-32-32	2 x11-1/2		1-13/16	4.05	103	2-1/2	2-1/2	2.31	59	•

20320

Male JIC 37° - Rigid

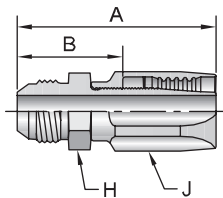

# Part Number	Thread		Hose I.D. inch	A		H		J	
	inch			inch	mm	inch	inch	inch	mm
20320-4-4	1/4	7/16x20	3/16	1.83	46	1/2	5/8	1.05	27
20320-5-5	5/16	1/2x20	1/4	1.94	49	9/16	11/16	1.11	28
20320-6-6	3/8	9/16x18	5/16	2.11	54	5/8	13/16	1.19	30
20320-8-8	1/2	3/4x16	13/32	2.57	65	13/16	15/16	1.48	38
20320-10-10	5/8	7/8x14	1/2	2.88	73	15/16	1-1/8	1.66	42
20320-12-12	3/4	1-1/16x12	5/8	3.35	85	1-1/8	1-1/4	1.85	47
20320-16-16	1	1-5/16x12	7/8	2.95	75	1-3/8	1-7/16	1.76	45

20620

Female JIC 37° - Swivel

# Part Number	Thread		Hose I.D. inch	A		H inch	J inch	W inch	B		Additional Material Stainless Steel (C)
	inch	inch		inch	mm				inch	mm	
20620-4-4	1/4	7/16x20	3/16	1.94	49	9/16	5/8	9/16	1.16	29	•
20620-4-5	1/4	7/16x20	1/4	2.04	52	9/16	11/16	9/16	1.21	31	
20620-5-5	5/16	1/2x20	1/4	2.12	54	5/8	11/16	5/8	1.29	33	
20620-6-5	3/8	9/16x18	1/4	2.19	56	11/16	11/16	11/16	1.36	35	
20620-6-6	3/8	9/16x18	5/16	2.32	59	11/16	13/16	11/16	1.40	36	•
20620-8-6	1/2	3/4x16	5/16	2.44	62	7/8	13/16	7/8	1.52	39	
20620-8-8	1/2	3/4x16	13/32	2.79	71	7/8	15/16	7/8	1.70	43	•
20620-8-10	1/2	3/4x16	1/2	2.99	76	7/8	1-1/8	7/8	1.77	45	
20620-10-8	5/8	7/8x14	13/32	2.94	75	7/8	15/16	1	1.85	47	
20620-10-10	5/8	7/8x14	1/2	3.10	79	1	1-1/8	1	1.88	48	•
20620-10-12	5/8	7/8x14	5/8	3.40	86	1	1-1/4	1	1.90	48	
20620-12-12	3/4	1-1/16x12	5/8	3.49	89	1-1/4	1-1/4	1-1/4	1.99	51	•
20620-16-16	1	1-5/16x12	7/8	3.20	81	1-1/2	1-7/16	1-1/2	2.01	51	•
20620-20-20	1-1/4	1-5/8x12	1-1/8	3.56	90	2	1-3/4	2	2.28	58	
20620-24-24	1-1/2	1-7/8x12	1-3/8	3.95	100	2-1/4	2	2-1/4	2.58	66	
20620-32-32	2	2-1/2x12	1-13/16	4.71	120	2-7/8	2-1/2	2-7/8	2.97	75	

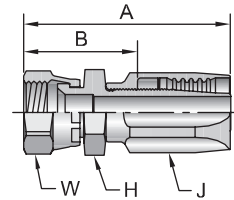

23720

Female JIC 37° - Swivel - 45° Elbow - Short Drop

# Part Number	Thread		Hose I.D. inch	A		E		H inch	J inch	W inch	B	
	inch	inch		inch	mm	inch	mm				inch	mm
23720-4-4	1/4	7/16x20	3/16	2.08	53	0.33	8	3/8	5/8	9/16	1.30	33
23720-5-5	5/16	1/2x20	1/4	2.30	58	0.36	9	7/16	11/16	5/8	1.47	37
23720-6-6	3/8	9/16x18	5/16	2.45	62	0.39	10	1/2	13/16	11/16	1.53	39
23720-8-6	1/2	3/4x16	5/16	2.77	70	0.55	14	5/8	13/16	7/8	1.85	47
23720-10-10	5/8	7/8x14	1/2	3.36	85	0.65	17	3/4	1-1/8	1	2.14	54
23720-12-12	3/4	1-1/16x12	5/8	3.94	100	0.79	20	7/8	1-1/4	1-1/4	2.44	62
23720-16-16	1	1-5/16x12	7/8	3.73	95	0.90	23	1-1/8	1-7/16	1-1/2	2.54	65
23720-20-20	1-1/4	1-5/8x12	1-1/8	4.17	106	1.19	30	1-1/2	1-3/4	2	2.89	73

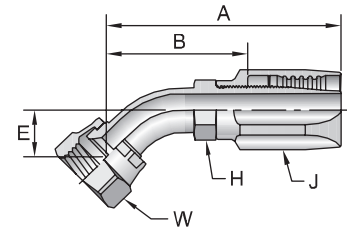

Hose
A

Fittings 20 Series
B

Equipment
C

Accessories
D

Technical
E

Hose
A

Fittings 20 Series
B

Equipment
C

Accessories
D

Technical
E

23920

Female JIC 37° - Swivel - 90° Elbow - Short Drop

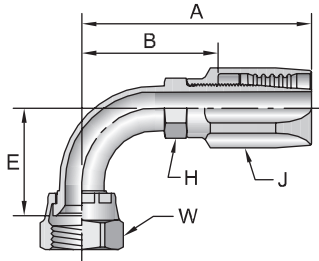

# Part Number	Thread		Hose I.D. inch	A		E		H inch	J inch	W inch	B	
	inch			inch	mm	inch	mm				inch	mm
23920-4-4	1/4	7/16x20	3/16	1.91	49	0.83	21	3/8	5/8	9/16	1.13	29
23920-5-5	5/16	1/2x20	1/4	2.30	58	0.77	20	7/16	11/16	5/8	1.47	37
23920-6-6	3/8	9/16x18	5/16	2.35	60	0.90	23	1/2	13/16	11/16	1.43	36
23920-8-8	1/2	3/4x16	13/32	2.88	73	1.09	28	5/8	15/16	7/8	1.79	45
23920-10-10	5/8	7/8x14	1/2	3.20	81	1.24	31	3/4	1-1/8	1	1.98	50
23920-12-12	3/4	1-1/16x12	5/8	3.86	98	1.82	46	7/8	1-1/4	1-1/4	2.36	60
23920-16-16	1	1-5/16x12	7/8	3.69	94	2.14	54	1-1/8	1-7/16	1-1/2	2.50	64
23920-20-20	1-1/4	1-5/8x12	1-1/8	4.01	102	2.59	66	1-1/2	1-3/4	2	2.73	69
23920-24-24	1-1/2	1-7/8x12	1-3/8	4.43	113	2.82	72	1-3/4	2	2-1/4	3.06	78

24120

Female JIC 37° - Swivel - 90° Elbow - Long Drop

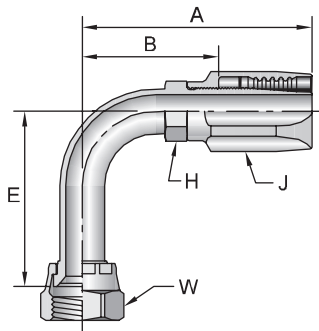

# Part Number	Thread		Hose I.D. inch	A		E		H inch	J inch	W inch	B	
	inch			inch	mm	inch	mm				inch	mm
24120-4-4	1/4	7/16x20	3/16	2.08	53	1.80	46	3/8	5/8	9/16	1.30	33
24120-6-6	3/8	9/16x18	5/16	2.34	59	2.18	55	1/2	13/16	11/16	1.42	36
24120-8-8	1/2	3/4x16	13/32	2.95	75	2.43	62	5/8	15/16	7/8	1.86	47
24120-10-10	5/8	7/8x14	1/2	3.26	83	2.58	66	3/4	1-1/8	1	2.04	52
24120-12-12	3/4	1-1/16x12	5/8	3.78	96	3.74	95	7/8	1-1/4	1-1/4	2.28	58

20420

Male SAE 45° - Rigid

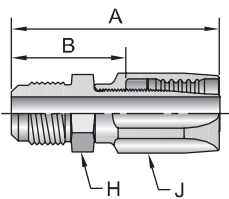

# Part Number	Thread		Hose I.D. inch	A		H inch	J inch	B	
	inch			inch	mm			inch	mm
20420-4-4	1/4	7/16x20	3/16	1.80	46	1/2	5/8	1.02	26
20420-5-5	5/16	1/2x20	1/4	1.94	49	9/16	11/16	1.11	28
20420-6-6	3/8	5/8x18	5/16	2.17	55	11/16	13/16	1.25	32
20420-8-8	1/2	3/4x16	13/32	2.67	68	13/16	15/16	1.58	40
20420-10-10	5/8	7/8x14	1/2	3.00	76	15/16	1-1/8	1.78	45
20420-12-12	3/4	1-1/16x14	5/8	3.50	89	1-1/8	1-1/4	2.00	51

20820

Female SAE 45° - Swivel

# Part Number	Thread		Hose I.D. inch	A		H inch	J inch	W inch	B	
	inch			inch	mm				inch	mm
20820-4-4	1/4	7/16x20	3/16	1.94	49	9/16	5/8	9/16	1.16	29
20820-4-5	1/4	7/16x20	1/4	2.04	52	9/16	11-16	9/16	1.21	31
20820-5-5	5/16	1/2x20	1/4	2.12	54	5/8	11-16	5/8	1.29	33
20820-6-6	3/8	5/8x18	5/16	2.36	60	3/4	13/16	3/4	1.44	37
20820-8-8	1/2	3/4x16	3/8	2.79	71	7/8	15/16	7/8	1.70	43
20820-8-10	1/2	3/4x16	1/2	2.99	76	7/8	1-1/8	7/8	1.77	45
20820-10-10	5/8	7/8x14	1/2	3.10	79	1	1-1/8	1	1.88	48
20820-12-12	3/4	1-1/16x14	5/8	3.49	89	1-1/4	1-1/4	1-1/4	1.99	51

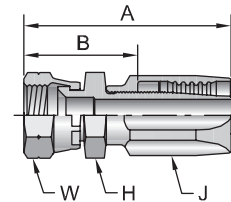

27720

Female SAE 45° - Swivel - 45° Elbow

# Part Number	Thread		Hose I.D. inch	A		E		H inch	J inch	W inch	B	
	inch			inch	mm	inch	mm				inch	mm
27720-6-6	3/8	5/8x18	5/16	2.45	62	0.39	10	1/2	13/16	3/4	1.53	39
27720-8-6	1/2	3/4x16	5/16	2.77	71	0.55	14	5/8	13/16	7/8	1.86	47
27720-8-8	1/2	3/4x16	13/32	3.09	78	0.55	14	5/8	15/16	7/8	2.00	51
27720-10-10	5/8	7/8x14	1/2	3.35	85	0.65	17	3/4	1-1/8	1	2.13	54

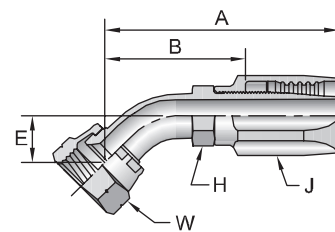

27920

Female SAE 45° - Swivel - 90° Elbow

# Part Number	Thread		Hose I.D. inch	A		E		H inch	J inch	W inch	B	
	inch			inch	mm	inch	mm				inch	mm
27920-4-4	1/4	7/16x20	3/16	1.91	49	0.83	21	3/8	5/8	9/16	1.13	29
27920-5-5	5/16	1/2x20	1/4	2.30	58	0.77	20	7/16	11/16	5/8	1.47	37
27920-6-6	3/8	5/8x18	5/16	2.33	59	0.85	22	1/2	13/16	3/4	1.41	36
27920-8-8	1/2	3/4x16	13/32	2.86	73	1.09	28	5/8	15/16	7/8	1.77	45
27920-10-10	5/8	7/8x14	1/2	3.20	81	1.24	31	3/4	1-1/8	1	1.98	50
27920-12-12	3/4	1-1/16x14	5/8	3.87	98	1.82	46	7/8	1-1/4	1-1/4	2.37	60

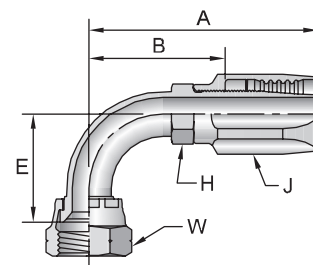

Notch in nut signifies 45° flare.

Hose
A

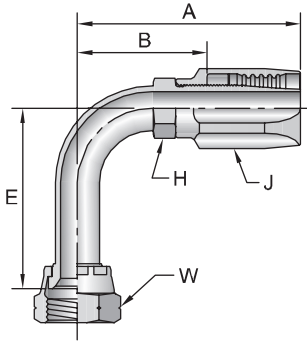

28120

Female SAE 45° - Swivel - 90° Elbow - Long Drop

#	Thread		Hose I.D.	A		E		H	J	W	B	
Part Number	inch		inch	inch	mm	inch	mm	inch	inch	inch	inch	mm
28120-6-6	3/8	5/8x18	5/16	2.34	59	2.18	55	1/2	13/16	3/4	1.42	36
28120-8-8	1/2	3/4x16	13/32	2.95	75	2.43	62	5/8	15/16	7/8	1.86	47

Notch in nut signifies 45° flare.

Fittings 20 Series
B

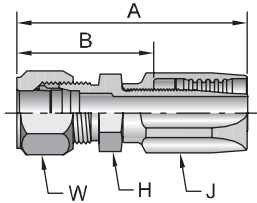

21120

Male Ferulok Flareless - Rigid (24° Cone with Nut and Ferrule)

#	Thread		Hose I.D.	A		H	J	W	B	
Part Number	inch		inch	inch	mm	inch	inch	inch	inch	mm
21120-6-6	3/8	9/16x18	5/16	2.05	52	5/8	13/16	11/16	1.13	29
21120-8-8	1/2	3/4x16	13/32	2.52	64	13/16	15/16	7/8	1.43	36

The Parker Ferrule-Fix fitting makes it possible to salvage the bent tube section from a hose assembly for quick, easy on the job repairs. For additional information see Ferrule-Fix installation instructions in the Technical Section.

Equipment
C

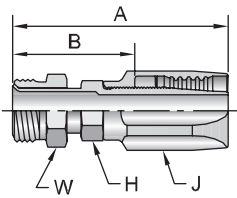

22820

Male Inverted SAE 45° - Swivel

#	Thread		Hose I.D.	A		H	J	W	B	
Part Number	inch		inch	inch	mm	inch	inch	inch	inch	mm
22820-4-4	1/4	7/16x24	3/16	2.45	62	3/8	5/8	7/16	1.67	42
22820-5-5	5/16	1/2x20	1/4	2.70	69	7/16	11/16	1/2	1.87	47
22820-6-6	3/8	5/8x18	5/16	2.95	75	1/2	13/16	5/8	2.03	52
22820-8-8	1/2	3/4x18	13/32	3.36	85	5/8	15/16	3/4	2.27	58
22820-10-10	5/8	7/8x18	1/2	3.64	92	3/4	1-1/8	7/8	2.42	61

Accessories
D

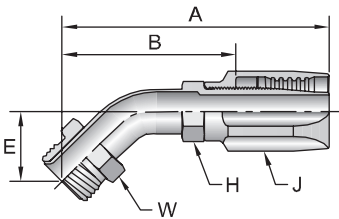

26720

Male Inverted SAE 45° - Swivel - 45° Elbow

#	Thread		Hose I.D.	A		E		H	J	W	B	
Part Number	inch		inch	inch	mm	inch	mm	inch	inch	inch	inch	mm
26720-4-4	1/4	7/16x24	3/16	2.21	56	0.62	16	3/8	5/8	7/16	1.43	36
26720-5-5	5/16	1/2x20	1/4	2.44	62	0.70	18	7/16	11/16	1/2	1.61	41
26720-6-6	3/8	5/8x18	5/16	3.00	76	0.94	24	1/2	13/16	5/8	2.08	53
26720-8-8	1/2	3/4x18	13/32	3.51	89	1.09	28	5/8	15/16	3/4	2.42	61

Technical
E

26920

Male Inverted SAE 45° - Swivel - 90° Elbow

# Part Number	Thread		Hose I.D. inch	A		E		H inch	J inch	W inch	B	
	inch	7/16x24		inch	inch	mm	inch				mm	inch
26920-4-4	1/4	7/16x24	3/16	2.29	58	1.56	40	3/8	5/8	7/16	1.51	38
26920-5-5	5/16	1/2x20	1/4	2.55	65	1.65	42	7/16	11/16	1/2	1.72	44
26920-5-6	5/16	1/2x20	5/16	2.63	67	1.65	42	1/2	13/16	1/2	1.71	43
26920-6-6	3/8	5/8x18	5/16	2.67	68	1.69	43	1/2	13/16	5/8	1.75	44
26920-8-8	1/2	3/4x18	13/32	3.09	78	1.88	48	5/8	15/16	3/4	2.00	51

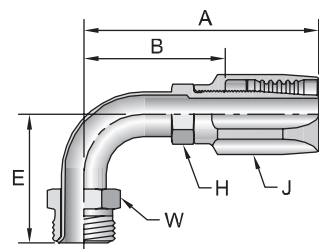

23220

Female PTT 30° - Swivel

# Part Number	Thread inch	Hose I.D. inch	A		H inch	J inch	W inch	B		
			inch	mm				inch	mm	
23220-16-16	1	1-5/16x14	7/8	2.98	76	1-1/2	1-7/16	1-1/2	1.79	45

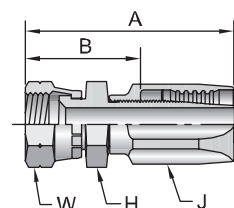

26120

Male SAE Compression Seat (without Nut or Sleeve)

# Part Number	Thread		Hose I.D. inch	A		H inch	J inch	B	
	inch	13/16x18		inch	mm			inch	mm
26120-10-10	5/8	13/16x18	1/2	2.64	67	7/8	1-1/8	1.42	36

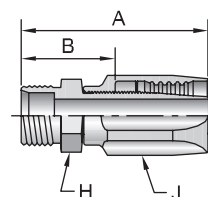

21520

SAE Code 61 Flange Head ISO 12151-3-S-L

# Part Number	Flange inch	Hose I.D. inch	A		F inch	H inch	J inch	B	
			inch	mm				inch	mm
21520-20-20	1-1/4	1-1/8	3.58	91	2	1-1/2	1-3/4	2.30	58
21520-40-40	2-1/2	2-3/8	5.22	133	3-5/16	2-3/4	3-1/8	3.41	87

See Accessories Section for O-Rings and Flange Kits.

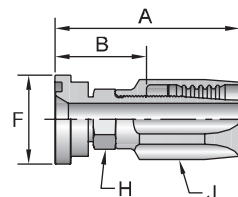

Hose
A

Fittings 20 Series
B

Equipment
C

Accessories
D

Technical
E

Hose
A

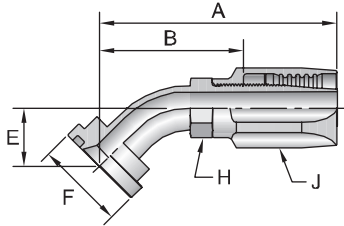

21720

SAE Code 61 Flange Head - 45° Elbow

ISO 12151-3- E45S - L (1 Piece: ISO 12151-3- E45M - L)

#			A		E					B	
Part Number	Flange inch	Hose I.D. inch	inch	mm	inch	mm	inch	inch	inch	inch	mm
21720-20-20	1-1/4	1-1/8	4.10	104	1.12	28	2	1-1/2	1-3/4	2.82	72
21720-40-40	2-1/2	2-3/8	5.83	148	1.41	36	3-3/8	2-3/4	3-1/8	4.02	102

Fittings 20 Series
B

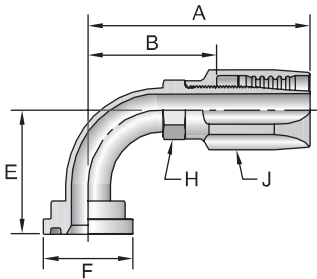

21920

SAE Code 61 Flange Head - 90° Elbow

ISO 12151-3- E90S - L (1 Piece: ISO 12151-3- E90M - L)

#			A		E					B	
Part Number	Flange inch	Hose I.D. inch	inch	mm	inch	mm	inch	inch	inch	inch	mm
21920-8-8	1/2	13/32	2.95	75	1.62	41	1-3/16	5/8	15/16	1.86	47
21920-32-32	2	1-13/16	5.44	138	3.19	81	2-13/16	2-1/4	2-1/2	3.70	94
21920-40-40	2-1/2	2-3/8	6.18	157	3.75	95	3-5/16	2-3/4	3-1/8	4.37	111

Equipment
C

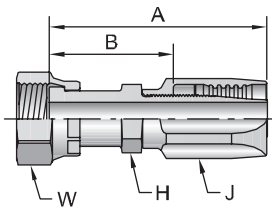

2JS20

Female Seal-Lok® - Swivel - Long

ISO 12151-1 - SWSB

#			A					B		
Part Number	Thread inch	Hose I.D. inch	inch	mm	inch	inch	inch	inch	mm	
2JS20-4-4	1/4	9/16x18	3/16	2.07	53	9/16	5/8	11/16	1.29	33
2JS20-6-6	3/8	11/16x16	5/16	2.36	60	1/2	13/16	13/16	1.44	37
2JS20-8-8	1/2	13/16x16	13/32	2.92	74	5/8	15/16	15/16	1.83	46
2JS20-10-10	5/8	1x14	1/2	3.15	80	3/4	1-1/8	1-1/8	1.93	49
2JS20-12-12	3/4	1-3/16x12	5/8	3.66	93	1-1/8	1-1/4	1-3/8	2.16	55

Accessories
D

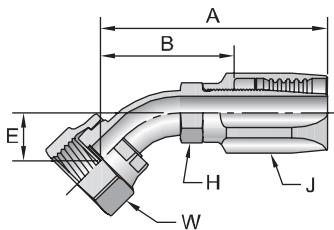

2J720

Female Seal-Lok® - Swivel - 45° Elbow

ISO 12151-1 - SWE45

#			A		E					B		
Part Number	Thread inch	Hose I.D. inch	inch	mm	inch	mm	inch	inch	inch	inch	mm	
2J720-4-4	1/4	9/16x18	3/16	2.24	57	0.41	10	7/16	5/8	11/16	1.46	37
2J720-6-6	3/8	11/16x16	5/16	2.52	64	0.43	11	1/2	13/16	13/16	1.60	41
2J720-8-8	1/2	13/16x16	13/32	3.19	81	0.59	15	5/8	15/16	15/16	2.10	53
2J720-10-10	5/8	1x14	1/2	3.46	88	0.65	17	3/4	1-1/8	1-1/8	2.24	57

Technical
E

See Accessories Section for O-Rings and Flange Kits.

2J920

Female Seal-Lok® - Swivel 90° Elbow - Short Drop

ISO 12151-1 - SWE90

# Part Number	Thread		Hose I.D. inch	A		E		H inch	J inch	W inch	B	
	inch	inch		inch	mm	inch	mm				inch	mm
2J920-4-4	1/4	9/16x18	3/16	2.22	56	0.82	21	7/16	5/8	11/16	1.44	37
2J920-6-6	3/8	11/16x16	5/16	2.39	61	0.90	23	1/2	13/16	13/16	1.47	37
2J920-8-8	1/2	13/16x16	13/32	2.91	74	1.15	29	5/8	15/16	15/16	1.82	46
2J920-10-10	5/8	1x14	1/2	3.16	80	1.27	32	3/4	1-1/8	1-1/8	1.94	49
2J920-12-12	3/4	1-3/16x12	5/8	3.74	95	1.85	47	7/8	1-1/4	1-3/8	2.24	57

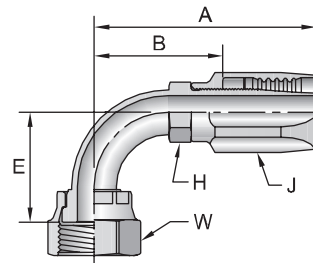

2J120

Female Seal-Lok® - Swivel - 90° Elbow - Long Drop

ISO 12151-1 - SWEL90

# Part Number	Thread		Hose I.D. inch	A		E		H inch	J inch	W inch	B	
	inch	inch		inch	mm	inch	mm				inch	mm
2J120-4-4	1/4	9/16x18	3/16	2.01	51	1.80	46	7/16	5/8	11/16	1.23	31
2J120-6-6	3/8	11/16x16	5/16	2.48	63	2.13	54	1/2	13/16	13/16	1.56	40
2J120-8-8	1/2	13/16x16	13/32	2.96	75	2.51	64	5/8	15/16	15/16	1.87	47

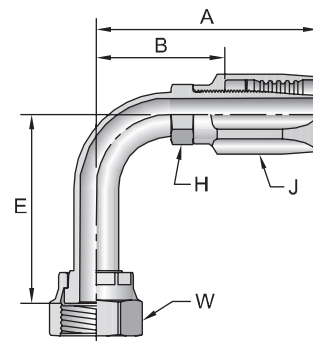

See Accessories Section for O-Rings.

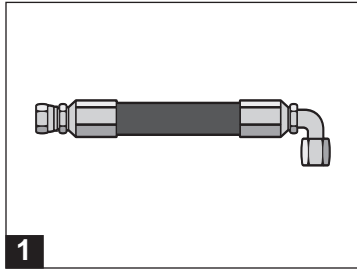

20 Series Hose Assembly Instructions

1. Identify over all length (OAL) of hose assembly and the cut off allowance (COA) length of fitting(s) on hose ends by use of the fitting data table. Properly measure, mark and cut hose to desired length using fine tooth hacksaw or cutoff machine. Care should be taken to ensure a square, clean cut is obtained.

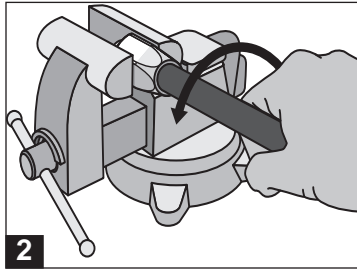

2. Air or solvent flush cut end of hose as necessary to produce a clean hose ID prior to assembly. Place socket in vice and screw in hose counter clockwise until hose bottoms. Back hose out 1/2 turn.

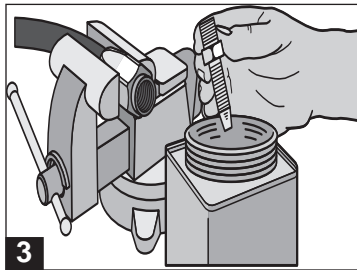

3. Oil inside of hose and nipple threads liberally with Hoze-Oil. (See Section C). Do not oil hose cover.

4. Screw nipple assembly into socket using a wrench on the nipple hex until the nipple hex shoulders against the socket. A 1/32" to 1/16" gap between the nipple hex and socket is allowed for displacement angle adjustment when two elbow fittings are used.

Inspection. Examine hose assembly internally for cut or bulged tube, obstructions and cleanliness. Clean ID of hose as necessary. Swivel nuts should turn freely. Check the layline of the hose to be sure the assembly is not twisted. Cap the ends of the assembly to keep clean.

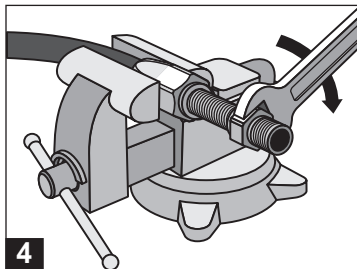

Special Instructions for stainless steel fittings. When assembling fittings made with 316 stainless steel, lubricate the threads of both the socket and nipple with Accrolube High Efficiency Lubricant (see Section C) or equivalent metal assembly lubricant.











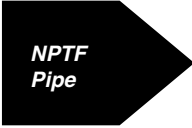



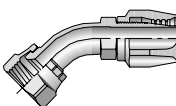
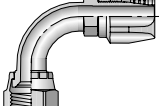
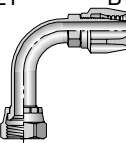

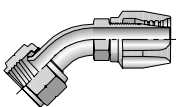
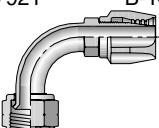
Note: DISASSEMBLE IN REVERSE ORDER

IF YOU HAVE QUESTIONS CONCERNING THE PRODUCTS OR APPLICATION OF THE PRODUCTS CONTAINED IN THIS CATALOG, PLEASE CALL: PARKER HOSE PRODUCTS DIVISION - TECHNICAL SERVICES DEPARTMENT

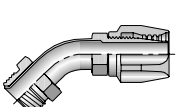
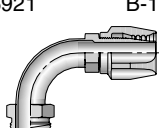
PHONE: 440/943-5700

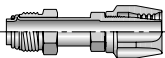
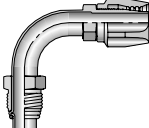
FAX: 440/943-3129

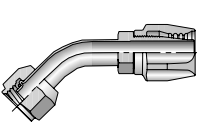
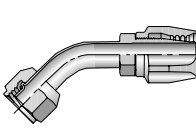
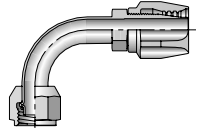
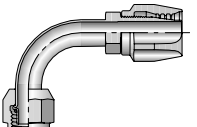
<http://www.parkerhose.com>

 NPTF Pipe	20121 B-138  <i>Male - Rigid</i>	 JIC 37°	20621 B-138  <i>Female - Swivel</i>	23721 B-138  <i>Female - Swivel 45° Elbow - Short</i>	23921 B-139  <i>Female - Swivel 90° Elbow - Short</i>
24121 B-139  <i>Female - Swivel 90° Elbow - Long</i>	 SAE 45°	20821 B-139  <i>Female - Swivel</i>	27721 B-139  <i>Female - Swivel 45° Elbow</i>	27921 B-140  <i>Female - Swivel 90° Elbow</i>	 PTT 30°
23221 B-140  <i>Female - Swivel</i>	 Inverted Flare	22821 B-140  <i>Male - Swivel</i>	26721 B-140  <i>Male - Swivel 45° Elbow</i>	26921 B-141  <i>Male - Swivel 90° Elbow</i>	 Tube-O
2S521 B-141  <i>Male - Swivel Short</i>	25M21 B-141  <i>Male - Swivel 90° Elbow - Long</i>	25S21 B-141  <i>Female - Swivel Short</i>	25H21 B-142  <i>Female - Swivel 45° Elbow - Short</i>	25N21 B-142  <i>Female - Swivel 45° Elbow - Long</i>	25T21 B-142  <i>Female - Swivel 90° Elbow - Short</i>
25L21 B-142  <i>Female - Swivel 90° Elbow - Long</i>	 Assembly Instructions	21 Series B-143 Assembly Instructions			

Hose
A

Fittings 21 Series
B

Equipment
C

Accessories
D

Technical
E

Hose
A

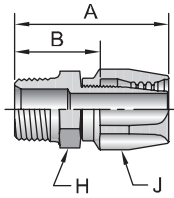

20121 Male NPTF Pipe - Rigid

# Part Number	Thread		Hose I.D. inch	A		H inch	J inch	B	
	inch	inch		inch	mm			inch	mm
20121-2-4	1/8x27	3/16	3/16	1.55	39	7/16	9/16	0.88	22
20121-4-4	1/4x18	3/16	3/16	1.77	45	9/16	9/16	1.10	28
20121-4-5	1/4x18	1/4	1/4	1.79	45	9/16	5/8	1.05	27
20121-4-6	1/4x18	5/16	5/16	1.92	49	9/16	3/4	1.14	29
20121-6-6	3/8x18	5/16	5/16	1.95	50	11/16	3/4	1.17	30
20121-6-8	3/8x18	13/32	13/32	2.10	53	11/16	7/8	1.18	30
20121-8-8	1/2x14	13/32	13/32	2.34	59	7/8	7/8	1.42	36
20121-8-10	1/2x14	1/2	1/2	2.44	62	7/8	1-1/16	1.44	37
20121-12-12	3/4x14	5/8	5/8	2.58	66	1-1/8	1-1/4	1.50	38
20121-12-16	3/4x14	7/8	7/8	2.50	64	1-1/4	1-7/16	1.51	38
20121-16-16	1x11-1/2	7/8	7/8	2.69	68	1-3/8	1-7/16	1.70	43
20121-20-20	1-1/4x11-1/2	1-1/8	1-1/8	2.91	74	1-11/16	1-3/4	1.87	47
20121-24-24	1-1/2x11-1/2	1-3/8	1-3/8	3.02	77	2	2	1.92	49

Fittings 21 Series
B

20621 Female JIC 37° - Swivel

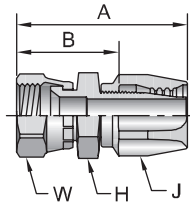

# Part Number	Thread		Hose I.D. inch	A		H inch	J inch	W inch	B	
	inch	inch		inch	mm				inch	mm
20621-4-4	1/4	7/16x20	3/16	1.83	46	9/16	9/16	9/16	1.16	29
20621-5-5	5/16	1/2x20	1/4	1.92	49	5/8	5/8	5/8	1.18	30
20621-6-6	3/8	9/16x18	5/16	2.09	53	11/16	3/4	11/16	1.31	33
20621-8-8	1/2	3/4x16	13/32	2.46	62	7/8	7/8	7/8	1.54	39
20621-8-10	1/2	3/4x16	1/2	2.56	65	1	1-1/16	7/8	1.56	40
20621-10-10	5/8	7/8x14	1/2	2.65	67	1	1-1/16	1	1.65	42
20621-12-12	3/4	1-1/16x12	5/8	2.85	72	1-1/4	1-1/4	1-1/4	1.77	45
20621-16-16	1	1-5/16x12	7/8	2.94	75	1-1/2	1-7/16	1-1/2	1.95	50
20621-20-20	1-1/4	1-5/8x12	1-1/8	3.16	80	2	1-3/4	2	2.12	54

Equipment
C

23721 Female JIC 37° - Swivel - 45° Elbow - Short Drop

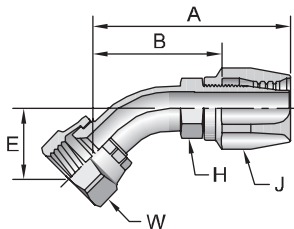

# Part Number	Thread		Hose I.D. inch	A		E		H inch	J inch	W inch	B	
	inch	inch		inch	mm	inch	mm				inch	mm
23721-4-4	1/4	7/16x20	3/16	2.11	54	0.39	10	3/8	9/16	9/16	1.43	36
23721-6-6	3/8	9/16x18	5/16	2.26	57	0.40	10	1/2	3/4	11/16	1.48	38
23721-8-8	1/2	3/4x16	13/32	2.73	69	0.55	14	5/8	7/8	7/8	1.81	46
23721-10-10	5/8	7/8x14	1/2	2.97	75	0.64	16	3/4	1-1/16	1	1.97	50
23721-12-12	3/4	1-1/16x12	5/8	3.30	84	0.83	21	7/8	1-1/4	1-1/4	2.22	56
23721-16-16	1	1-5/16x12	7/8	3.44	87	0.90	23	1-1/8	1-7/16	1-1/2	2.45	62
23721-20-20	1-1/4	1-5/8x12	1-1/8	3.80	97	1.19	30	1-3/8	1-3/4	2	2.76	70

Accessories
D

Technical
E

23921

Female JIC 37° - Swivel - 90° Elbow - Short Drop

# Part Number	Thread		Hose I.D. inch	A		E		H inch	J inch	W inch	B	
	inch	inch		inch	mm	inch	mm				inch	mm
23921-4-4	1/4	7/16 x 20	3/16	1.88	48	0.83	21	3/8	9/16	9/16	1.20	30
23921-4-6	1/4	7/16 x 20	5/16	1.95	50	0.83	21	1/2	3/4	9/16	1.17	30
23921-5-5	5/16	1/2 x 20	1/4	2.07	53	0.77	20	7/16	5/8	5/8	1.33	34
23921-6-6	3/8	9/16x18	5/16	2.15	55	0.85	22	1/2	3/4	11/16	1.37	35
23921-8-8	1/2	3/4 x 16	13/32	2.49	63	1.09	28	5/8	7/8	7/8	1.57	40
23921-10-10	5/8	7/8 x 14	1/2	2.69	68	1.23	31	3/4	1-1/16	1	1.69	43
23921-12-12	3/4	1-1/16 x 12	5/8	2.88	73	1.89	48	7/8	1-1/4	1-1/4	1.80	46
23921-16-16	1	1-5/16 x 12	7/8	3.40	86	2.14	54	1-1/8	1-7/16	1-1/2	2.41	61
23921-20-20	1-1/4	1-5/8 x 12	1-1/8	3.64	92	2.59	66	1-3/8	1-3/4	2	2.60	66

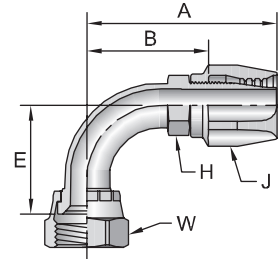

24121

Female JIC 37° - Swivel - 90° Elbow - Long Drop

# Part Number	Thread		Hose I.D. inch	A		E		H inch	J inch	W inch	B	
	inch	inch		inch	mm	inch	mm				inch	mm
24121-4-4	1/4	7/16x20	3/16	1.88	48	2.52	64	3/8	9/16	9/16	1.20	30
24121-6-6	3/8	9/16x18	5/16	2.14	54	2.18	55	1/2	3/4	11/16	1.36	35
24121-8-8	1/2	3/4x16	13/32	2.45	62	2.52	64	5/8	7/8	7/8	1.53	39
24121-10-10	5/8	7/8x14	1/2	2.91	74	2.57	65	3/4	1-1/16	1	1.91	49
24121-20-20	1-1/4	1-5/8x12	1-1/8	3.63	92	5.28	134	1-3/8	1-3/4	2	2.59	66

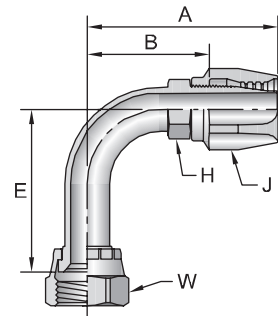

20821

Female SAE 45° - Swivel

# Part Number	Thread		Hose I.D. inch	A		H inch	J inch	W inch	B	
	inch	inch		inch	mm				inch	mm
20821-4-4	1/4	7/16x20	3/16	1.83	46	9/16	9/16	9/16	1.16	29
20821-5-5	5/16	1/2x20	1/4	1.91	49	5/8	5/8	5/8	1.17	30
20821-6-6	3/8	5/8x18	5/16	2.12	54	3/4	3/4	3/4	1.34	34
20821-8-8	1/2	3/4x16	13/32	2.46	62	7/8	7/8	7/8	1.54	39
20821-10-10	5/8	7/8x14	1/2	2.65	67	1	1-1/16	1	1.65	42
20821-12-12	3/4	1-1/16x14	5/8	2.85	72	1-1/4	1-1/4	1-1/4	1.77	45

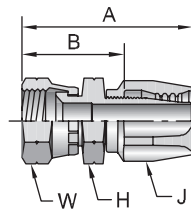

27721

Female SAE 45° - Swivel - 45° Elbow

# Part Number	Thread		Hose I.D. inch	A		E		H inch	J inch	W inch	B	
	inch	inch		inch	mm	inch	mm				inch	mm
27721-6-6	3/8	5/8x18	5/16	2.26	57	0.40	10	1/2	3/4	3/4	1.48	38
27721-12-12	3/4	1-1/16x14	5/8	3.30	84	0.83	21	7/8	1-1/4	1-1/4	2.22	56

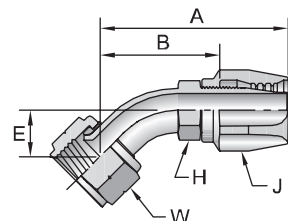

Notch in nut signifies 45° flare.

Hose
A

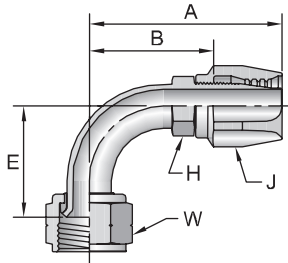

27921
Female SAE 45° - Swivel - 90° Elbow

# Part Number	Thread		Hose I.D. inch	A		E		H inch	J inch	W inch	B	
	inch	inch		inch	mm	inch	mm				inch	mm
27921-6-6	3/8	5/8x18	5/16	2.15	55	0.85	22	1/2	3/4	3/4	1.37	35
27921-12-12	3/4	1-1/16x14	5/8	2.88	73	1.89	48	7/8	1-1/4	1-1/4	1.89	46

Notch in nut signifies 45° flare.

Fittings 21 Series
B

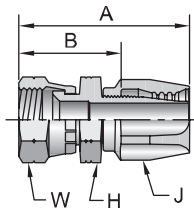

23221
Female PTT 30° - Swivel

# Part Number	Thread inch	Hose I.D. inch	A		H inch	J inch	W inch	B		
			inch	mm				inch	mm	
23221-16-16	1	1-5/16x14	7/8	2.70	69	1-1/2	1-7/16	1-1/2	1.71	43

Equipment
C

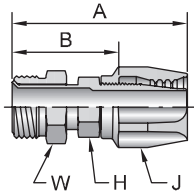

22821
Male Inverted SAE 45° - Swivel

# Part Number	Thread		Hose I.D. inch	A		H inch	J inch	W inch	B	
	inch	inch		inch	mm				inch	mm
22821-4-4	1/4	7/16x24	3/16	2.36	60	3/8	9/16	7/16	1.68	43
22821-5-4	5/16	1/2x20	3/16	2.32	59	7/16	9/16	1/2	1.64	42
22821-5-5	5/16	1/2x20	1/4	2.34	59	7/16	5/8	1/2	1.60	41
22821-5-6	5/16	1/2x20	5/16	2.47	63	1/2	3/4	1/2	1.69	43
22821-6-6	3/8	5/8x18	5/16	2.45	62	1/2	3/4	5/8	1.67	42
22821-8-8	1/2	3/4x18	13/32	2.84	72	5/8	7/8	3/4	1.92	49
22821-10-10	5/8	7/8x18	1/2	2.91	74	3/4	1-1/16	7/8	1.91	49

Accessories
D

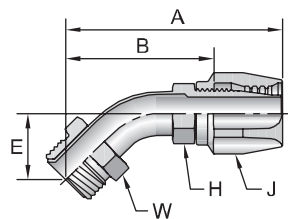

26721
Male Inverted SAE 45° - Swivel - 45° Elbow

# Part Number	Thread		Hose I.D. inch	A		E		H inch	J inch	W inch	B	
	inch	inch		inch	mm	inch	mm				inch	mm
26721-4-4	1/4	7/16x24	3/16	2.35	60	0.62	16	3/8	9/16	7/16	1.67	42
26721-5-5	5/16	1/2x20	1/4	2.59	66	0.94	24	7/16	5/8	1/2	1.85	47
26721-6-6	3/8	5/8x18	5/16	2.73	69	0.94	24	1/2	3/4	5/8	1.95	50
26721-8-8	1/2	3/4x18	13/32	3.05	77	0.94	24	5/8	7/8	3/4	2.13	54

Technical
E

26921

Male Inverted SAE 45° - Swivel - 90° Elbow

# Part Number	Thread inch	Hose I.D. inch	A		E		H inch	J inch	W inch	B		
			inch	mm	inch	mm				inch	mm	
26921-4-4	1/4	7/16x24	3/16	2.45	62	1.56	40	3/8	9/16	7/16	1.77	45
26921-5-5	5/16	1/2x20	1/4	2.25	57	1.65	42	7/16	5/8	1/2	1.51	38
26921-5-6	5/16	1/2x20	5/16	2.38	60	1.65	42	1/2	3/4	1/2	1.60	41
26921-6-6	3/8	5/8x18	5/16	2.37	60	1.63	41	1/2	3/4	5/8	1.59	40
26921-8-8	1/2	3/4x18	13/32	2.63	67	1.78	45	5/8	7/8	3/4	1.71	43
26921-10-10	5/8	7/8x18	1/2	2.96	75	2.17	55	3/4	1-1/16	7/8	1.96	50

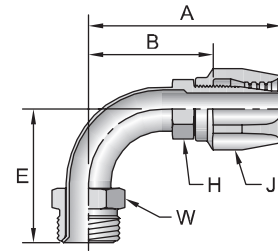

2S521

Male Tube-O - Swivel - Short Pilot

# Part Number	Thread inch	Hose I.D. inch	A		D		H inch	J inch	W inch	B		
			inch	mm	inch	mm				inch	mm	
2S521-6-6	3/8	5/8x18	5/16	2.64	67	0.18	4,7	1/2	3/4	5/8	1.86	47

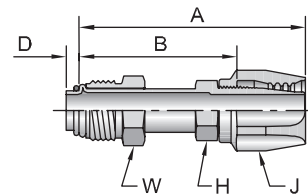

25M21

Male Tube-O - Swivel - 90° Elbow - Long Pilot

# Part Number	Thread inch	Hose I.D. inch	A		D		E		H inch	J inch	W inch	B		
			inch	mm	inch	mm	inch	mm				inch	mm	
25M21-8-8	1/2	3/4x18	13/32	2.49	63	0.38	9,8	2.12	54	5/8	7/8	3/4	1.57	40
25M21-10-10	5/8	7/8x18	1/2	3.27	83	0.38	9,8	1.95	50	3/4	1-1/16	7/8	2.27	58

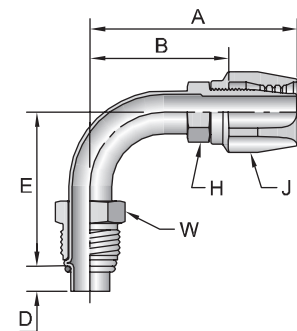

25S21

Female Tube-O - Swivel - Short Pilot

# Part Number	Thread inch	Hose I.D. inch	A		D		H inch	J inch	W inch	B		
			inch	mm	inch	mm				inch	mm	
25S21-6-6	3/8	5/8x18	5/16	2.66	68	0.18	4,7	1/2	3/4	3/4	1.88	48
25S21-8-8	1/2	3/4x16	13/32	2.86	73	0.18	4,7	5/8	7/8	7/8	1.94	49

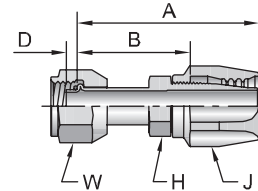

Hose
A

Fittings 21 Series
B

Equipment
C

Accessories
D

Technical
E

Hose
A

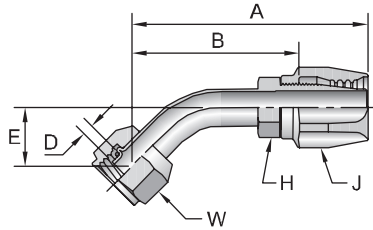

25H21

Female Tube-O - Swivel - 45° Elbow - Short Pilot

#	Thread	Hose I.D.	A		D		E		H	J	W	B	
Part Number	inch	inch	inch	mm	inch	mm	inch	mm	inch	inch	inch	inch	mm
25H21-8-8	1/2 3/4x16	13/32	2.74	70	0.18	4,7	0.60	15	5/8	7/8	7/8	1.82	46

Fittings 21 Series
B

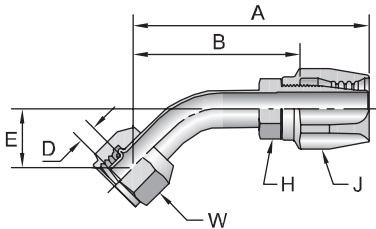

25N21

Female Tube-O - Swivel - 45° Elbow - Long Pilot

#	Thread	Hose I.D.	A		D		E		H	J	W	B	
Part Number	inch	inch	inch	mm	inch	mm	inch	mm	inch	inch	inch	inch	mm
25N21-8-8	1/2 3/4x16	13/32	3.24	82	0.38	9,8	0.98	25	5/8	7/8	7/8	2.32	59

Equipment
C

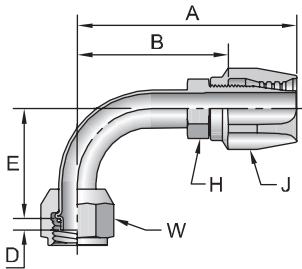

25T21

Female Tube-O - Swivel - 90° Elbow - Short Pilot

#	Thread	Hose I.D.	A		D		E		H	J	W	B	
Part Number	inch	inch	inch	mm	inch	mm	inch	mm	inch	inch	inch	inch	mm
25T21-6-6	3/8 5/8x18	5/16	2.35	60	0.18	4,7	1.21	31	1/2	3/4	3/4	1.57	40
25T21-8-8	1/2 3/4x16	13/32	2.83	72	0.18	4,7	1.31	33	5/8	7/8	7/8	1.91	49
25T21-10-10	5/8 7/8x14	1/2	3.33	85	0.18	4,7	1.50	38	3/4	1-1/16	1-1/16	2.33	59

Accessories
D

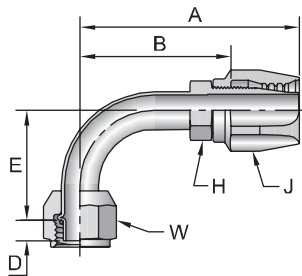

25L21

Female Tube-O - Swivel - 90° Elbow - Long Pilot

#	Thread	Hose I.D.	A		D		E		H	J	W	B	
Part Number	inch	inch	inch	mm	inch	mm	inch	mm	inch	inch	inch	inch	mm
25L21-6-6	3/8 5/8x18	5/16	2.28	58	0.28	7,1	1.43	36	1/2	3/4	3/4	1.50	38
25L21-8-8	1/2 3/4x16	13/32	2.50	64	0.38	9,8	1.46	37	5/8	7/8	7/8	1.58	40
25L21-10-10	5/8 7/8x14	1/2	2.83	72	0.38	9,8	1.75	44	3/4	1-1/16	1-1/16	1.83	46

Technical
E

21 Series Hose Assembly Instructions

1. Identify over all length (OAL) of hose assembly and the cut off allowance (COA) length of fitting(s) on hose ends by use of the fitting data table. Properly measure, mark and cut hose to desired length using fine tooth hacksaw or a cutoff machine. Care should be taken to ensure a square, clean cut is obtained.
2. Air or solvent flush cut end of hose as necessary to produce a clean hose ID prior to assembly. Place socket in vice and screw in hose counter clockwise until hose bottoms. Back hose out 1/2 turn.
3. Oil inside of hose and nipple threads liberally with Hoze-Oil. (See Section C). Do not oil hose cover.
4. Screw nipple assembly into socket using a wrench on the nipple hex until the nipple hex shoulders against the socket. A 1/32" to 1/16" gap between the nipple hex and socket is allowed for displacement angle adjustment when elbow fittings are used.

Inspection. Examine hose assembly internally for cut or bulged tube, obstructions and cleanliness. Clean ID of hose as necessary. Swivel nuts should turn freely. Check the layline of the hose to be sure the assembly is not twisted. Cap the ends of the assembly to keep clean.

Special instructions for stainless steel fittings. When assembling fittings made with 316 stainless steel, lubricate the threads of both the socket and nipple with Accrolube High Efficiency Lubricant (see Section C) or equivalent metal assembly lubricant.

Note: Disassemble in reverse order.

IF YOU HAVE QUESTIONS CONCERNING THE PRODUCTS
OR APPLICATION OF THE PRODUCTS CONTAINED IN THIS
CATALOG, PLEASE CALL: PARKER HOSE PRODUCTS
DIVISION - TECHNICAL SERVICES DEPARTMENT
PHONE: 440 / 943-5700
FAX: 440 / 943-3129
<http://www.parkerhose.com>

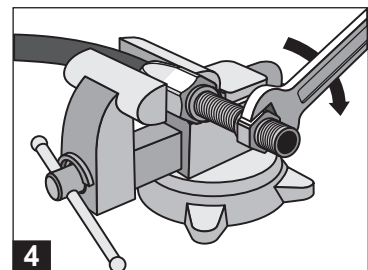
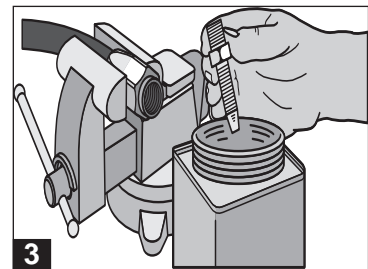
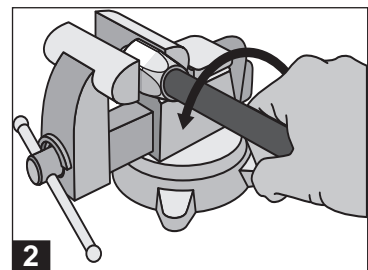
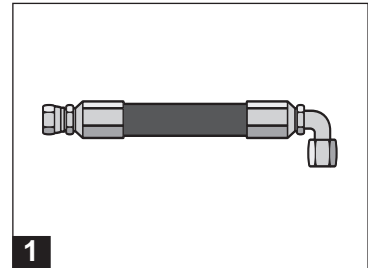

Hose
A

Fittings 21 Series
B

Equipment
C

Accessories
D

Technical
E







Hose
A

Fittings 21 Series
B

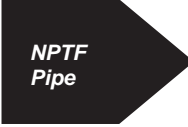
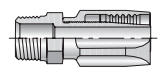
Equipment
C

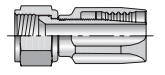
Accessories
D

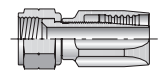
Technical
E

 <p>NPTF Pipe</p>	<p>20122 B-146</p>  <p><i>Male - Rigid</i></p>	 <p>JIC 37°</p>	<p>20622 B-146</p>  <p><i>Female - Swivel</i></p>	 <p>SAE 45°</p>	<p>20822 B-146</p>  <p><i>Female - Swivel</i></p>
 <p>Assembly Instructions</p>	<p>22 Series B-147 Assembly Instructions</p>				

Hose
A

Fittings 22 Series
B

Equipment
C

Accessories
D

Technical
E

Hose
A

Fittings 22 Series
B

Equipment
C

Accessories
D

Technical
E

20122 Male NPTF Pipe - Rigid

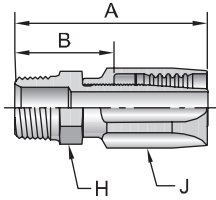

# Part Number	Thread		Hose I.D.		A		B		Additional Material Brass (B)
	inch	inch	inch	mm	inch	inch	inch	mm	
20122-2-4	1/8x27	3/16	1.72	44	7/16	5/8	0.94	24	
20122-4-4	1/4x18	3/16	1.92	49	9/16	5/8	1.92	29	•
20122-4-5	1/4x18	1/4	2.01	51	9/16	11/16	1.18	30	•
20122-4-6	1/4x18	5/16	2.11	54	9/16	13/16	1.19	30	•
20122-6-8	3/8x18	13/32	2.49	63	3/4	15/16	1.40	36	•
20122-12-12	3/4x14	5/8	3.25	83	1-1/16	1-1/4	1.75	44	•

20622 Female JIC 37° - Swivel

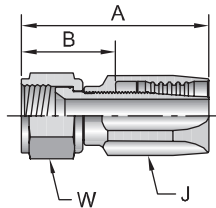

# Part Number	Thread		Hose I.D.		A		B		Additional Material Brass (B)	
	inch	inch	inch	mm	inch	inch	inch	mm		
20622-4-4~	1/4	7/16x20	3/16	1.74	44	5/8	9/16	0.96	24	•
20622-5-5~	5/16	1/2x20	1/4	1.91	49	11/16	5/8	1.08	27	•
20622-6-6	3/8	9/16x18	5/16	2.05	52	13/16	11/16	1.13	29	•
20622-8-8~	1/2	3/4x16	13/32	2.55	65	15/16	7/8	1.46	37	•
20622-10-10~	5/8	7/8x14	1/2	2.80	71	1-1/8	1	1.58	40	•
20622-12-12	3/4	1-1/16x12	5/8	3.15	80	1-1/4	1-1/8	1.65	42	•
20622-16-16	1	1-5/16x12	7/8	2.84	72	1-7/16	1-1/2	1.65	42	•
20622-20-20	1-1/4	1-5/8x12	1-1/8	3.00	76	1-3/4	2	1.72	44	•
20622-24-24	1-1/2	1-7/8x12	1-3/8	3.30	84	2	2-1/4	1.93	49	•
20622-32-32	2	2-1/2x12	1-13/16	4.05	103	2-1/2	2-7/8	2.31	59	•
20622-40-40	2-1/2	3x12	2-3/8	4.17	106	3-1/8	3-3/8	2.36	60	•

~These 20622 fittings contain a dual seat that accepts both the JIC (37°) and SAE (45°) male configurations. The -6 and -12 SAE (45°) swivel fittings are shown under part number 20822.

20822 Female SAE 45° - Swivel

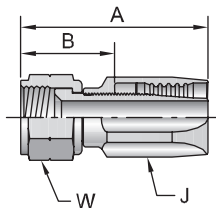

# Part Number	Thread		Hose I.D.		A		B		Additional Material Brass (B)	
	inch	inch	inch	mm	inch	inch	inch	mm		
20822-4-4	1/4	7/16x20	3/16	1.74	44	5/8	9/16	0.96	24	•
20822-5-5	5/16	1/2x20	1/4	1.91	49	11/16	5/8	1.08	27	•
20822-6-6	3/8	5/8x18	5/16	2.08	53	13/16	3/4	1.16	29	•
20822-8-8	1/2	3/4x16	13/32	2.45	62	15/16	7/8	1.36	35	•
20822-10-10	5/8	7/8x14	1/2	2.80	71	1-1/8	1	1.58	40	•
20822-12-12	3/4	1-1/16x14	5/8	3.10	79	1-1/4	1-1/4	1.60	41	•

Notch in nut for SAE (45°) flare.

22 Series Mandrel Assembly Instructions

1. Identify over all length (OAL) of hose assembly and the cut off allowance (COA) length of fitting(s) on hose ends by use of the fitting data table. Properly measure, mark and cut hose to desired length using fine tooth hacksaw or a cutoff machine. Care should be taken to ensure a square, clean cut is obtained. Air or solvent flush cut end of hose as necessary to produce a clean hose ID prior to assembly. Place socket in vice and screw in hose counter clockwise until hose bottoms. Back hose out $\frac{1}{2}$ turn.
2. When assembling male pipe ends, slide nipple onto mandrel.
3. When assembling swivel ends, slide swivel nut over nipple. Slide nut and nipple onto mandrel. Screw mandrel threads into nipple and wrench tighten.
4. Oil inside of hose and nipple threads liberally with Hoze-Oil. (See Section C). **Do not oil hose cover.**
5. Push nipple into socket.
 - Male ends: Thread nipple in until it bottoms against socket.
 - Swivel ends: Thread nipple into socket using hex on assembly mandrel. Leave clearance of approximately $\frac{1}{32}$ " (.784mm) between nut and socket to allow nut to swivel. **Remove mandrel.**

Note: Disassemble in reverse order.

Caution: Do Not Attempt to Assemble These Fittings to the Hose Without Using a Mandrel.

Inspection. Examine hose assembly internally for cut or bulged tube, obstructions and cleanliness. Clean ID of hose as necessary. Swivel nuts should turn freely. Check the layline of the hose to be sure the assembly is not twisted. Cap the ends of the assembly to keep clean.

Special Instructions for Refrigerant Hose. Oil inside of hose and nipple threads liberally with the same oil used in refrigeration system. **Do not oil hose cover.** Do not allow hose to contact any petroleum base fluids.

IF YOU HAVE QUESTIONS CONCERNING THE PRODUCTS OR APPLICATION OF THE PRODUCTS CONTAINED IN THIS CATALOG, PLEASE CALL: PARKER HOSE PRODUCTS DIVISION TECHNICAL SERVICES DEPARTMENT
PHONE: 440 / 943-5700
FAX: 440 / 943-3129
<http://www.parkerhose.com>

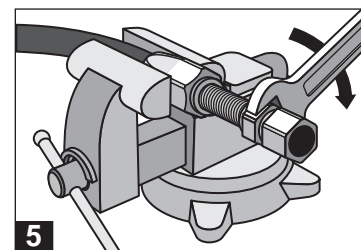
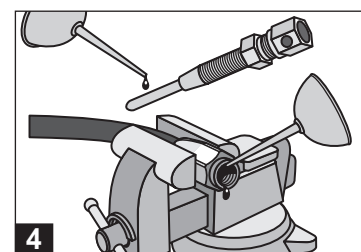
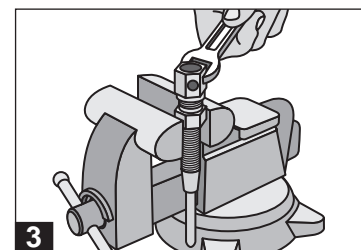
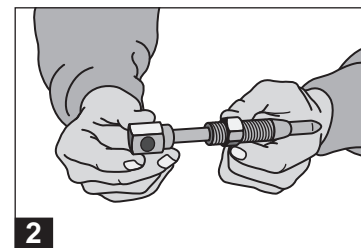
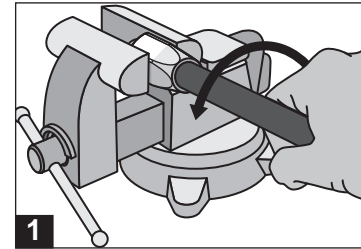

Hose
A

Fittings 22 Series
B

Equipment
C

Accessories
D

Technical
E

Hose
A







Fittings 22 Series
B

Equipment
C

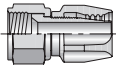
Accessories
D

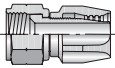
Technical
E

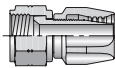

 <p>JIC 37°</p>	<p>20623 B-150</p>  <p><i>Female - Swivel</i></p>	 <p>SAE 45°</p>	<p>20823 B-150</p>  <p><i>Female - Swivel</i></p>	 <p>PTT 30°</p>	<p>23223 B-150</p>  <p><i>Female - Swivel</i></p>
 <p>Assembly Instructions</p>	<p>23 Series B-151 Assembly Instructions</p>				

Hose
A

Fittings 23 Series
B

Equipment
C

Accessories
D

Technical
E

Hose
A

Fittings 23 Series
B

Equipment
C

Accessories
D

Technical
E

20623

Female JIC 37° - Swivel

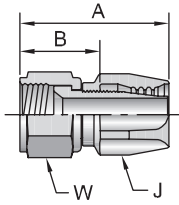

# Part Number	Thread		Hose I.D. inch	A		J		W		B	
	inch	inch		inch	mm	inch	inch	inch	inch	inch	mm
20623-4-4~	1/4	7/16x20	3/16	1.63	41	9/16	9/16	0.96	24		
20623-5-5~	5/16	1/2x20	1/4	1.70	43	5/8	5/8	0.96	24		
20623-6-6	3/8	9/16x18	5/16	1.91	49	3/4	11/16	1.13	29		
20623-8-8~	1/2	3/4x16	13/32	2.16	55	7/8	7/8	1.24	31		
20623-10-10~	5/8	7/8x14	1/2	2.37	60	1-1/16	1	1.37	35		
20623-12-12	3/4	1-1/16x12	5/8	2.51	64	1-1/4	1-1/4	1.43	36		
20623-16-16	1	1-5/16x12	7/8	2.50	64	1-7/16	1-1/2	1.51	38		
20623-20-20	1-1/4	1-5/8x12	1-1/8	2.75	70	1-3/4	2	1.71	43		
20623-24-24	1-1/2	1-7/8x12	1-3/8	3.00	76	2	2-1/4	1.90	48		
20623-32-32	2	2-1/2x12	1-13/16	3.57	91	2-3/8	2-7/8	2.28	58		

~ These 20623 fittings contain a dual seat that accepts both the JIC (37°) and SAE (45°) male configurations. The -6 and -12 SAE (45°) swivel fittings are shown under part number 20823.

20823

Female SAE 45° - Swivel

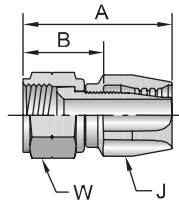

# Part Number	Thread		Hose I.D. inch	A		J		W		B		Additional Material Brass (B)
	inch	inch		inch	mm	inch	inch	inch	mm			
20823-4-4	1/4	7/16x20	3/16	1.68	43	9/16	9/16	1.01	26		•	
20823-6-6	3/8	5/8x18	5/16	1.94	49	3/4	3/4	1.16	29		•	
20823-8-8	1/2	3/4x16	13/32	2.08	53	7/8	7/8	1.16	29		•	
20823-10-10	5/8	7/8x14	1/2	2.33	59	1-1/16	1	1.33	34		•	
20823-12-12	3/4	1-1/16x14	5/8	2.47	63	1-1/4	1-1/4	1.39	35		•	

Notch on nut signifies SAE 45° flared fitting.

23223

Female PTT 30° - Swivel

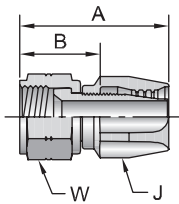

# Part Number	Thread		Hose I.D. inch	A		J		W		B	
	inch	inch		inch	mm	inch	inch	inch	mm		
23223-16-16	1	1-5/16x14	7/8	2.29	58	1-7/16	1-1/2	1.30	33		
23223-20-20	1-1/4	1-5/8x14	1-1/8	2.62	67	1-3/4	2	1.58	40		

23 Series

Mandrel Assembly Instructions

1. Identify over all length (OAL) of hose assembly and the cut off allowance (COA) length of fitting(s) on hose ends by use of the fitting data table. Properly measure, mark and cut hose to desired length using fine tooth hacksaw or a cutoff machine. Care should be taken to ensure a square, clean cut is obtained. Air or solvent flush cut end of hose as necessary to produce a clean hose ID prior to assembly. Place socket in vice and screw in hose counter clockwise until hose bottoms. Back hose out 1/2 turn.
2. When assembling male pipe ends, slide nipple onto mandrel.
3. When assembling swivel ends, slide swivel nut over nipple. Slide nut and nipple onto mandrel. Screw mandrel threads into nipple and wrench tighten.
4. Oil inside of hose and nipple threads liberally with Hoze-Oil. (See Section C). **Do not oil hose cover.**
5. Push nipple into socket.
 - Male ends: Thread nipple in until it bottoms against socket.
 - Swivel ends: Thread nipple into socket using hex on assembly mandrel. Leave clearance of approximately 1/32" (.784mm) between nut and socket to allow nut to swivel. **Remove mandrel.**

Note: Disassemble in reverse order.

Caution: Do Not Attempt to Assemble These Fittings to the Hose Without Using a Mandrel.

Inspection. Examine hose assembly internally for cut or bulged tube, obstructions and cleanliness. Clean ID of hose as necessary. Swivel nuts should turn freely. Check the layline of the hose to be sure the assembly is not twisted. Cap the ends of the assembly to keep clean.

Special Instructions for Refrigerant Hose. Oil inside of hose and nipple threads liberally with the same oil used in refrigeration system. **Do not oil hose cover.** Do not allow hose to contact any petroleum base fluids.

IF YOU HAVE QUESTIONS CONCERNING THE PRODUCTS OR APPLICATION OF THE PRODUCTS CONTAINED IN THIS CATALOG, PLEASE CALL: PARKER HOSE PRODUCTS DIVISION TECHNICAL SERVICES DEPARTMENT

PHONE: 440 / 943-5700

FAX: 440 / 943-3129

<http://www.parkerhose.com>

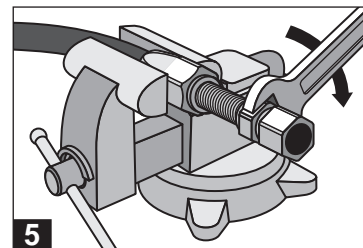
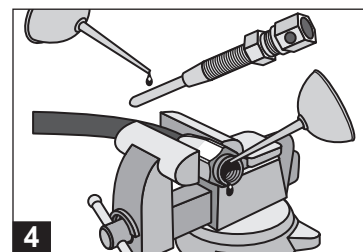
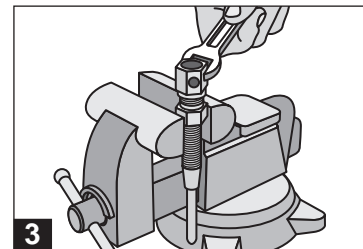
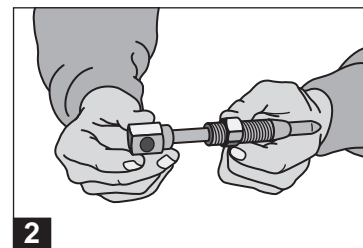
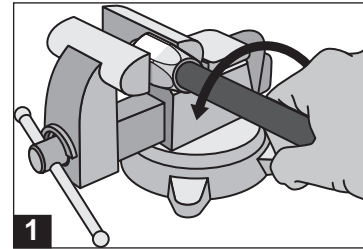

Hose
A

Fittings 23 Series
B

Equipment
C

Accessories
D

Technical
E

Hose
A











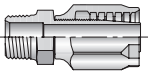
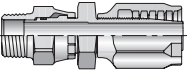

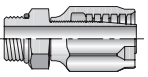
Fittings 23 Series
B

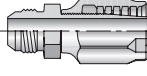
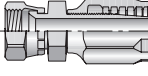
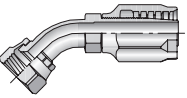
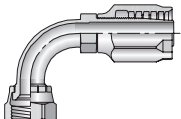
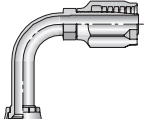
Equipment
C

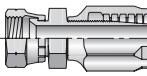
Accessories
D

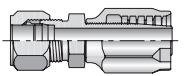
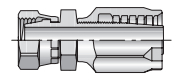
Technical
E

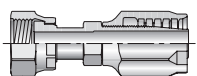
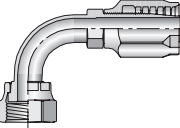

 <p>NPTF Pipe</p>	<p>20130 B-154</p>  <p><i>Male - Rigid</i></p>	<p>21330 B-154</p>  <p><i>Male - Swivel</i></p>	 <p>Straight Thread</p>	<p>20530 B-154</p>  <p><i>Male - Rigid</i></p>	 <p>JIC 37°</p>
<p>20330 B-155</p>  <p><i>Male - Rigid</i></p>	<p>20630 B-155</p>  <p><i>Female - Swivel</i></p>	<p>23730 B-156</p>  <p><i>Female - Swivel 45° Elbow - Short</i></p>	<p>23930 B-156</p>  <p><i>Female - Swivel 90° Elbow - Short</i></p>	<p>24130 B-156</p>  <p><i>Female - Swivel 45° Elbow - Long</i></p>	 <p>SAE</p>
<p>20830 B-156</p>  <p><i>Female - Swivel</i></p>	 <p>Flareless</p>	<p>21130 B-157</p>  <p><i>Male - Rigid</i></p>	<p>21230 B-157</p>  <p><i>Female - Swivel</i></p>	 <p>Seal-Lok® O-Ring Face Seal</p>	<p>2JS30 B-157</p>  <p><i>Female - Swivel Long</i></p>
<p>2J930 B-157</p>  <p><i>Female - Swivel 90° Elbow - Short</i></p>	 <p>Assembly Instructions</p>	<p>30 Series Assembly Instructions B-158</p>			

A	Hose
B	Fittings 30 Series
C	Equipment
D	Accessories
E	Technical

Hose
A

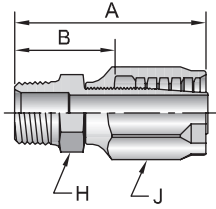

20130 Male NPTF Pipe - Rigid

# Part Number	Thread inch	Hose I.D. inch	A		H inch	J inch	B	
			inch	mm			inch	mm
20130-2-3	1/8x27	3/16	2.01	51	1/2	3/4	1.23	31
20130-2-4	1/8x27	1/4	2.19	56	9/16	3/4	1.23	31
20130-4-4	1/4x18	1/4	2.38	60	9/16	3/4	1.42	36
20130-4-6	1/4x18	3/8	2.58	66	11/16	15/16	1.44	37
20130-6-4	3/8x18	1/4	2.38	60	3/4	3/4	1.41	36
20130-6-6	3/8x18	3/8	2.58	66	3/4	15/16	1.44	37
20130-6-8	3/8x18	1/2	2.92	74	7/8	1-1/16	1.58	40
20130-8-6	1/2x14	3/8	2.77	70	7/8	15/16	1.63	41
20130-8-8	1/2x14	1/2	3.11	79	7/8	1-1/16	1.77	45
20130-12-12	3/4x14	3/4	3.20	81	1-1/8	1-3/8	1.77	45
20130-16-16	1x11-1/2	1	3.74	95	1-3/8	1-3/4	2.03	52
20130-20-20	1-1/4x11-1/2	1-1/4	4.59	117	1-3/4	2-1/4	2.46	62

Fittings 30 Series
B

21330 Male NPTF Pipe - Swivel

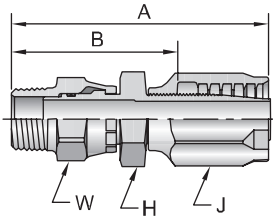

# Part Number	Thread inch	Hose I.D. inch	A		H inch	J inch	W inch	B	
			inch	mm				inch	mm
21330-4-4	1/4x18	1/4	3.42	87	9/16	3/4	5/8	2.46	62
21330-6-6	3/8x18	3/8	3.67	93	7/8	15/16	3/4	2.53	64
21330-8-8	1/2x14	1/2	4.20	107	1	1-1/16	7/8	2.86	73
21330-12-12	3/4x14	3/4	4.30	109	1	1-3/8	1	2.87	73
21330-16-16	1x11-1/2	1	4.93	125	1-1/2	1-3/4	1-1/2	3.22	82

Equipment
C

20530 Male SAE Straight Thread with O-Ring - Rigid

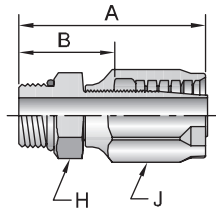

# Part Number	Thread inch	Hose I.D. inch	A		H inch	J inch	B		
			inch	mm			inch	mm	
20530-4-4	1/4	7/16x20	1/4	2.22	56	9/16	3/4	1.26	32
20530-6-6	3/8	9/16x18	3/8	2.45	62	11/16	15/16	1.31	33
20530-8-8	1/2	3/4x16	1/2	2.87	73	7/8	1-1/16	1.53	39

Accessories
D

Technical
E

O-Rings are not compatible with Phosphate Ester fluids.

20330
Male JIC 37° - Rigid

# Part Number	Thread		Hose I.D. inch	A		H inch	J inch	B	
	inch	7/16x20		inch	mm			inch	mm
20330-4-4	1/4	7/16x20	1/4	2.37	60	9/16	3/4	1.41	36
20330-5-4	5/16	1/2x20	1/4	2.37	60	9/16	3/4	1.41	36
20330-6-4	3/8	9/16x18	1/4	2.38	60	5/8	3/4	1.42	36
20330-6-6	3/8	9/16x18	3/8	2.58	66	3/4	15/16	1.44	37
20330-8-6	1/2	3/4x16	3/8	2.68	68	13/16	15/16	1.54	39
20330-8-8	1/2	3/4x16	1/2	3.02	77	7/8	1-1/16	1.68	43
20330-10-8	5/8	7/8x14	1/2	3.12	79	15/16	1-1/16	1.78	45
20330-10-10	5/8	7/8x14	5/8	3.29	84	15/16	1-1/4	1.83	46
20330-12-12	3/4	1-1/16x12	3/4	3.31	84	1-1/8	1-3/8	1.88	48
20330-16-16	1	1-5/16x12	1	3.71	94	1-3/8	1-3/4	2	51

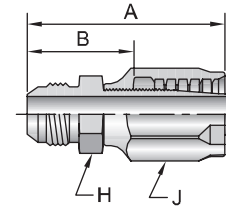

20630
Female JIC 37° - Swivel

# Part Number	Thread		Hose I.D. inch	A		H inch	J inch	W inch	B		Additional Material Stainless Steel (C)
	inch	7/16x20		inch	mm				inch	mm	
20630-4-3	1/4	7/16x20	3/16	2.27	58	9/16	3/4	9/16	1.49	38	
20630-4-4	1/4	7/16x20	1/4	2.45	62	9/16	3/4	9/16	1.49	38	•
20630-5-4	5/16	1/2x20	1/4	2.52	64	5/8	3/4	5/8	1.56	40	
20630-6-4	3/8	9/16x18	1/4	2.54	65	11/16	3/4	11/16	1.58	40	•
20630-6-6	3/8	9/16x18	3/8	2.74	70	11/16	15/16	11/16	1.60	41	•
20630-8-6	1/2	3/4x16	3/8	2.86	73	7/8	15/16	7/8	1.72	44	•
20630-8-8	1/2	3/4x16	1/2	3.20	81	7/8	1-1/16	7/8	1.86	47	•
20630-10-8	5/8	7/8x14	1/2	3.30	84	1	1-1/16	1	1.96	50	
20630-10-10	5/8	7/8x14	5/8	3.54	90	1	1-1/4	1	2.08	53	
20630-10-12	5/8	7/8x14	3/4	3.40	86	1-1/8	1-3/8	1	1.97	50	
20630-12-8	3/4	1-1/16x12	1/2	3.47	88	1-1/4	1-1/16	1-1/4	2.13	54	
20630-12-10	3/4	1-1/16x12	5/8	3.64	92	1-1/4	1-1/4	1-1/4	2.18	55	
20630-12-12	3/4	1-1/16x12	3/4	3.50	89	1-1/4	1-3/8	1-1/4	2.07	53	•
20630-14-12	7/8	1-3/16x12	3/4	3.50	89	1-3/8	1-3/8	1-3/8	2.07	53	
20630-16-12	1	1-5/16x12	3/4	3.59	91	1-1/2	1-3/4	1-1/2	2.16	55	
20630-16-16	1	1-5/16x12	1	3.94	100	1-1/2	1-3/4	1-1/2	2.23	57	
20630-20-16	1-1/4	1-5/8x12	1	4.17	106	2	1-3/4	2	2.46	62	
20630-20-20	1-1/4	1-5/8x12	1-1/4	4.96	126	2	2-1/4	2	2.83	72	
20630-24-24	1-1/2	1-7/8x12	1-1/2	5.26	134	2-1/4	2-1/2	2-1/4	3.05	77	
20630-32-32	2	2-1/2x12	2	6.42	163	2-7/8	3	2-7/8	3.92	100	

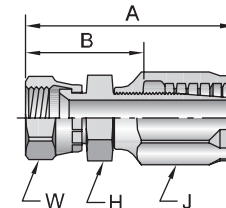

Hose
A

Fittings 30 Series
B

Equipment
C

Accessories
D

Technical
E

Hose
A

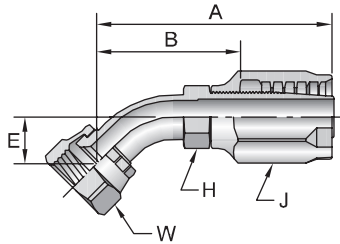

23730

Female JIC 37° - Swivel - 45° Elbow - Short Drop

# Part Number	Thread inch	Hose I.D. inch	A		E		H	J	W	B		
			inch	mm	inch	mm	inch	inch	inch	inch	mm	
23730-4-4	1/4	7/16x20	1/4	2.70	69	0.33	8	7/16	3/4	9/16	1.74	44
23730-6-6	3/8	9/16x18	3/8	3.01	76	0.39	10	9/16	15/16	11/16	1.87	47
23730-8-8	1/2	3/4x16	1/2	3.55	90	0.55	14	11/16	1-1/16	7/8	2.21	56
23730-10-8	5/8	7/8x14	1/2	3.61	92	0.65	17	13/16	1-1/16	1	2.27	58
23730-12-12	3/4	1-1/16x12	3/4	3.93	100	0.79	20	15/16	1-3/8	1-1/4	2.50	64
23730-16-16	1	1-5/16x12	1	4.51	115	0.90	23	1-1/4	1-3/4	1-1/2	2.80	71

Fittings 30 Series
B

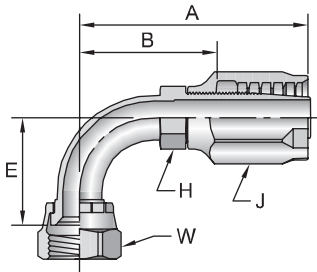

23930

Female JIC 37° - Swivel - 90° Elbow - Short Drop

# Part Number	Thread inch	Hose I.D. inch	A		E		H	J	W	B		
			inch	mm	inch	mm	inch	inch	inch	inch	mm	
23930-4-4	1/4	7/16x20	1/4	2.52	64	0.83	21	7/16	3/4	9/16	1.56	40
23930-6-6	3/8	9/16x18	3/8	2.91	74	0.85	22	9/16	15/16	11/16	1.77	45
23930-8-6	1/2	3/4x16	3/8	3.04	77	1.09	28	11/16	15/16	7/8	1.90	48
23930-8-8	1/2	3/4x16	1/2	3.32	84	1.09	28	11/16	1-1/16	7/8	1.98	50
23930-10-8	5/8	7/8x14	1/2	3.46	88	1.24	31	13/16	1-1/16	1	2.12	54
23930-12-12	3/4	1-1/16x12	3/4	3.86	98	1.81	46	15/16	1-3/8	1-1/4	2.43	62
23930-16-16	1	1-5/16x12	1	4.48	114	2.14	54	1-1/4	1-3/4	1-1/2	2.77	70

Equipment
C

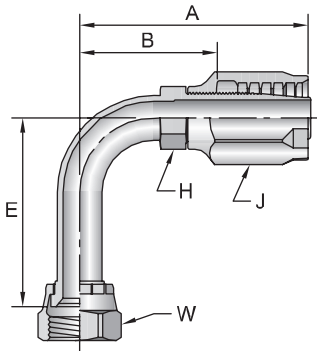

24130

Female JIC 37° - Swivel - 90° Elbow - Long Drop

# Part Number	Thread inch	Hose I.D. inch	A		E		H	J	W	B		
			inch	mm	inch	mm	inch	inch	inch	inch	mm	
24130-6-6	3/8	9/16x18	3/8	2.90	74	2.18	55	9/16	15/16	11/16	1.76	45
24130-8-8	1/2	3/4x16	1/2	3.39	86	2.43	62	11/16	1-1/16	7/8	2.05	52

Accessories
D

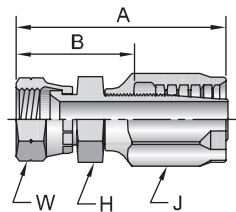

20830

Female SAE 45° - Swivel

# Part Number	Thread inch	Hose I.D. inch	A		H	J	W	B		
			inch	mm	inch	inch	inch	inch	mm	
20830-6-6	3/8	5/8x18	3/8	2.81	71	3/4	15/16	3/4	1.67	42

Notch on nut signifies SAE 45° flare.

Technical
E

21130

Male Ferulok Flareless - Rigid - (24° Cone with Nut and Ferrule)

# Part Number	Thread		Hose I.D.		A		H	J	W	B	
	inch		inch	mm	inch	mm	inch	inch	inch	inch	mm
21130-16-16	1	1-5/16x12	1	4.15	105	1-3/8	1-3/4	1-1/2	2.44	62	

The Parker Ferrul-Fix fitting makes it possible to salvage the bent tube section from a hose assembly for quick, easy on-the-job repairs. For additional information see Ferrule-Fix installation instructions in the Technical Section.

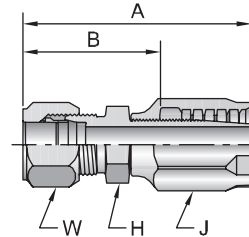

21230

Female Ferulok Flareless - Swivel - (24° Cone)

# Part Number	Thread		Hose I.D.		A		H	J	W	B	
	inch		inch	mm	inch	mm	inch	inch	inch	inch	mm
21230-4-4	1/4	7/16x20	1/4	2.62	67	9/16	3/4	9/16	1.66	42	
21230-6-6	3/8	9/16x18	3/8	2.94	75	11/16	15/16	11/16	1.80	46	
21230-8-6	1/2	3/4x16	3/8	3.16	80	7/8	15/16	7/8	2.02	51	
21230-8-8	1/2	3/4x16	1/2	3.44	87	7/8	1-1/16	7/8	2.10	53	
21230-12-12	3/4	1-1/16x12	3/4	3.86	98	1-1/4	1-3/8	1-1/4	2.43	62	

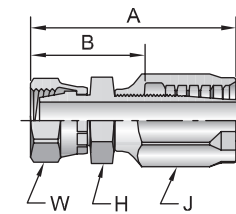

2JS30

Female Seal-Lok® - Swivel - Long ISO 12151-1 - SWSB

# Part Number	Thread		Hose I.D.		A		H	J	W	B	
	inch		inch	mm	inch	mm	inch	inch	inch	inch	mm
2JS30-4-4	1/4	9/16x18	1/4	2.62	67	9/16	3/4	11/16	1.66	42	
2JS30-6-6	3/8	11/16x16	3/8	2.89	73	9/16	15/16	13/16	1.75	44	
2JS30-8-8	1/2	13/16x16	1/2	3.32	84	11/16	1-1/16	15/16	1.98	50	
2JS30-12-12	3/4	1-3/16x12	3/4	3.65	93	15/16	1-3/8	1-3/8	2.22	56	

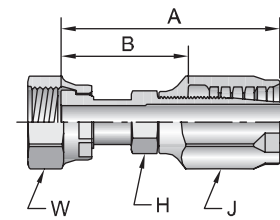

2J930

Female Seal-Lok® - Swivel - 90° Elbow - Short Drop ISO 12151-1 - SWES90

# Part Number	Thread		Hose I.D.		A		E		H	J	W	B	
	inch		inch	mm	inch	mm	inch	mm	inch	inch	inch	inch	mm
2J930-4-4	1/4	9/16x18	1/4	2.83	72	0.82	21	7/16	3/4	11/16	1.87	47	
2J930-6-6	3/8	11/16x16	3/8	2.91	74	0.90	23	9/16	15/16	13/16	1.77	45	
2J930-8-8	1/2	13/16x16	1/2	3.31	84	1.15	29	11/16	1-1/16	15/16	1.97	50	
2J930-10-10	5/8	1x14	5/8	3.57	91	1.27	32	7/8	1-1/4	1-1/8	2.11	54	
2J930-12-12	3/4	1-3/16x12	3/4	3.71	94	1.85	47	15/16	1-3/8	1-3/8	2.28	58	

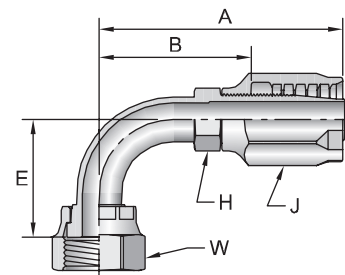

See Accessories Section for O-Rings.

30 Series Hose Assembly Instructions

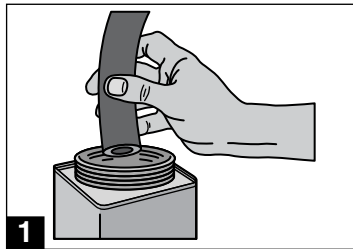

1. Identify over all length (OAL) of hose assembly and the cut off allowance (COA) length of fitting(s) on hose ends by use of the fitting data table. Properly measure, mark and cut hose to desired length using fine tooth hacksaw or a cutoff machine. Dip hose end into Hoze-Oil (See Section C) or heavy oil.

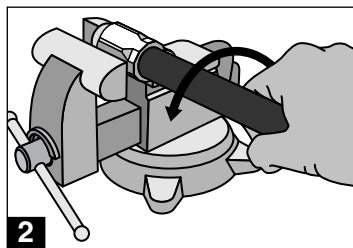

2. Place socket in vice and screw in hose counter-clockwise until hose bottoms. Back hose out 1/2 turn.

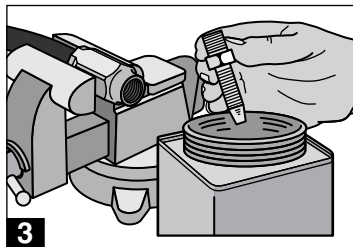

3. Dip hose end of nipple into Hoze-Oil or other heavy oil up to the hex. When assembling fittings of 316 stainless steel lubricate the threads of both the socket and nipple with Dow Corning Molykote G-n or equivalent metal assembly lubricant.

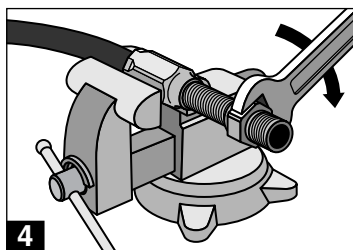

4. Screw nipple assembly into socket using wrench on nipple hex until nipple hex shoulders against socket.











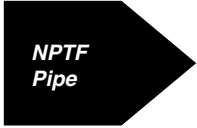
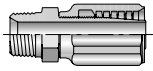
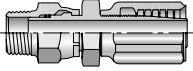

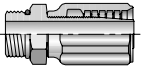
Note: Disassemble in reverse order.

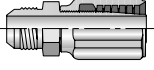
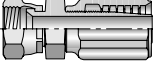
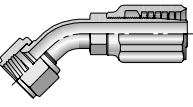
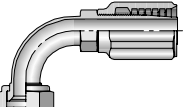
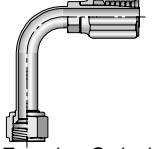
IF YOU HAVE QUESTIONS CONCERNING THE PRODUCTS
OR APPLICATION OF THE PRODUCTS CONTAINED IN THIS
CATALOG, PLEASE CALL: PARKER HOSE PRODUCTS
DIVISION TECHNICAL SERVICES DEPARTMENT

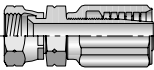
PHONE: 440 / 943-5700

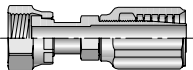
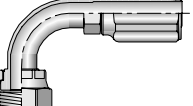
FAX: 440 / 943-3129

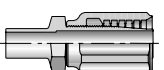
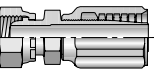
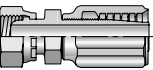
<http://www.parkerhose.com>

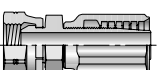
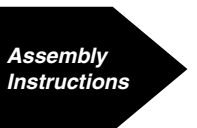
 NPTF Pipe	20142 B-160  <i>Male - Rigid</i>	21342 B-160  <i>Male - Swivel</i>	 SAE	20542 B-160  <i>Male - Rigid</i>	 JIC 37°
20342 B-161  <i>Male - Rigid</i>	20642 B-161  <i>Female - Swivel</i>	23742 B-162  <i>Female - Swivel 45° Elbow - Short</i>	23942 B-162  <i>Female - Swivel 90° Elbow - Short</i>	24142 B-162  <i>Female - Swivel 45° Elbow - Long</i>	 SAE
20842 B-162  <i>Female - Swivel</i>	 Seal-Lok® O-Ring Face Seal	2JS42 B-163  <i>Female - Swivel Long</i>	2J942 B-163  <i>Female - Swivel 90° Elbow - Short</i>	 Metric L & S	21D42 B-163  <i>Male Standpipe Rigid</i>
2C342 B-164  <i>Female - Swivel</i>	2C642 B-164  <i>Female - Swivel</i>	 BSP	29242 B-164  <i>Female - Swivel</i>	 Assembly Instructions	42 Series Assembly Instructions B-165

Hose
A

Fittings 42 Series
B

Equipment
C

Accessories
D

Technical
E

Hose
A

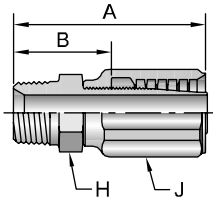

20142 Male NPTF Pipe - Rigid

# Part Number	Thread inch	Hose I.D. inch	A		H inch	J inch	B	
			inch	mm			inch	mm
20142-2-3	1/8x27	3/16	2.09	53	1/2	5/8	1.31	33
20142-2-4	1/8x27	1/4	2.17	55	9/16	11/16	1.25	32
20142-4-3	1/4x18	3/16	2.28	58	9/16	5/8	1.50	38
20142-4-4	1/4x18	1/4	2.36	60	9/16	11/16	1.44	37
20142-4-5	1/4x18	5/16	2.39	61	9/16	13/16	1.44	37
20142-4-6	1/4x18	3/8	2.60	66	11/16	7/8	1.45	37
20142-6-6	3/8x18	3/8	2.60	66	3/4	7/8	1.45	37
20142-8-8	1/2x14	1/2	3.02	77	7/8	1	1.69	43
20142-8-10	1/2x14	5/8	3.29	84	15/16	1-1/8	1.87	47
20142-12-12	3/4x14	3/4	3.23	82	1-1/8	1-3/8	1.75	44
20142-16-16	1x11-1/2	1	3.61	92	1-3/8	1-5/8	2.07	53

Fittings 42 Series
B

21342 Male NPTF Pipe - Swivel

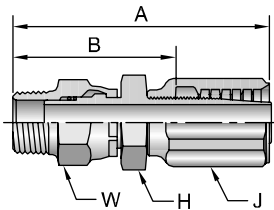

# Part Number	Thread inch	Hose I.D. inch	A		H inch	J inch	W inch	B	
			inch	mm				inch	mm
21342-4-4	1/4x18	1/4	3.40	86	9/16	11/16	5/8	2.48	63
21342-6-6	3/8x18	3/8	3.69	94	7/8	7/8	3/4	2.54	65

Equipment
C

20542 Male SAE Straight Thread with O-Ring - Rigid

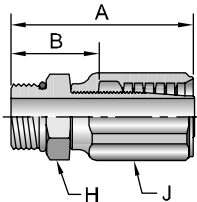

# Part Number	Thread inch	Hose I.D. inch	A		H inch	J inch	B	
			inch	mm			inch	mm
20542-4-4	1/4 7/16X20	1/4	2.2	56	9/16	11/16	1.28	33
20542-6-6	3/8 9/16x18	3/8	2.47	63	11/16	7/8	1.32	34
20542-8-8	1/2 3/4X16	1/2	2.78	71	7/8	1	1.45	37

Accessories
D

Technical
E

O-Rings are not compatible with Phosphate Ester fluids.

20342
Male JIC 37° - Rigid

# Part Number	Thread		Hose I.D. inch	A		H inch	J inch	B	
	inch	inch		inch	mm			inch	mm
20342-4-4	1/4	7/16x20	1/4	2.35	60	9/16	11/16	1.43	36
20342-6-4	3/8	9/16x18	1/4	2.36	60	5/8	11/16	1.44	36
20342-6-5	3/8	9/16x18	5/16	2.39	61	5/8	13/16	1.43	36
20342-6-6	3/8	9/16x18	3/8	2.60	66	3/4	7/8	1.45	37
20342-8-6	1/2	3/4x16	3/8	2.70	69	13/16	7/8	1.55	39
20342-8-8	1/2	3/4x16	1/2	2.93	74	7/8	1	1.60	41
20342-10-10	5/8	7/8x14	5/8	3.24	82	15/16	1-1/8	1.82	46
20342-12-12	3/4	1-1/16x12	3/4	3.34	85	1-1/8	1-3/8	1.86	47
20342-16-16	1	1-5/16x12	1	3.58	91	1-3/8	1-5/8	2.04	52

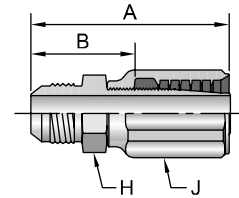

20642
Female JIC 37° - Swivel

# Part Number	Thread		Hose I.D. inch	A		H inch	J inch	W inch	B		Additional Material Stainless Steel (C)
	inch	inch		inch	mm				inch	mm	
20642-4-3	1/4	7/16x20	3/16	2.34	59	9/16	5/8	9/16	1.56	40	
20642-4-4	1/4	7/16x20	1/4	2.43	62	9/16	11/16	9/16	1.51	38	
20642-5-4	5/16	1/2x20	1/4	2.50	64	5/8	11/16	5/8	1.58	40	
20642-6-4	3/8	9/16x18	1/4	2.52	64	11/16	11/16	11/16	1.60	41	
20642-6-5	3/8	9/16x18	5/16	2.55	65	11/16	13/16	11/16	1.60	41	
20642-6-6	3/8	9/16x18	3/8	2.76	70	11/16	7/8	11/16	1.61	41	•
20642-8-6	1/2	3/4x16	3/8	2.88	73	7/8	7/8	7/8	1.73	44	
20642-8-8	1/2	3/4x16	1/2	3.11	79	7/8	1	7/8	1.78	45	•
20642-10-8	5/8	7/8x14	1/2	3.21	82	1	1	1	1.88	48	
20642-10-10	5/8	7/8x14	5/8	3.49	89	1	1-1/8	1	2.07	53	
20642-10-12	5/8	7/8x14	3/4	3.43	87	1-1/8	1-3/8	1	1.95	50	
20642-12-12	3/4	1-1/16x12	3/4	3.53	90	1-1/4	1-3/8	1-1/4	2.05	52	
20642-16-12	1	1-5/16x12	3/4	3.62	92	1-1/2	1-3/8	1-1/2	2.14	54	
20642-16-16	1	1-5/16x12	1	3.81	97	1-1/2	1-5/8	1-1/2	2.27	58	
20642-20-16	1-1/4	1-5/8x12	1	4.04	103	2	1-5/8	2	2.50	64	

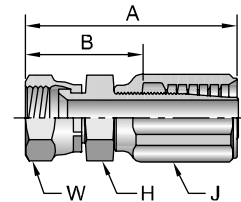

Hose
A

Fittings 42 Series
B

Equipment
C

Accessories
D

Technical
E

Hose
A

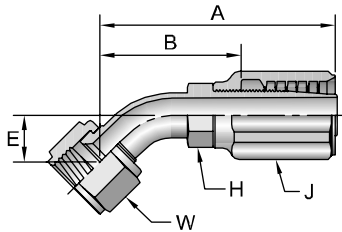

23742

Female JIC 37° - Swivel - 45° Elbow - Short Drop

# Part Number	Thread inch	Hose I.D. inch	A		E		H inch	J inch	W inch	B		
			inch	mm	inch	mm				inch	mm	
23742-4-4	1/4	7/16x20	1/4	2.68	68	0.33	8	7/16	11/16	9/16	1.76	45
23742-6-6	3/8	9/16x18	3/8	3.03	77	0.39	10	9/16	7/8	11/16	1.88	48
23742-8-8	1/2	3/4x16	1/2	3.46	88	0.55	14	11/16	1	7/8	2.13	54
23742-16-16	1	1-5/16x12	1	4.38	111	0.90	23	1-1/4	1-5/8	1-1/2	2.84	72

Fittings 42 Series
B

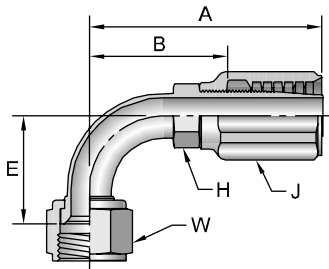

23942

Female JIC 37° - Swivel - 90° Elbow - Short Drop

# Part Number	Thread inch	Hose I.D. inch	A		E		H inch	J inch	W inch	B		
			inch	mm	inch	mm				inch	mm	
23942-4-4	1/4	7/16x20	1/4	2.50	64	0.83	21	7/16	11/16	9/16	1.58	40
23942-6-6	3/8	9/16x18	3/8	2.93	74	0.85	22	9/16	7/8	11/16	1.78	45
23942-8-6	1/2	3/4x16	3/8	3.06	78	1.09	28	11/16	7/8	7/8	1.91	49
23942-8-8	1/2	3/4x16	1/2	3.22	82	1.09	28	11/16	1	7/8	1.90	48
23942-10-8	5/8	7/8x14	1/2	3.37	86	1.24	31	13/16	1	1	2.04	52
23942-12-12	3/4	1-1/16x12	3/4	3.89	99	1.81	46	15/16	1-3/8	1-1/4	2.41	61
23942-16-16	1	1-5/16x12	1	4.35	110	2.14	54	1-1/4	1-5/8	1-1/2	2.81	71

Equipment
C

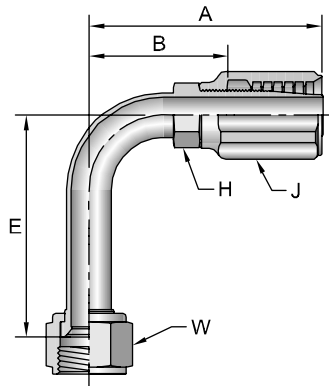

24142

Female JIC 37° - Swivel - 90° Elbow - Long Drop

# Part Number	Thread inch	Hose I.D. inch	A		E		H inch	J inch	W inch	B		
			inch	mm	inch	mm				inch	mm	
24142-6-6	3/8	9/16x18	3/8	2.92	74	2.18	55	9/16	7/8	11/16	1.77	45
24142-8-8	1/2	3/4x16	1/2	3.30	84	2.43	62	11/16	1	7/8	1.97	50
24142-10-8	5/8	7/8x14	1/2	3.44	87	2.57	65	13/16	1	1	2.11	54

Accessories
D

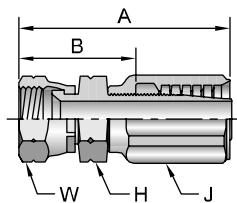

20842

Female SAE 45° - Swivel

# Part Number	Thread inch	Hose I.D. inch	A		H inch	J inch	W inch	B		
			inch	mm				inch	mm	
20842-6-6	3/8	5/8x18	3/8	2.82	72	3/4	7/8	3/4	1.67	42

Notch on nut signifies SAE 45° flare.

Technical
E

2JS42

Female Seal-Lok® - Swivel - Long

ISO - 12151-1 - SWSB

# Part Number	Thread		Hose I.D.		A		H	J	W	B	
	inch	inch	inch	mm	inch	mm	inch	inch	inch	inch	mm
2JS42-4-4	1/4	9/16-18	1/4	2.60	66	9/16	11/16	11/16	1.68	43	
2JS42-6-6	3/8	11/16x16	3/8	2.91	74	9/16	7/8	13/16	1.76	45	
2JS42-8-8	1/2	13/16x16	1/2	3.23	82	11/16	1	15/16	1.90	48	

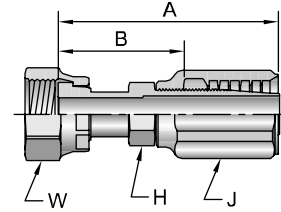

2J942

Female Seal-Lok® - Swivel - 90° Elbow - Short Drop

ISO 12151-1 - SWES90

# Part Number	Thread		Hose I.D.		A		E		H	J	W	B	
	inch	inch	inch	mm	inch	mm	inch	mm	inch	inch	inch	inch	mm
2J942-4-4	1/4	9/16x18	1/4	2.81	71	0.78	20	7/16	11/16	11/16	1.89	48	
2J942-6-6	3/8	11/16x16	3/8	2.93	74	0.90	23	9/16	7/8	13/16	1.78	45	
2J942-8-8	1/2	13/16x16	1/2	3.22	82	1.15	29	11/16	1	15/16	1.89	48	

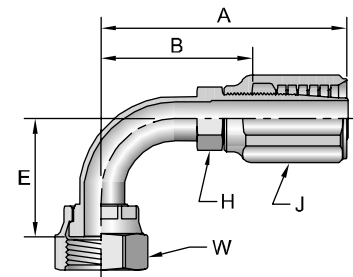

21D42

Male Standpipe Metric L - Rigid

ISO 8434-1

# Part Number	R	Hose I.D.		A		D		H	J	B	
	mm	inch	inch	mm	mm	inch	mm	mm	inch	inch	mm
21D42-6-4	6	1/4	2.56	65	0.87	22	14	11/16	1.57	40	
21D42-8-4	8	1/4	2.56	65	0.87	22	14	11/16	1.57	40	
21D42-10-5	10	5/16	2.68	68	0.91	23	14	13/16	1.65	42	
21D42-10-6	10	3/8	2.80	71	0.91	23	17	7/8	1.65	42	
21D42-12-6	12	3/4	2.80	71	0.91	23	17	7/8	1.65	42	
21D42-15-8	15	1/2	3.15	80	0.98	25	19	1	1.89	48	
21D42-18-10	18	5/8	3.46	88	1.02	26	24	1-1/8	2.09	53	
21D42-18-12	18	3/4	3.39	86	1.02	26	27	1-3/8	1.81	46	
21D42-22-12	22	3/4	3.46	88	1.10	28	27	1-3/8	1.89	48	
21D42-28-16	28	1	4.09	104	1.18	30	32	1-5/8	2.28	58	

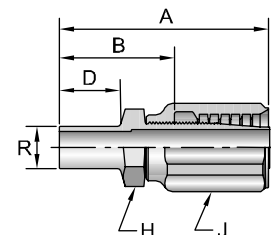

Metric L: Mates with EO "L" Series Fittings.
See Accessories Section for O-Rings.

Hose
A

Fittings 42 Series
B

Equipment
C

Accessories
D

Technical
E

2C342
Female Metric L - Swivel - (Ball Nose)
ISO 8434-1

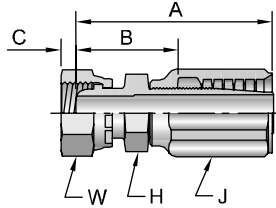

# Part Number	Thread mm	Hose I.D. inch	A		C		H mm	J inch	W mm	B	
			inch	mm	inch	mm				inch	mm
2C342-6-4	6 M12x1,5	1/4	2.40	61	0.09	2	14	11/16	14	1.42	36
2C342-8-4	8 M14x1,5	1/4	2.44	62	0.11	3	14	11/16	17	1.46	37
2C342-10-5	10 M16x1,5	5/16	2.91	74	0.06	2	17	13/16	19	1.91	49
2C342-10-6	10 M16x1,5	3/8	2.83	72	0.06	2	17	7/8	19	1.74	44
2C342-12-6	12 M18x1,5	3/8	2.72	69	0.10	3	19	7/8	22	1.63	41
2C342-15-8	15 M22x1,5	1/2	3.11	79	0.17	4	22	1	27	1.81	46
2C342-18-10	18 M26x1,5	5/8	3.39	86	0.10	3	27	1-1/8	32	1.97	50
2C342-18-12	18 M26x1,5	3/4	3.31	84	0.10	3	27	1-3/8	32	1.76	45
2C342-22-12	22 M30x2	3/4	3.58	91	0.18	5	30	1-3/8	36	2.03	52
2C342-28-16	28 M36x2	1	4.25	108	0.22	6	36	1-5/8	46	2.59	66

2C642
Female Metric S - Swivel - (Ball Nose)
ISO 8434-1

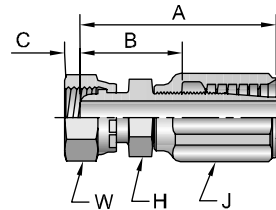

# Part Number	Thread mm	Hose I.D. inch	A		C		H mm	J inch	W mm	B	
			inch	mm	inch	mm				inch	mm
2C642-12-6	12 M20x1,5	3/8	2.72	69	0.08	2	19	7/8	24	1.61	41

29242
Female BSP Parallel Pipe - Swivel - (60° Cone)
ISO 228-1

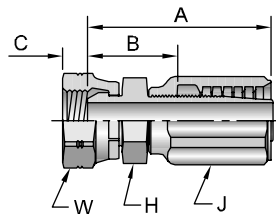

# Part Number	Thread inch	Hose I.D. inch	A		C		H mm	J inch	W mm	B	
			inch	mm	inch	mm				inch	mm
29242-8-8	1/2x14	1/2	3.31	84	0.28	7	22	1	27	2.01	51

Metric L: Mates with EO "L" Series Fittings.
Metric S: Mates with EO "S" Series Fittings.

When measuring overall length to the end of the nut, B+C dimensions must be used to calculate cut-off allowance.

42 Series Hose Assembly Instructions

1. Identify over all length (OAL) of hose assembly and the cut off allowance (COA) length of fitting(s) on hose ends by use of the fitting data table. Properly measure, mark and cut hose to desired length using fine tooth hacksaw or a cutoff machine. Dip hose end into Hoze-Oil (See Section C) or heavy oil.
2. Place socket in vice and screw in hose counter-clockwise until hose bottoms. Back hose out 1/2 turn.
3. Dip hose end of nipple into Hoze-Oil or other heavy oil up to the hex. When assembling fittings of 316 stainless steel lubricate the threads of both the socket and nipple with Dow Corning Molykote G-n or equivalent metal assembly lubricant.
4. Screw assembly into socket using wrench on nipple hex until nipple hex shoulders against socket.

Note: Disassemble in reverse order.

IF YOU HAVE QUESTIONS CONCERNING THE PRODUCTS
OR APPLICATION OF THE PRODUCTS CONTAINED IN THIS
CATALOG, PLEASE CALL:
PARKER HOSE PRODUCTS DIVISION
TECHNICAL SERVICES DEPARTMENT
PHONE: 440 / 943-5700
FAX: 440 / 943-3129
<http://www.parkerhose.com>

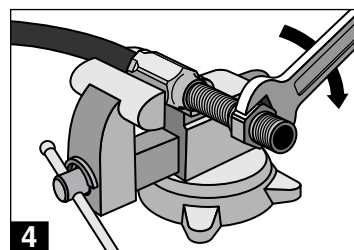
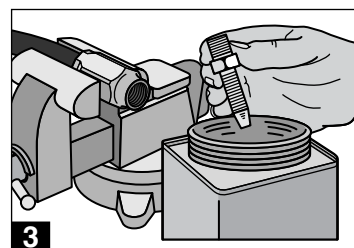
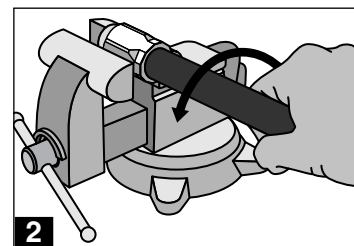
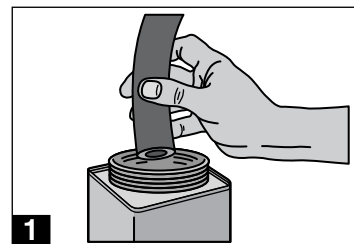

Hose
A

Fittings 42 Series
B

Equipment
C

Accessories
D

Technical
E











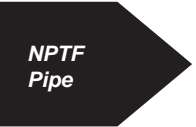
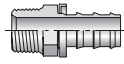
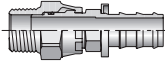
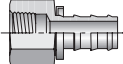

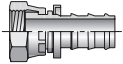



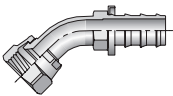
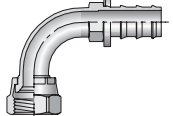
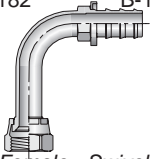

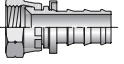
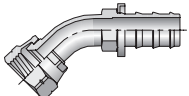
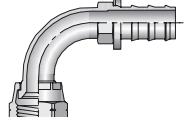

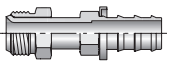
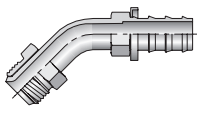
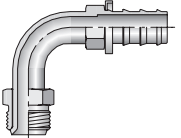

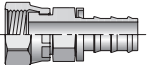
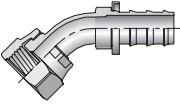
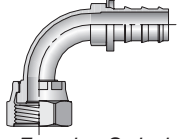
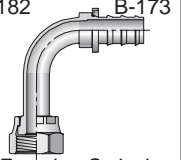

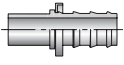

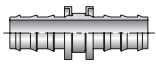

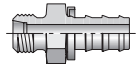
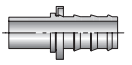

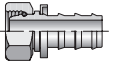
Hose
A

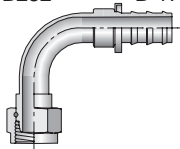
Fittings 82 Series
B

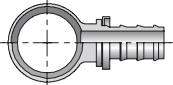
Equipment
C

Accessories
D

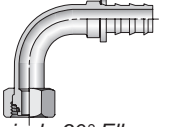
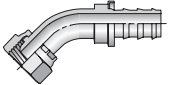
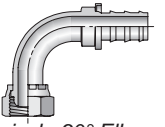
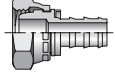
Technical
E

 NPTF Pipe	30182 B-168  <i>Male - Rigid</i>	31382 B-168  <i>Male - Swivel</i>	30282 B-169  <i>Female - Rigid</i>	 NPSM Pipe	37G82 B-169  <i>Female - Swivel Gasket Joint</i>
 JIC 37°	30382 B-169  <i>Male - Rigid</i>	30682 B-170  <i>Female - Swivel</i>	33782 B-170  <i>Female - Swivel 45° Elbow - Short</i>	33982 B-170  <i>Female - Swivel 90° Elbow - Short</i>	34182 B-170  <i>Female - Swivel 90° Elbow - Long</i>
 SAE	30482 B-171  <i>Male - Rigid</i>	30882 B-171  <i>Female - Swivel</i>	37782 B-171  <i>Female - Swivel 45° Elbow</i>	37982 B-171  <i>Female - Swivel 90° Elbow</i>	 Inverted SAE
32882 B-172  <i>Male - Swivel</i>	36782 B-172  <i>Male - Swivel 45° Elbow</i>	36982 B-172  <i>Male - Swivel 90° Elbow</i>	32982 B-172  <i>Female - Rigid</i>	 Seal-Lok® O-Ring Face Seal	3JC82 B-173  <i>Female - Swivel Short</i>
3J782 B-173  <i>Female - Swivel 45° Elbow</i>	3J982 B-173  <i>Female - Swivel 90° Elbow - Short</i>	3J182 B-173  <i>Female - Swivel 90° Elbow - Long</i>	 Standpipe	33482 B-174  <i>Male - Rigid</i>	 Union
38282 B-174  <i>Push-Lok Union</i>	 Metric L	3D082 B-174  <i>Male - Rigid</i>	31D82 B-175  <i>Male Standpipe Rigid</i>	 BSP	39282 B-175  <i>Female - Swivel</i>
3D982 B-175  <i>Male - Rigid</i>	3B282 B-175  <i>Female - Swivel 90° Elbow</i>	 Banjo	34982 B-176  <i>Metric - Banjo</i>	AM B-176  <i>Banjo Bolt</i>	 Metric L Swivels
3CA82 B-177  <i>Swivel - 24° Cone</i>	3CF82 B-177  <i>Swivel - 90° Elbow - 24° Cone</i>	3C482 B-177  <i>Swivel - 45° Elbow - Ball Nose</i>	3C582 B-178  <i>Swivel - 90° Elbow - Ball Nose</i>	3C382 B-178  <i>Swivel - Ball Nose</i>	 Kits

Push-Lok Kits B-179 <i>Push-Lok Hose and Fitting Kits</i>	Push-Lok Merchandiser B-180 <i>Push-Lok Hose and Fitting Display Case</i>	 <p>Assembly Instructions</p>	82 Series Assembly Instructions B-181
---	---	---	--

Hose A
Fittings 82 Series B
Equipment C
Accessories D
Technical E

Hose
A

Fittings 82 Series
B

Equipment
C

Accessories
D

Technical
E

30182 Male NPTF Pipe - Rigid

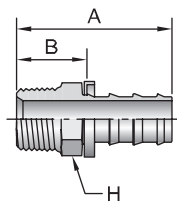

# Part Number	Thread inch	Hose I.D. inch	A		H inch	B		Additional Material	
			inch	mm		inch	mm	Brass (B)	Stainless Steel (C)
30182-2-4	1/8x27	1/4	1.39	35	7/16	0.64	16	•	•
30182-4-4	1/4x18	1/4	1.57	40	9/16	0.82	21	•	•
30182-4-6	1/4x18	3/8	1.78	45	9/16	0.88	22	•	•
30182-4-8	1/4x18	1/2	1.93	49	5/8	0.88	22	•	•
30182-6-6	3/8x18	3/8	1.78	45	11/16	0.88	22	•	•
30182-6-8	3/8x18	1/2	1.93	49	11/16	0.88	22	•	•
30182-8-6	1/2x14	3/8	2.03	52	7/8	1.13	29	•	•
30182-8-8	1/2x14	1/2	2.18	55	7/8	1.13	29	•	•
30182-8-10	1/2x14	5/8	2.58	66	7/8	1.13	29	•	•
30182-8-12	1/2x14	3/4	2.58	66	7/8	1.13	29	•	•
30182-12-8	3/4x14	1/2	2.21	56	3/4	1.16	29	•	•
30182-12-10	3/4x14	5/8	2.61	66	1-1/16	1.16	29	•	•
30182-12-12	3/4x14	3/4	2.61	66	1-1/16	1.16	29	•	•
30182-16-16	1x11-1/2	1	3.06	78	1-3/8	1.61	41	•	•

31382 Male NPTF Pipe - Swivel

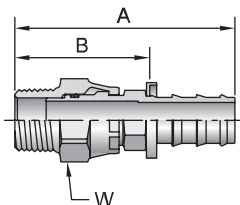

# Part Number	Thread inch	Hose I.D. inch	A		W inch	B		Additional Material Brass (B)
			inch	mm		inch	mm	
31382-4-4	1/4x18	1/4	1.60	41	9/16	0.85	22	
31382-6-6	3/8x18	3/8	1.79	45	11/16	0.89	23	
31382-8-8	1/2x14	1/2	2.20	56	7/8	1.15	29	
31382-8-10	1/2x14	5/8	3.50	90	7/8	2.05	52	•
31382-12-12	3/4x14	3/4	3.70	94	1-1/4	2.25	57	

O-Ring not compatible with Phosphate Ester fluids.

30282

Female NPTF Pipe - Rigid

# Part Number	Thread inch	Hose I.D. inch	A		H inch	B		Additional Material Brass (B)
			inch	mm		inch	mm	
30282-4-4	1/4x18	1/4	1.56	40	3/4	0.81	21	•
30282-6-6	3/8x18	3/8	1.82	46	7/8	0.92	23	•
30282-8-8	1/2x14	1/2	2.16	55	1-1/16	1.11	28	•

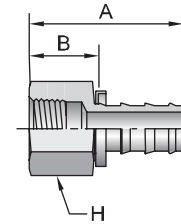

37G82

Female NPSM Pipe - Gasket Joint - Swivel

# Part Number	Gasket	Thread inch	Hose I.D. inch	A		W inch	B	
				inch	mm		inch	mm
37G82-4-4	07G-4	1/4x18	1/4	1.55	39	11/16	0.80	20
37G82-4-6	07G-4	1/4x18	3/8	1.70	43	11/16	0.80	20
37G82-6-6	07G-6	3/8x18	3/8	1.75	44	7/8	0.85	22
37G82-8-8	07G-8	1/2x14	1/2	2.07	53	1	1.02	26
37G82-8-10	07G-8	1/2x14	5/8	2.47	63	1	1.02	26
37G82-12-12	07G-12	3/4x14	3/4	2.54	65	1-1/4	1.09	28

Textile gasket included with fitting.

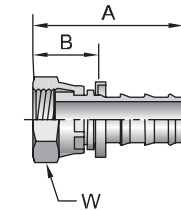

30382

Male JIC 37° - Rigid

# Part Number	Thread inch	Hose I.D. inch	A		H inch	B		Additional Material Brass (B)
			inch	mm		inch	mm	
30382-4-4	1/4 7/16x20	1/4	1.56	40	1/2	0.81	21	
30382-5-4	5/16 1/2x20	1/4	1.59	40	9/16	0.84	21	
30382-6-6	3/8 9/16x18	3/8	1.78	45	5/8	0.88	22	•
30382-8-8	1/2 3/4x16	1/2	2.06	52	3/4	1.01	26	
30382-10-10	5/8 7/8x14	5/8	2.62	67	7/8	1.17	30	
30382-12-12	3/4 1-1/16x12	3/4	2.72	69	1-1/8	1.27	32	

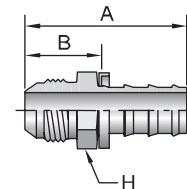

Hose
A

Fittings 82 Series
B

Equipment
C

Accessories
D

Technical
E

30682 Female JIC 37° - Swivel

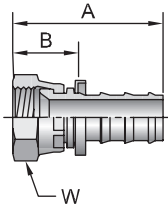

# Part Number	Thread		Hose I.D. inch	A		W inch	B		Additional Material	
	inch	mm		inch	mm		inch	mm	Brass (B)	Stainless Steel (C)
30682-4-4	1/4	7/16x20	1/4	1.52	39	9/16	0.77	20	•	•
30682-5-4	5/16	1/2x20	1/4	1.58	40	5/8	0.83	21	•	•
30682-5-6	5/8	1/2x20	3/8	1.72	44	5/8	0.82	21	•	•
30682-6-4	3/8	9/16x18	1/4	1.61	41	11/16	0.86	22	•	•
30682-6-6	3/8	9/16x18	3/8	1.75	44	11/16	0.85	22	•	•
30682-6-8	3/8	9/16x18	1/2	1.90	48	11/16	0.85	22	•	•
30682-8-6	1/2	3/4x16	3/8	1.87	47	7/8	0.97	25	•	•
30682-8-8	1/2	3/4x16	1/2	2.02	51	7/8	0.97	25	•	•
30682-10-8	5/8	7/8x14	1/2	2.14	54	1	1.09	28	•	•
30682-10-10	5/8	7/8x14	5/8	2.54	65	1	1.09	28	•	•
30682-12-12	3/4	1-1/16x12	3/4	2.65	67	1-1/4	1.20	30	•	•
30682-16-16	1	1-5/16x12	1	2.77	70	1-3/8	1.32	34	•	•

33782 Female JIC 37° - Swivel - 45° Elbow - Short Drop

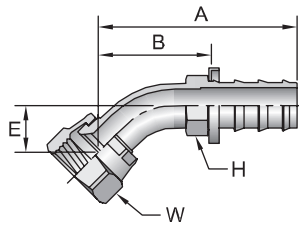

# Part Number	Thread		Hose I.D. inch	A		E		H inch	W inch	B	
	inch	mm		inch	mm	inch	mm			inch	mm
33782-4-4	1/4	7/16x20	1/4	1.74	44	0.39	10	7/16	9/16	0.99	25
33782-6-6	3/8	9/16x18	3/8	1.99	51	0.43	11	1/2	11/16	1.09	28
33782-8-8	1/2	3/4x16	1/2	2.58	66	0.55	14	5/8	7/8	1.53	39
33782-10-10	5/8	7/8x14	5/8	3.03	77	0.65	17	3/4	1	1.58	40

33982 Female JIC 37° - Swivel - 90° Elbow - Short Drop

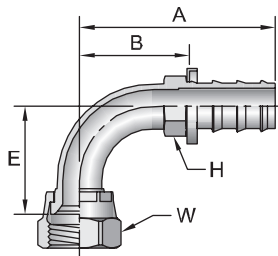

# Part Number	Thread		Hose I.D. inch	A		E		H inch	W inch	B	
	inch	mm		inch	mm	inch	mm			inch	mm
33982-4-4	1/4	7/16x20	1/4	1.55	39	0.83	21	---	9/16	0.80	20
33982-6-6	3/8	9/16x18	3/8	1.85	47	0.91	23	---	11/16	0.95	24
33982-8-8	1/2	3/4x16	1/2	2.33	59	1.09	28	5/8	7/8	1.28	33
33982-10-10	5/8	7/8x14	5/8	2.88	73	1.24	31	3/4	1	1.43	36
33982-12-12	3/4	1-1/16x12	3/4	3.26	83	1.81	46	7/8	1-1/4	1.81	46

34182 Female JIC 37° - Swivel - 90° Elbow - Long Drop

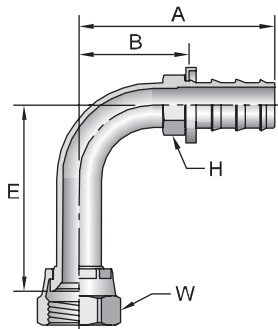

# Part Number	Thread		Hose I.D. inch	A		E		H inch	W inch	B	
	inch	mm		inch	mm	inch	mm			inch	mm
34182-4-4	1/4	7/16x20	1/4	1.79	45	1.80	46	7/16	9/16	1.04	26
34182-6-6	3/8	9/16x18	3/8	1.97	50	2.18	55	1/2	11/16	1.07	27

30482

Male SAE 45° - Rigid

# Part Number	Thread		Hose I.D. inch	A		H inch	B	
	inch	mm		inch	mm		inch	mm
30482-4-4B	1/4	7/16x20	1/4	1.51	38	7/16	0.76	19
30482-5-4B	5/16	1/2x20	1/4	1.61	41	9/16	0.86	22
30482-6-6B	3/8	5/8x18	3/8	1.84	47	5/8	0.94	24
30482-8-8B	1/2	3/4x16	1/2	2.15	55	3/4	1.10	28

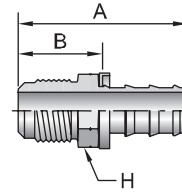

30882

Female SAE 45° - Swivel

# Part Number	Thread		Hose I.D. inch	A		W inch	B		Additional Material Brass (B)
	inch	mm		inch	mm		inch	mm	
30882-4-4	1/4	7/16x20	1/4	1.52	39	9/16	0.77	20	•
30882-5-4	5/16	1/2x20	1/4	1.58	40	5/8	0.83	21	•
30882-6-6	3/8	5/8x18	3/8	1.81	46	3/4	0.91	23	•
30882-8-6	1/2	3/4x16	3/8	1.87	47	7/8	0.97	25	•
30882-8-8	1/2	3/4x16	1/2	2.02	51	7/8	0.97	25	•
30882-10-10	5/8	7/8x14	5/8	2.54	65	1	1.09	28	•
30882-12-12	3/4	1-1/16x14	3/4	2.65	67	1-1/4	1.20	30	•

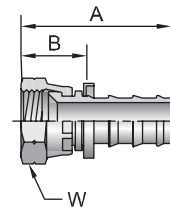

37782

Female SAE 45° - Swivel - 45° Elbow

# Part Number	Thread		Hose I.D. inch	A		E		H inch	W inch	B	
	inch	mm		inch	mm	inch	mm			inch	mm
37782-4-4	1/4	7/16x20	1/4	1.79	45	0.33	8	7/16	9/16	1.04	26
37782-6-6	3/8	5/8x18	3/8	2.08	53	0.39	10	1/2	3/4	1.18	30
37782-8-8	1/2	3/4x16	1/2	2.58	66	0.55	14	5/8	7/8	1.53	39

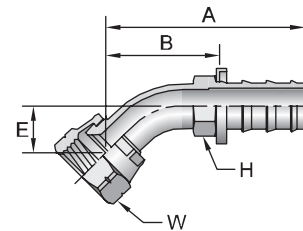

37982

Female SAE 45° - Swivel - 90° Elbow

# Part Number	Thread		Hose I.D. inch	A		E		H inch	W inch	B	
	inch	mm		inch	mm	inch	mm			inch	mm
37982-4-4	1/4	7/16x20	1/4	1.60	41	0.83	21	7/16	9/16	0.85	22
37982-6-6	3/8	5/8x18	3/8	1.98	50	0.85	22	1/2	3/4	1.08	27
37982-8-8	1/2	3/4x16	1/2	2.33	59	1.09	28	5/8	7/8	1.28	33

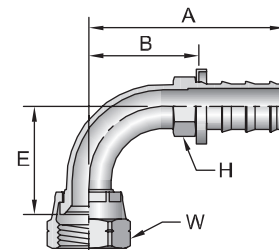

Notch in nut signifies 45° flare.

Hose
A

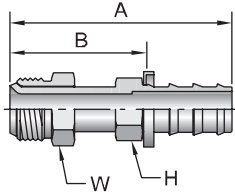

32882

Male Inverted SAE 45° - Swivel

# Part Number	Thread		Hose I.D. inch	A		H inch	W inch	B	
	inch	inch		inch	mm			inch	mm
32882-3-4	3/16	3/8x24	1/4	2.15	55	3/8	3/8	1.40	36
32882-4-4	1/4	7/16x24	1/4	2.15	55	7/16	7/16	1.40	36
32882-5-4	5/16	1/2x20	1/4	2.31	59	7/16	1/2	1.56	40
32882-6-6	3/8	5/8x18	3/8	2.58	66	1/2	5/8	1.68	43
32882-8-8	1/2	3/4x18	1/2	2.82	72	5/8	3/4	1.77	45
32882-10-10	5/8	7/8x18	5/8	3.34	85	3/4	7/8	1.89	48

Fittings 82 Series
B

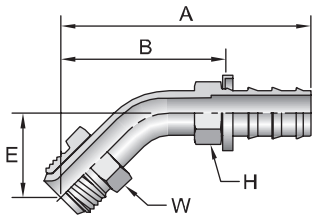

36782

Male Inverted SAE 45° - Swivel - 45° Elbow

# Part Number	Thread		Hose I.D. inch	A		E		H inch	W inch	B	
	inch	inch		inch	mm	inch	mm			inch	mm
36782-4-4	1/4	7/16x24	1/4	1.92	49	0.63	16	7/16	7/16	1.17	30
36782-6-6	3/8	5/8x18	3/8	2.64	67	0.94	24	1/2	5/8	1.74	44

Equipment
C

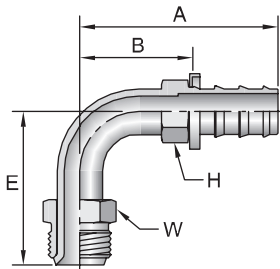

36982

Male Inverted SAE 45° - Swivel - 90° Elbow

# Part Number	Thread		Hose I.D. inch	A		E		H inch	W inch	B	
	inch	inch		inch	mm	inch	mm			inch	mm
36982-4-4	1/4	7/16x24	1/4	1.99	51	1.56	40	7/16	7/16	1.24	31
36982-5-4	5/16	1/2x20	1/4	2.17	55	1.65	42	7/16	1/2	1.42	36
36982-6-6	3/8	5/8x18	3/8	2.30	58	1.69	43	1/2	5/8	1.40	36

Accessories
D

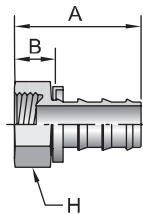

32982

Female Inverted SAE 45° - Rigid

# Part Number	Thread		Hose I.D. inch	A		H inch	B	
	inch	inch		inch	mm		inch	mm
32982-4-4B	1/4	7/16x24	1/4	1.19	30	1/2	0.44	11
32982-5-4B	5/16	1/2x20	1/4	1.25	32	9/16	0.50	13
32982-6-6B	3/8	5/8x18	3/8	1.44	37	3/4	0.54	14
32982-8-8B	1/2	3/4x18	1/2	1.62	41	7/8	0.57	14

Technical
E

3JC82

Female Seal-Lok® - Swivel - Short

ISO 12151-1 - SWSA

# Part Number	Thread		Hose I.D. inch	A		C		H		W		B	Additional Material	
	inch	mm		inch	mm	inch	mm	inch	mm	inch	mm		Brass (B)	Stainless Steel (C)
3JC82-4-4	1/4	9/16x18	1/4	1.40	36	0.32	8	9/16	11/16	0.65	17			•
3JC82-6-6	3/8	11/16x16	3/8	1.59	40	0.38	10	11/16	13/16	0.69	18			•
3JC82-6-6SM	3/8	11/16x16	3/8	1.59	40	0.38	10	19mm	22mm	0.69	18			
3JC82-8-6	1/2	13/16x16	3/8	1.65	42	0.38	10	13/16	15/16	0.76	19			
3JC82-8-8	1/2	13/16x16	1/2	1.80	46	0.43	11	13/16	15/16	0.75	19			•
3JC82-10-10	5/8	1x14	5/8	2.40	61	0.53	13	15/16	1-1/8	0.95	24			
3JC82-12-12	3/4	1-3/16x12	3/4	2.63	67	0.57	14	1-1/8	1-3/8	1.18	30			•
3JC82-16-16	1	1-7/16x12	1	2.61	66	0.58	15	1-3/8	1-5/8	1.16	29	•		•

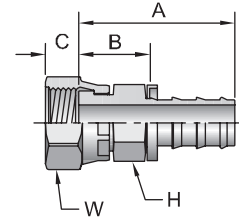

When measuring overall length to the end of the nut, B+C dimensions must be used to calculate cut-off allowance.

3J782

Female Seal-Lok® - Swivel - 45° Elbow

ISO 12151-1 - SWE45

# Part Number	Thread		Hose I.D. inch	A		E		W	B	
	inch	mm		inch	mm	inch	mm			
3J782-4-4	1/4	9/16x18	1/4	1.74	44	0.39	10	11/16	0.99	25
3J782-6-6	3/8	11/16x16	3/8	1.99	51	0.43	11	13/16	1.09	28
3J782-8-8	1/2	13/16x16	1/2	2.41	61	0.59	15	15/16	1.36	35

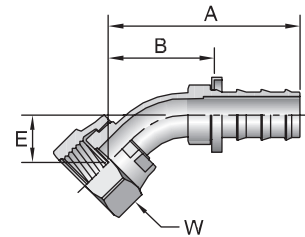

3J982

Female Seal-Lok® - Swivel - 90° Elbow - Short Drop

ISO 12151-1 - SWES90

# Part Number	Thread		Hose I.D. inch	A		E		W	B	
	inch	mm		inch	mm	inch	mm			
3J982-4-4	1/4	9/16x18	1/4	1.55	39	0.83	21	11/16	0.80	20
3J982-6-6	3/8	11/16x16	3/8	1.85	47	0.91	23	13/16	0.95	24
3J982-6-8	3/8	11/16x16	1/2	2.09	53	0.91	23	13/16	1.04	26
3J982-8-6	1/2	13/16x16	3/8	1.94	49	1.14	29	15/16	1.04	26
3J982-8-8	1/2	13/16x16	1/2	2.16	55	1.14	29	15/16	1.11	28
3J982-10-10	5/8	1x14	5/8	2.76	70	1.26	32	1-1/8	1.31	33
3J982-12-12	3/4	1-3/6x12	3/4	3.27	83	1.89	48	1-3/8	1.82	46

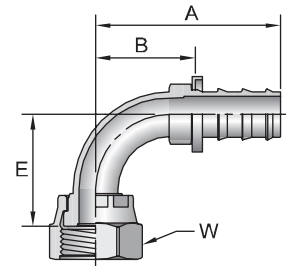

3J182

Female Seal-Lok® - Swivel - 90° Elbow - Long Drop

ISO 12151-1 - SWEL90

# Part Number	Thread		Hose I.D. inch	A		E		W	B	
	inch	mm		inch	mm	inch	mm			
3J182-6-6	3/8	11/16x16	3/8	1.85	47	2.13	54	13/16	0.95	24
3J182-8-8	1/2	13/16x16	1/2	2.16	55	2.52	64	15/16	1.11	28

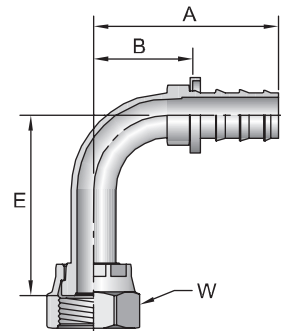

See Accessories for O-Rings.

Hose
A

Fittings 82 Series
B

Equipment
C

Accessories
D

Technical
E

Hose
A

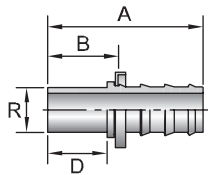

33482

Male Standpipe - Rigid - (Inch Size Tube O.D.)

# Part Number	R inch	Hose I.D. inch	A		D		B		Additional Material	
			inch	mm	inch	mm	inch	mm	Brass (B)	Stainless Steel (C)
33482-4-4	1/4	1/4	1.89	48	1.02	26	1.14	29	•	•
33482-5-4	5/16	1/4	1.93	49	1.08	27	1.18	30	•	
33482-6-6	3/8	3/8	2.23	57	1.22	31	1.33	34	•	•
33482-8-8	1/2	1/2	2.16	55	0.97	25	1.11	28	•	•
33482-10-10	5/8	5/8	2.62	67	1.00	25	1.17	30	•	
33482-12-12	3/4	3/4	2.62	67	1.00	25	1.17	30	•	•

Fittings 82 Series
B

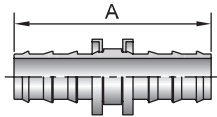

38282

Push-Lok Union

# Part Number	Hose I.D. inch	A		Additional Material Brass (B)
		inch	mm	
38282-4-4	1/4	1.80	46	•
38282-6-6	3/8	2.15	55	•
38282-8-8	1/2	2.51	64	•
38282-10-10	5/8	3.31	84	•
38282-12-12	3/4	3.31	84	•
38282-16-16	1	3.31	84	•

Equipment
C

3D082

Male Metric L - Rigid - (24° Cone)

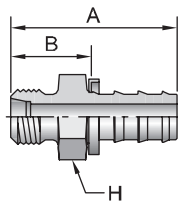

# Part Number	Thread		Hose I.D. inch	A		H mm	B	
	mm			inch	mm		inch	mm
3D082-6-4	6	M12x1,5	1/4	1.34	34	12	0.55	14
3D082-8-4	8	M14x1,5	1/4	1.38	35	14	0.59	15
3D082-10-6	10	M16x1,5	3/8	1.57	40	17	0.63	16
3D082-12-6	12	M18x1,5	3/8	1.61	41	19	0.67	17

Accessories
D

Technical
E

31D82 Male Standpipe Metric L - Rigid

# Part Number	R mm	Hose I.D. inch	A		D		B	
			inch	mm	inch	mm	inch	mm
31D82-6-4	6	1/4	1.73	44	0.87	22	0.98	25
31D82-8-4	8	1/4	1.73	44	0.87	22	0.98	25
31D82-10-6	10	3/8	1.93	49	0.91	23	1.02	26
31D82-12-6	12	3/8	1.93	49	0.91	23	1.06	27
31D82-15-8	15	1/2	2.17	55	0.98	25	1.10	28
31D82-18-10	18	5/8	2.64	67	1.02	26	1.10	28
31D82-22-12	22	3/4	2.72	69	1.10	28	1.22	31

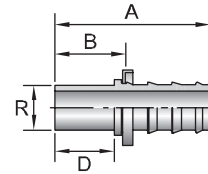

39282 Female BSP Parallel Pipe - Swivel - (60° Cone)

# Part Number	Thread inch	Hose I.D. inch	A		C		W mm	B		Additional Material Brass (B)
			inch	mm	inch	mm		inch	mm	
39282-4-4	1/4x19	1/4	1.34	34	0.22	6	17	0.55	14	
39282-6-6	3/8x19	3/8	1.50	38	0.26	7	19	0.55	14	•
39282-8-8	1/2x14	1/2	1.77	45	0.28	7	27	1.06	27	
39282-12-12	3/4x14	3/4	2.13	54	0.35	9	36	1.42	36	

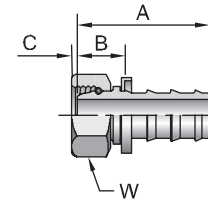

When measuring overall length to the end of the nut, B + C dimensions must be used to calculate cut-off allowances.

3D982 Male BSP Parallel Pipe - Rigid - (60° Cone)

# Part Number	Hose I.D. inch	A		H mm	B	
		inch	mm		inch	mm
3D982-2-4	1/4	1.42	36	14	0.63	16
3D982-4-4	1/4	1.61	41	19	0.83	21
3D982-4-6	3/8	1.77	45	19	0.83	21
3D982-6-6	3/8	1.77	45	22	0.87	22
3D982-8-8	1/2	2.09	53	27	0.98	25
3D982-8-10	5/8	2.44	62	27	0.94	24
3D982-12-12	3/4	2.56	65	32	1.06	27

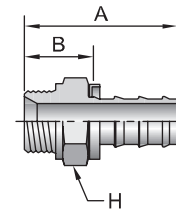

Bonded seal required if fitting is used directly in a port. See Accessories Section.

3B282 Female BSP Parallel Pipe - Swivel - 90° Elbow - (60° Cone)

# Part Number	Thread inch	Hose I.D. inch	A		E		W mm	B	
			inch	mm	inch	mm		inch	mm
3B282-4-4	1/4x19	1/4	1.65	42	1.02	26	17	1.02	26
3B282-6-6	3/8x19	3/8	2.09	53	1.18	30	19	1.18	30
3B282-8-8	1/2x14	1/2	2.56	65	1.57	40	27	1.57	40
3B282-10-10	5/8x14	5/8	2.99	76	1.57	40	30	1.57	40

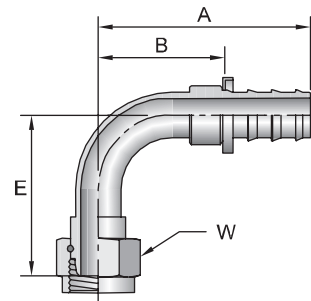

Hose
A

Fittings 82 Series
B

Equipment
C

Accessories
D

Technical
E

Hose
A

Fittings 82 Series
B

Equipment
C

Accessories
D

Technical
E

34982 DIN Metric Banjo

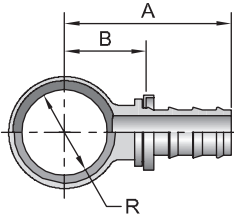

# Part Number	R		Hose I.D.		A		B	
	mm	inch	inch	mm	inch	mm		
34982-8-4	8	1/4	1.42	36	0.63	16		
34982-10-4	10	1/4	1.50	38	0.71	18		
34982-12-4	12	1/4	1.57	40	0.79	20		
34982-12-6	12	3/8	1.73	44	0.79	20		
34982-14-4	14	1/4	1.65	42	0.87	22		
34982-14-6	14	3/8	1.85	47	0.91	23		
34982-16-6	16	3/8	1.93	49	0.98	25		
34982-18-8	18	1/2	2.17	55	1.06	27		

AM Banjo Bolt with DIN Metric Thread

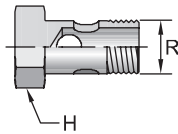

# Part Number	R Thread mm	H mm	Copper Washer (2)
AM-03	8 M8x1	12	853009-8
AM-04	10 M10x1	14	853009-10
AM-06	12 M12x1.5	17	853009-12
AM-08	14 M14x1.5	19	853009-14
AM-10	16 M16x1.5	22	853009-16
AM-13	18 M18x1.5	24	853009-18
AM-16	22 M22x1.5	27	853009-22
AM-20	26 M26x1.5	32	853009-26
AM-30	30 M30x1.5	36	853009-30

Two (2) copper washers per bolt must be ordered separately.

3CA82

Female Metric L - Swivel - (24° Cone with O-Ring)

ISO 12151-2 - SWS

# Part Number	Thread		Hose I.D. inch	A		W mm	B	
	inch	M		inch	mm		inch	mm
3CA82-8-4	8	M14x1,5	1/4	1.42	36	17	0.67	17
3CA82-10-6	10	M16x1,5	3/8	1.57	40	19	0.67	17
3A82-10-6B	10	M16x1,5	3/8	1.57	40	19	0.67	17
3A82-12-6	12	M18x1,5	3/8	1.57	40	22	0.67	17
3A82-15-8	15	M22x1,5	1/2	1.73	44	27	0.71	18
3A82-22-12	22	M30x2	3/4	2.28	58	36	0.83	21

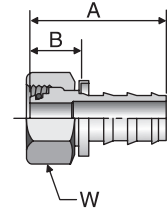

3CF82

Female Metric L - Swivel - 90° Elbow - (24° Cone with O-Ring)

ISO 12151-2 - SWE

# Part Number	Thread		Hose I.D. inch	A		E		W mm	B	
	inch	M		inch	mm	inch	mm		inch	mm
3CF82-8-4	8	M14x1,5	1/4	1.65	42	1.26	32	17	0.91	23
3CF82-10-6	10	M16x1,5	3/8	1.93	49	1.38	35	19	1.06	27
3CF82-10-6B	10	M16x1,5	3/8	1.93	49	1.38	35	19	1.06	27
3CF82-12-6	12	M18x1,5	3/8	1.93	49	1.42	36	22	1.06	27
3CF82-15-8	15	M22x1,5	1/2	2.28	58	1.61	41	27	1.26	32
3CF82-22-12	22	M30x2	3/4	3.46	88	2.17	55	36	2.01	51

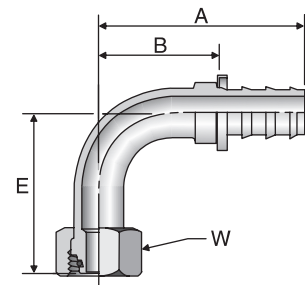

3C482

Female Metric L - Swivel - 45° Elbow - (Ball Nose)

ISO 8434-1

# Part Number	Thread		Hose I.D. inch	A		E		W mm	B	
	inch	M		inch	mm	inch	mm		inch	mm
3C482-8-4B	8	M14x1,5	1/4	2.01	51	0.63	16	17	1.26	32
3C482-10-6B	10	M16x1,5	3/8	2.28	58	0.71	18	19	1.38	35
3C482-15-8B	15	M22x1,5	1/2	2.68	68	0.75	19	27	1.61	41
3C482-22-12	22	M30x2	3/4	3.46	88	0.91	23	36	2.05	52

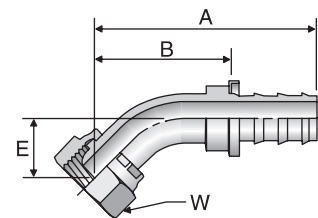

Hose
A

Fittings 82 Series
B

Equipment
C

Accessories
D

Technical
E

Hose
A

Fittings 82 Series
B

Equipment
C

Accessories
D

Technical
E

3C582

Female Metric L - Swivel - 90° Elbow - (Ball Nose)

ISO 8434-1

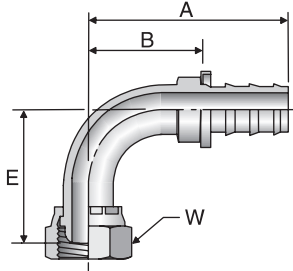

# Part Number	Thread inch	Hose I.D. inch	A		E		W mm	B	
			inch	mm	inch	mm		inch	mm
3C582-8-4B	8 M14x1,5	1/4	1.65	42	1.14	29	17	0.91	23
3C582-10-6B	10 M16x1,5	3/8	1.93	49	1.30	33	19	1.06	27
3C582-15-8B	15 M22x1,5	1/2	2.36	60	1.54	39	27	1.34	34
3C582-22-12B	22 M30x2	3/4	3.46	88	1.97	50	36	2.01	51

3C382

Female Metric L - Swivel - (Ball Nose)

ISO 8434-1

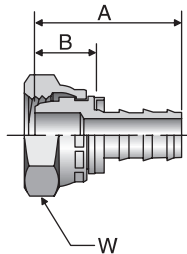

# Part Number	Thread inch	Hose I.D. inch	A		W mm	B	
			inch	mm		inch	mm
3C382-8-4B	8 M14x1,5	1/4	1.42	36	19	0.63	16
3C382-10-6B	10 M16x1,5	3/8	1.50	38	19	0.59	15
3C382-15-8B	15 M22x1,5	1/2	1.65	42	27	0.59	15
3C382-22-12B	22 M30x2	3/4	2.09	53	36	0.67	17

Parker Push-Lok® Kits

Parker Push-Lok Kits are for industrial and automotive maintenance and repair shops. They provide a low-cost inventory of Push-Lok hose and fittings packaged in a sturdy metal container. They save time and money on hose line replacements for water, air lubricating oils, anti-freeze solutions and vacuum applications.



Part No. 4-83A

Kit Contents	Quantity	Kit Contents	Quantity
Bulk Hose		Male Inverted Swivel	
831-4 (1/4" I.D.)	10 ft.	32882-3-4	1
Male Pipe		32882-4-4	4
30182-2-4B	4	32882-5-4	4
30182-4-4B	2	Female Inverted Rigid	
Female Pipe		32981-3-4B	1
30282-4-4B	2	32982-4-4B	2
Male SAE 45°		32982-5-4B	4
30482-4-4B	1	Straight Tube	
30482-5-4B	2	33482-4-4B	2
SAE (JIC) 37° Female Swivel		33482-5-4B	2
30682-4-4B	4	Hose Union	
30682-5-4B	2	38282-4-4B	2



Part No. 46-83A

Kit Contents	Quantity	Kit Contents	Quantity
Hose		Male Inverted Swivel	
831-4 (1/4" I.D.)	24 ft.	32882-3-4	3
831-6 (3/8" I.D.)	24 ft.	32882-4-4	5
Male Pipe		32882-5-4	5
30182-2-4B	8	32882-6-6	3
30182-4-4B	5	Female Inverted Rigid	
30182-4-6B	5	32982-3-4B	3
30182-6-6B	6	32982-4-4B	3
Male SAE 45°		32982-5-4B	5
30482-4-4B	2	32982-6-6B	3
30482-6-6B	3	Hose Union	
SAE (JIC) 37° Female Swivel		38282-4-4B	4
30682-6-6B	5	38282-6-6B	2
SAE 45° Swivel			
30882-4-4B	5		
30882-5-4B	5		
30882-6-6B	5		

A Hose

B Fittings 82 Series

C Equipment

D Accessories

E Technical

Parker Push-Lok® Merchandiser PLM-1 (801 Multi-Purpose Hose)

The Push-Lok® Merchandiser is an ideal method of displaying Push-Lok in will-call areas, maintenance shops, or other areas where air lines are fabricated.

Features

- PLM -1

Hose	Quantity	Size
801-4	300 Feet	1/4" I.D.
801-6	375 Feet	3/8" I.D.
801-8	100 Feet	1/2" I.D.

- 25 each of the following fittings:
 30182-4-4B 30682-4-4B 30882-6-6B
 30182-6-6B 30682-6-6B
 30182-8-8B 30682-8-8B
- Fitting drawers to store up to 18 different styles/sizes of fittings.
- TH11-1 hand held hose cutter.

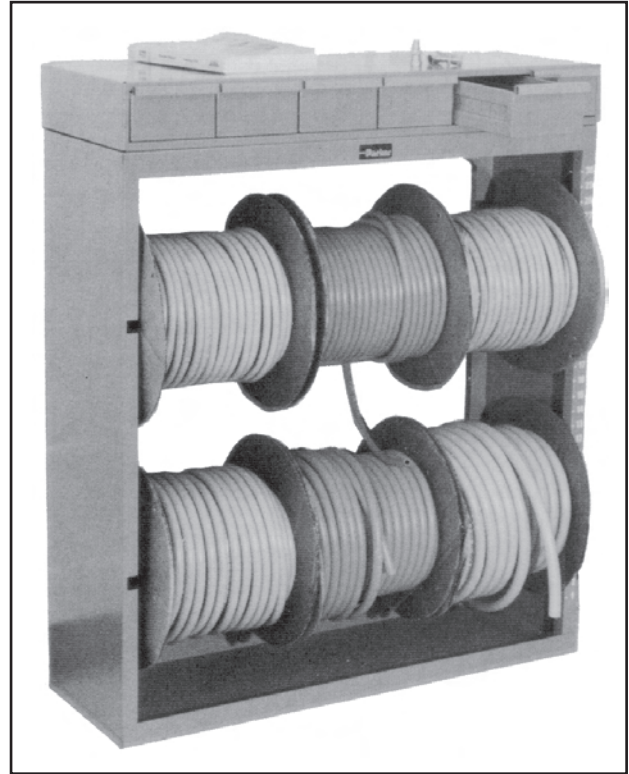

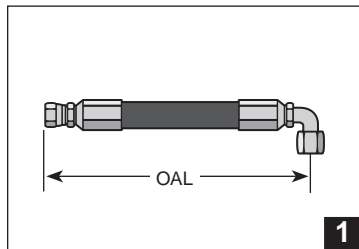

OAL : Straight to 90° Elbow

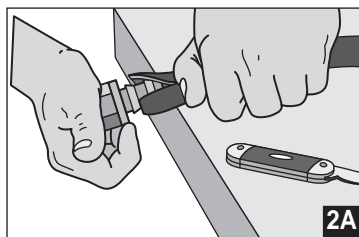
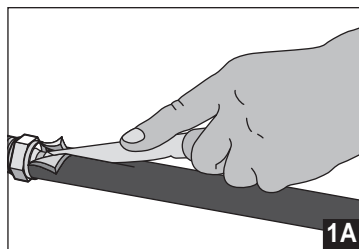
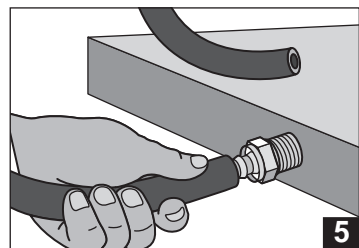

82 Series Assembly Instructions

1. Identify over all length (OAL) of hose assembly and the cut off allowance (COA) length of fitting(s) on hose ends by use of the fitting data table.
2. Properly measure and mark hose. Cut hose squarely with a Parker Push-Lok cut-off tool or a sharp knife.
3. Lubricate the Push-Lok fitting, hose I.D., or both with light oil or soapy water only - DO NOT USE HEAVY OIL OR GREASE.
4. Insert fitting into hose until first barb is in the hose.
5. Place end fitting against a flat object such as a work bench or wall. Grip hose approximately one inch from end and push with a steady force until the end of the hose is covered by the yellow plastic cap.

Disassembly Instructions

- 1A. Leave fitting in place, and cut hose approximately one inch lengthwise from the yellow plastic cap. **IMPORTANT:** Be careful not to nick barbs when cutting hose.
- 2A. Grip hose firmly and give it a sharp downward tug away from the fitting for disassembly.

Caution: Insert the Push-Lok fitting all the way into the Push-Lok hose until the cut end is concealed by the yellow plastic cap.

Caution: Sealing integrity may be damaged by use of exterior clamps.

IF YOU HAVE QUESTIONS CONCERNING THE PRODUCTS OR APPLICATION OF THE PRODUCTS CONTAINED IN THIS CATALOG, PLEASE CALL:

PARKER HOSE PRODUCTS DIVISION
 TECHNICAL SERVICES DEPARTMENT

PHONE: 440 / 943-5700

FAX: 440 / 943-3129

<http://www.parkerhose.com>

Hose
A

Fittings 82 Series
B

Equipment
C

Accessories
D

Technical
E

A Hose











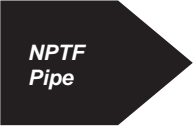
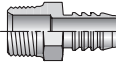
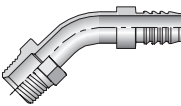
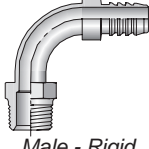



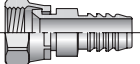
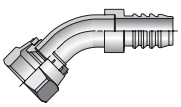
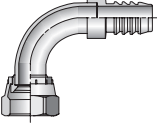

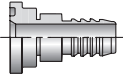

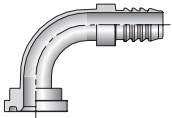

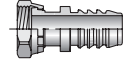
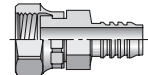
B Fittings 82 Series

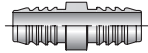
C Equipment

D Accessories

E Technical

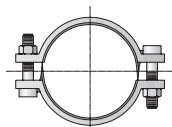

 <p>NPTF Pipe</p>	<p>0188 B-184</p>  <p>Male - Rigid</p>	<p>3188 B-184</p>  <p>Male - Rigid 45° Elbow</p>	<p>2188 B-184</p>  <p>Male - Rigid 90° Elbow</p>	 <p>Straight Thread</p>	<p>0588 B-184</p>  <p>Male - Rigid</p>
 <p>JIC 37°</p>	<p>0688 B-185</p>  <p>Female - Swivel</p>	<p>3788 B-185</p>  <p>Female - Swivel</p>	<p>3988 B-185</p>  <p>Female - Swivel</p>	 <p>Flange</p>	<p>1588 B-185</p>  <p>Flange Heads</p>
<p>1788 B-186</p>  <p>45° Elbow</p>	<p>1988 B-186</p>  <p>90° Elbow</p>	 <p>Seal-Lok® (O-Ring Face Seal)</p>	<p>JS88 B-186</p>  <p>Female - Swivel Long</p>	<p>JC88 B-186</p>  <p>Female - Swivel Short</p>	 <p>Union</p>
<p>8888 B-187</p>  <p>Union</p>	 <p>81 Series Crimp Shell</p>	<p>81 Series consists of a 10081 crimp shell and is completed by adding any 88 Series fittings.</p>	<p>10081 B-187</p>  <p>81 Series Crimp Shell</p>	 <p>Hose Clamp</p>	<p>88HC B-187</p>  <p>Hose Clamp</p>
<p>88HC-H B-187</p>  <p>Hose-Clamp</p>	<p>88DB B-187</p>  <p>Heavy Duty Clamp</p>	 <p>Assembly Instructions</p>	<p>88 Series Assembly Instructions</p>	<p>81 Series Assembly Instructions - See Section C for crimping instructions.</p>	

Hose
A

Fittings 88 Series
B

Equipment
C

Accessories
D

Technical
E

Hose
A

Fittings 88 Series
B

Equipment
C

Accessories
D

Technical
E

0188 Male NPTF Pipe - Rigid

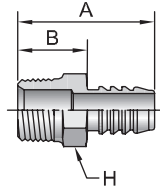

# Part Number	Thread inch	Hose I.D. inch	A		H inch	B	
			inch	mm		inch	mm
0188-12-12	3/4x14	3/4	2.25	57	1-1/8	1.13	29
0188-16-16	1x11-1/2	1	2.75	70	1-3/8	1.37	35
0188-20-20	1-1/4x11-1/2	1-1/4	3.05	77	1-3/4	1.47	37
0188-20-24	1-1/4x11-1/2	1-1/2	3.21	82	1-3/4	1.47	37
0188-24-24	1-1/2x11-1/2	1-1/2	3.24	82	2	1.50	38
0188-32-32	2x11-1/2	2	3.49	89	2-1/2	1.66	42

3188 Male NPTF Pipe - Rigid - 45° Elbow

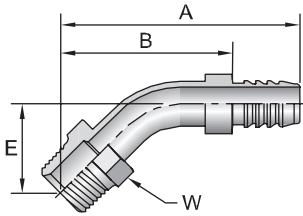

# Part Number	Thread inch	Hose I.D. inch	A		E		W inch	B	
			inch	mm	inch	mm		inch	mm
3188-16-16	1x11-1/2	1	4.12	105	1.63	41	1-3/8	2.74	70
3188-20-20	1-1/4x11-1/2	1-1/4	4.54	115	1.77	45	1-3/4	2.96	75

2188 Male NPTF Pipe - Rigid - 90° Elbow

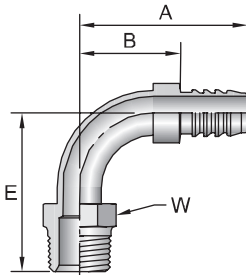

# Part Number	Thread inch	Hose I.D. inch	A		E		W inch	B	
			inch	mm	inch	mm		inch	mm
2188-12-12	3/4x14	3/4	2.83	72	2.67	68	1-1/8	1.70	43
2188-16-16	1x11-1/2	1	3.35	85	3.18	81	1-3/8	1.97	50
2188-20-20	1-1/4x11-1/2	1-1/4	3.80	97	3.41	87	1-3/4	2.21	56
2188-24-24	1-1/2x11-1/2	1-1/2	4.20	107	3.61	92	2	2.46	62
2188-32-32	2x11-1/2	2	4.86	123	4.23	107	2-1/2	3.03	77

0588 Male SAE Straight Thread with O-Ring - Rigid

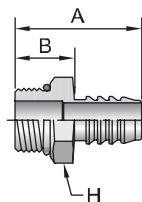

# Part Number	Thread inch	Hose I.D. inch	A		H inch	B	
			inch	mm		inch	mm
0588-12-12	1-1/16x12	3/4	2.13	54	1-1/4	1	25
0588-16-16	1-5/16x12	1	2.38	60	1-1/2	1	25
0588-20-20	1-5/8x12	1-1/4	2.59	66	1-7/8	1	25

See page B-187 for 81 Series crimp shells and clamps for 88 Series fittings.
See Equipment Section for assembly and crimping instructions.
See Section D for Flange Kits and O-Rings.

0688

Female JIC 37° - Swivel

# Part Number	Thread		Hose I.D. inch	A		W inch	B	
	inch	1-1/16x12		inch	mm		inch	mm
0688-12-12	3/4	1-1/16x12	3/4	2.66	68	1-1/4	1.53	39
0688-16-12	1	1-5/16x12	3/4	1.86	47	1-1/2	1.38	35
0688-16-16	1	1-5/16x12	1	2.72	69	1-1/2	1.34	34
0688-20-20	1-1/4	1-5/8x12	1-1/4	3.34	85	2	1.75	44
0688-24-24	1-1/2	1-7/8x12	1-1/2	3.67	93	2-1/4	1.93	49
0688-32-32	2	2-1/2x12	2	4.14	105	2-7/8	2.31	59

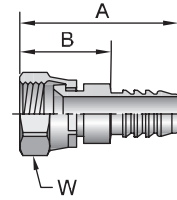

3788

Female JIC 37° - Swivel

# Part Number	Thread		Hose I.D. inch	A		W inch	B	
	inch	1-1/16x12		inch	mm		inch	mm
3788-12-12	3/4	1-1/16x12	3/4	3.07	78	1-1/4	1.94	49
3788-16-16	1	1-5/16x12	1	3.51	89	1-1/2	2.13	54
3788-20-20	1-1/4	1-5/8x12	1-1/4	3.97	101	2	2.38	60

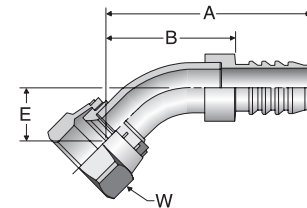

3988

Female JIC 37° - Swivel

# Part Number	Thread		Hose I.D. inch	A		W inch	B	
	inch	1-1/16x12		inch	mm		inch	mm
3988-12-12	3/4	1-1/16x12	3/4	2.98	76	1-1/4	1.85	47
3988-16-16	1	1-5/16x12	1	3.48	88	1-1/2	2.10	53
3988-20-20	1-1/4	1-5/8x12	1-1/4	3.81	97	2	2.22	56
3988-24-24	1-1/2	1-7/8x12	1-1/2	4.21	107	2-1/4	2.47	63

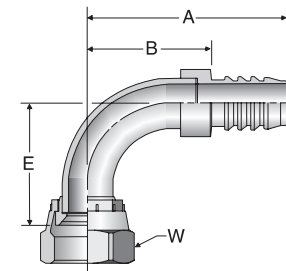

1588

SAE Code 61 Flange Head

ISO 12151-3 - S - L

# Part Number	Flange inch	Hose I.D. inch	A		F inch	B	
			inch	mm		inch	mm
1588-16-16	1	1	2.57	65	1-3/4	1.19	30
1588-20-20	1-1/4	1-1/4	3.37	86	2	1.78	4
1588-24-24	1-1/2	1-1/2	3.78	96	2-3/8	2.04	52
1588-32-32	2	2	4.32	110	2-13/16	2.49	63

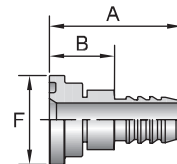

See page B-187 for 81 Series crimp shells and clamps for 88 Series fittings.
See Equipment Section for assembly and crimping instructions.
See Accessories Section for Flange Kits and O-Rings.

Hose
A

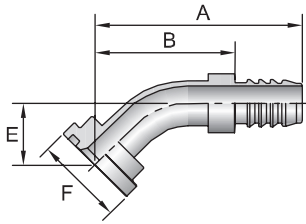

1788

SAE Code 61 Flange Head - 45° Elbow

ISO 12151-3 - E45S - L (1 Piece: ISO 12151-3 - E45M - L)

#			A		E			B	
Part Number	Flange inch	Hose I.D. inch	inch	mm	inch	mm	inch	inch	mm
1788-16-16	1	1	3.55	90	1.06	27	1-3/4	2.17	55
1788-20-20	1-1/4	1-1/4	3.90	99	1.13	29	2	2.31	59
1788-24-24	1-1/2	1-1/2	4.15	105	1.11	28	2-3/8	2.41	61
1788-32-32	2	2	4.58	116	1.25	32	2-13/16	2.75	70

Fittings 88 Series
B

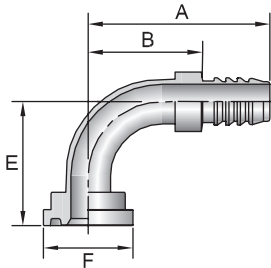

1988

SAE Code 61 Flange Head - 90° Elbow

ISO 12151-3 - E90S - L (1 Piece: ISO 12151-3 - E90M - L)

#			A		E			B	
Part Number	Flange inch	Hose I.D. inch	inch	mm	inch	mm	inch	inch	mm
1988-16-16	1	1	3.35	85	2.37	60	1-3/4	1.97	50
1988-20-20	1-1/4	1-1/4	3.80	97	2.50	64	2	2.21	56
1988-24-24	1-1/2	1-1/2	4.20	107	2.74	70	2-3/8	2.46	62
1988-32-32	2	2	4.86	123	3.19	81	2-13/16	3.03	77

Equipment
C

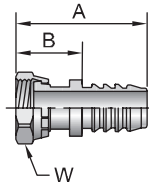

JS88

Female Seal-Lok® - Swivel - Long

ISO - 12151-1 - SWSB

#			A			B		
Part Number	Thread inch	Hose I.D. inch	inch	mm	inch	inch	mm	
JS88-20-20	1-1/4	1-11/16x12	1-1/4	3.21	82	1-7/8	1.15	29
JS88-24-24	1-1/2	2x12	1-1/2	3.47	88	2-1/4	1.73	44

Accessories
D

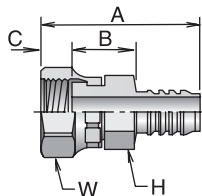

JC88

Female Seal-Lok - Swivel - Short

ISO 12151-1 - SWSA

#			A		C			B		
Part Number	Thread inch	Hose I.D. inch	inch	mm	inch	inch	inch	inch	mm	
JC88-12-12	3/4	1-3/16x12	3/4	2.80	71	0.57	1-1/8	1-3/8	1.70	43
JC88-16-12	1	1-7/16x12	3/4	2.82	72	0.58	1-3/8	1-5/8	1.69	43
JC88-16-16	1	1-7/16x12	1	3.07	78	0.59	1-3/8	1-5/8	1.69	43
JC88-20-16	1-1/4	1-11/16x12	1	3.08	78	0.59	1-7/8	1-5/8	1.70	43
JC88-20-20	1-1/4	1-11/16x12	1-1/4	3.29	84	0.59	1-7/8	1-7/8	1.70	43

When measuring overall length to the end of the nut, B+C dimensions must be used to calculate cut-off allowance.

See page B-187 for 81 Series crimp shells and clamps for 88 Series fittings.
See Equipment Section for assembly and crimping instructions.
See Accessories Section for Flange Kits and O-Rings.

Technical
E

8888
Union (Hose Splicer)

# Part Number	Hose I.D. inch	A	
		inch	mm
8888-12-12	3/4	2.70	67
8888-16-16	1	3.21	82
8888-20-20	1-1/4	3.61	92
8888-24-24	1-1/2	3.92	100
8888-32-32	2	4.04	103

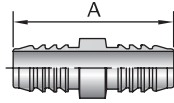

88HC
Hose Clamp (Worm Gear)

# Part Number	Hose I.D. inch
88HC-12	3/4
88HC-16	1
88HC-20	1-1/4
88HC-24	1-1/2
88HC-32	2



10081
Crimp Shell

# Part Number	Hose I.D. inch
10081-12	3/4
10081-16	1
10081-20	1-1/4
10081-24	1-1/2
10081-32	2



81 Series consists of a 10081 crimp shell and is completed by adding any 88 Series Fittings. See Equipment Section for complete 81 Series Assembly and Crimping instructions.

88HC-H
Hose Clamp
(High Torque Worm Gear)

# Part Number	Hose I.D. inch
88HC-12H	3/4
88HC-16H	1
88HC-20H	1-1/4
88HC-24H	1-1/2
88HC-32H	2



88DB
Heavy Hose Clamp
(Double Bolt)

# Part Number	Hose I.D. inch
88DB-12	3/4
88DB-16	1
88DB-20	1-1/4
88DB-24	1-1/2
88DB-32	2

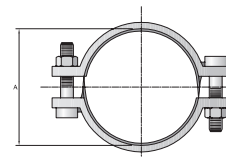

Hose
A

Fittings 88 Series
B

Equipment
C

Accessories
D

Technical
E

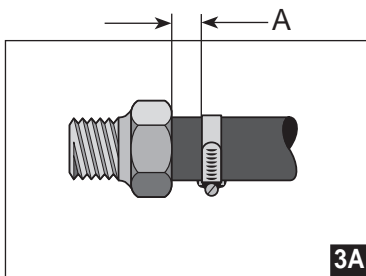
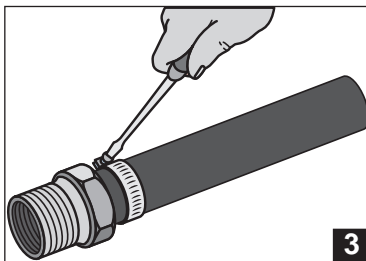
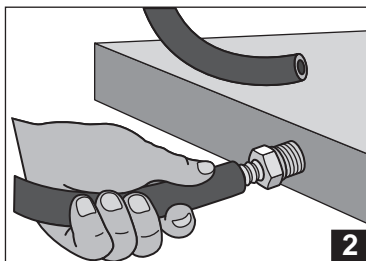
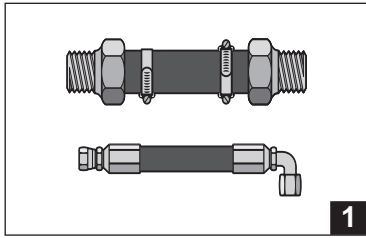

88 Series

Hose Assembly Instructions





1. Identify Over All Length (OAL) of hose assembly and the Cut Off Allowance (COA) length of fitting(s) by use of the fitting data table. Properly measure and mark hose. Cut hose cleanly and squarely to length. Trim any exposed wire reinforcement to prevent injury in service.
 2. Slide clamp(s) onto hose and lubricate hose. Push hose onto fitting until hose bottoms against stop ring or hex.
 3. Position hose clamp(s) as shown and secure with a screwdriver or wrench. Maintain "A" dimensions as shown below for proper clamp positioning of both HC clamps and HC-H clamps.
- 3A. Evenly attach double bolt clamps for maximum grip.

Hose I.D. inch	A	
	inch	mm
-12	1/4	6.35
-16	3/8	9.53
-20	3/8	9.53
-24	1/2	12.70
-32	1/2	12.70

Note: For permanent installation of 88 Series Fittings, an 81 Series Crimp Shell must be added. See Equipment Section for assembly and crimping instructions.

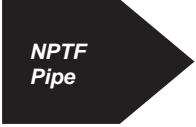
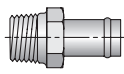
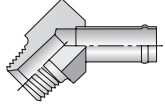
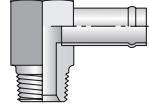
IF YOU HAVE QUESTIONS CONCERNING THE PRODUCTS OR APPLICATION OF THE PRODUCTS CONTAINED IN THIS CATALOG, PLEASE CALL:

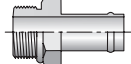
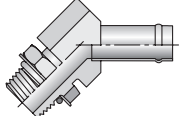
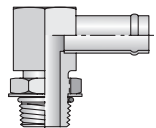
PARKER HOSE PRODUCTS DIVISION
TECHNICAL SERVICES DEPARTMENT
PHONE: 440-943-5700
FAX: 440-943-3129
<http://www.parkerhose.com>

 <p>NPTF Pipe</p>	<p>01TB B-190</p>  <p><i>Male - Rigid</i></p>	<p>31TB B-190</p>  <p><i>Male - Rigid 45° Elbow</i></p>	<p>21TB B-190</p>  <p><i>Male - Rigid 90° Elbow</i></p>	 <p>SAE Straight Thread</p>	<p>05TB B-191</p>  <p><i>Male - Rigid</i></p>
<p>35TB B-191</p>  <p><i>Male - Rigid 45° Elbow</i></p>	<p>25TB B-191</p>  <p><i>Male - Rigid 90° Elbow</i></p>	 <p>Clamp</p>	<p>Clamp B-187</p>  <p><i>Wormgear</i></p>		

Hose
A

Fittings TB Series
B

Equipment
C

Accessories
D

Technical
E

Hose
A

Fittings TB Series
B

Equipment
C

Accessories
D

Technical
E

01TB Male NPTF Pipe - Rigid

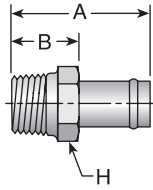

# Part Number	Thread inch	Hose I.D. inch	A		H		B	
			inch	mm	inch	inch	mm	
01TB-4-6	1/4x18	3/8	2.09	53	5/8	0.96	24	
01TB-6-8	3/8x18	1/2	2.12	54	3/4	0.96	24	
01TB-8-10	1/2x14	5/8	2.31	59	7/8	1.15	29	
01TB-8-12	1/2x14	3/4	2.31	59	1	1.15	29	
01TB-12-12	3/4x14	3/4	2.13	54	1-1/8	0.97	24	
01TB-16-16	1x11-1/2	1	2.69	68	1-3/8	1.53	39	
01TB-20-20	1-1/4x11-1/2	1-1/4	2.84	72	1-3/4	1.34	34	
01TB-24-24	1-1/2x11-1/2	1-1/2	3.25	83	2	1.50	38	
01TB-32-32	2x11-1/2	2	3.53	90	2-5/8	1.78	45	

31TB Male NPTF Pipe - Rigid - 45° Elbow

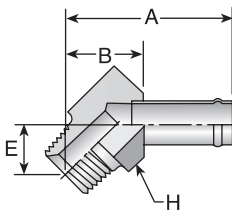

# Part Number	Thread inch	Hose I.D. inch	A		E		H		B	
			inch	mm	inch	mm	inch	inch	mm	
31TB-6-8	3/8x18	1/2	2.54	65	0.69	18	7/8	1.04	26	
31TB-8-10	1/2x14	5/8	2.68	68	0.82	21	1	1.18	30	
31TB-8-12	1/2x14	3/4	2.78	71	0.82	21	1-1/4	1.28	33	
31TB-12-12	3/4x14	3/4	2.82	72	0.86	22	1-1/4	1.32	34	
31TB-12-16	3/4x14	1	3.01	76	0.86	22	1-1/2	1.38	35	
31TB-16-16	1x11-1/2	1	3.19	81	1.04	26	1-1/2	1.56	40	
31TB-20-20	1-1/4x11-1/2	1-1/4	3.26	83	0.99	25	1-7/8	1.59	40	

21TB Male NPTF Pipe - Rigid - 90° Elbow

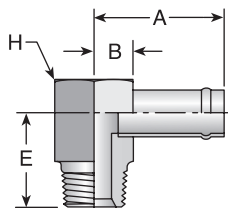

# Part Number	Thread inch	Hose I.D. inch	A		E		H		B	
			inch	mm	inch	mm	inch	inch	mm	
21TB-6-8	3/8x18	1/2	1.94	49	1.22	31	7/8	0.44	11	
21TB-8-10	1/2x14	5/8	2.03	52	1.47	37	1-1/16	0.53	13	
21TB-8-12	1/2x14	3/4	2.16	55	1.59	40	1-5/16	0.66	17	
21TB-12-12	3/4x14	3/4	2.16	55	1.59	40	1-5/16	0.66	17	
21TB-12-16	3/4x14	1	2.44	62	1.59	40	1-5/8	0.81	21	
21TB-16-14	1x11-1/2	7/8	2.31	59	1.97	50	1-5/8	0.81	21	
21TB-16-16	1x11-1/2	1	2.44	62	1.97	50	1-5/8	0.81	21	

05TB

Male SAE Straight Thread with O-Ring - Rigid

# Part Number	Thread		Hose I.D.		A		H		B	
	inch	mm	inch	mm	inch	mm	inch	mm	inch	mm
05TB-6-6	9/16x18		3/8	1.94	49	11/16	0.69	18		
05TB-8-8	3/4x16		1/2	2.00	51	7/8	0.75	19		
05TB-8-10	3/4x16		5/8	2.00	51	7/8	0.75	19		
05TB-10-10	7/8x14		5/8	2.06	52	1	0.81	21		
05TB-12-12	1-1/16x12		3/4	2.25	57	1-1/4	1.00	25		
05TB-16-16	1-5/16x12		1	2.38	60	1-1/2	1.00	25		
05TB-20-20	1-5/8x12		1-1/4	2.50	64	1-7/8	1.00	25		

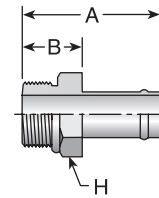

35TB

Male SAE Straight Thread with O-Ring - Rigid - 45° Elbow

# Part Number	Thread		Hose I.D.		A		E		H		W		B	
	inch	mm	inch	mm	inch	mm	inch	mm	inch	mm	inch	mm	inch	mm
35TB-8-8	1/2	3/4x16	1/2	2.79	71	0.93	24	7/8	7/8	1.29	33			
35TB-10-10	5/8	7/8x14	5/8	2.80	71	0.93	24	1	1	1.28	33			
35TB-12-12	3/4	1-1/16x12	3/4	3.18	81	1.22	31	1-1/4	1-1/4	1.68	43			
35TB-16-16	1	1-5/16x12	1	3.45	88	1.30	33	1-1/2	1-1/2	1.82	46			
35TB-20-16	1-1/4	1-5/8x12	1	3.57	91	1.34	34	1-7/8	1-7/8	1.94	49			

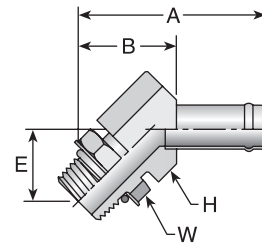

25TB

Male SAE Straight Thread with O-Ring - Rigid - 90° Elbow

# Part Number	Thread		Hose I.D.		A		E		H		W		B	
	inch	mm	inch	mm	inch	mm	inch	mm	inch	mm	inch	mm	inch	mm
25TB-8-6	1/2	3/4x16	3/8	1.94	49	1.45	37	7/8	7/8	0.44	11			
25TB-8-8	1/2	3/4x16	1/2	1.94	49	1.44	37	7/8	7/8	0.44	11			
25TB-10-10	5/8	7/8x14	5/8	2.03	52	1.69	43	1-1/16	1	0.53	13			
25TB-10-12	5/8	7/8x14	3/4	2.16	55	1.69	43	1-5/16	1	0.66	17			
25TB-12-12	3/4	1-1/16x12	3/4	2.16	55	1.92	49	1-5/16	1-1/4	0.66	17			
25TB-16-12	1	1-5/16x12	3/4	2.31	59	2.03	52	1-5/8	1-1/2	0.81	21			
25TB-16-16	1	1-5/16x12	1	2.44	62	2.03	52	1-5/8	1-1/2	0.81	21			
25TB-20-16	1-1/4	1-5/8x12	1	2.57	65	2.34	59	1-7/8	1-7/8	0.94	24			
25TB-20-20	1-1/4	1-5/8x12	1-1/4	2.61	66	2.34	59	1-7/8	1-7/8	0.94	24			

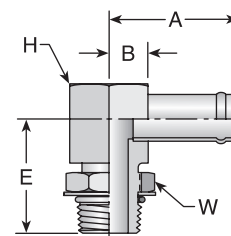

Hose
A

Fittings TB Series
B

Equipment
C

Accessories
D

Technical
E

Hose
A

Fittings TB Series
B

Equipment
C

Accessories
D

Technical
E

