

ENGINEERING
TOMORROW



Technical Information

DGM-3 40/41 Design**

ISO4401 Size 03;
ANSI/B93.7M-D03



SystemStak™ Valves

ISO 4401 Size 03



Build a Compact, Cost-Effective, Reliable Hydraulic System with Danfoss SystemStak™ Valves

Reduces System Space Requirements

SystemStak valves make compact hydraulic systems in which specific function valves are “sandwich’ mounted between a directional valve and a standard mounting surface.

Reduce Cost

SystemStak valves eliminate intervalve piping and leak-prone tube and pipe connections. Installed cost is less than when using conventional valves.

Versatile and Easy to Install

SystemStak valves have all the internal passages necessary to serve the directional valve topping them. Mounting surfaces and port patterns are to international standards: any valve conforming to ISO 4401 size 03; ANSI/B93.7M size D03; NFPA-D03; CETOP 3; and DIN 24340, NG6 mounting interface can be used with these SystemStak valves.

Rugged and Reliable

Internal working parts are produced from hardened steel and mounted in ductile (spheroidal graphite) iron bodies. Excellent reliability is ensured. Working parts are accessible without removing valves from an assembled stack.

SystemStak Systems... Easy to Understand, Easy to Design

SystemStak circuitry is best shown using slightly different symbols than those for traditional valve configurations. Each SystemStak symbol has the same basic form and size as shown in fig. 1.

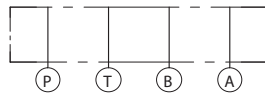

Figure 1

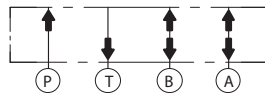

Figure 2

For ease of understanding, remember the directions of flow for each line, and that all four flow paths pass through each valve (see fig. 2). For clarity, directional

valves are drawn vertically in SystemStak circuit diagrams (see fig. 3).

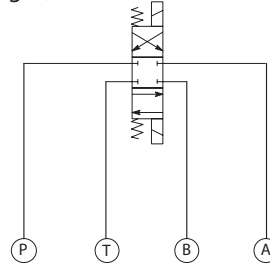

Figure 3

Each station (valve stack) is a combination of functions. When designing and assembling SystemStak valves, care must be taken to ensure that they interact as required by stacking the functions in the correct sequence (fig. 4 is an example).

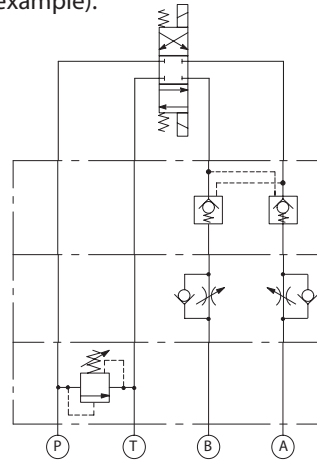

Figure 4

Relief valves should normally be positioned next to the mounting surface (i.e. at the bottom of the stack). When both a flow control and a pilot operated check valve are required, it is recommended that the flow control valve be between the check valve and the actuator to prevent check valve chatter.

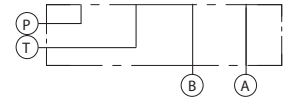

Figure 5

A combination of directional valve, SystemStak valve(s) and subplate/manifold block (fig. 5: single station subplate and fig. 6: multi-station manifold) completes the assembly.

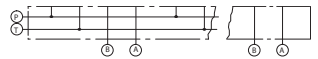

Figure 6

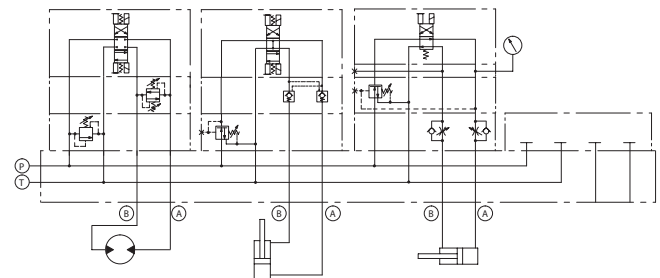

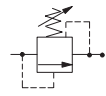
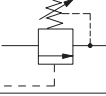
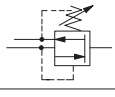
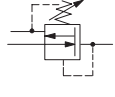

Figure 7

Fig. 7 represents a complete SystemStak system, showing typical use of functions available from this range. The circuit diagram also shows the use of a

tapping plate for accessing line pressure readings, and a blanking plate to close off an unused station of a multi-station manifold.

Table of Contents

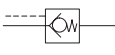
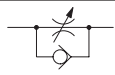

Function	Basic symbol	Basic model	Features	Page
Relief		DGMC	Single, dual and crossport models	5
Counterbalance		DGMR	Control in port T	8
Sequence		DGMR1	Single port P sequence	8
Reducing/relieving		DGMX	Piloted from (and reduced pressure in) port P, A or B	8
Direct check		DGMDC	Single check in any port; dual check in ports A and B only	11
Pilot operated check		DGMPC	Single in port A or B; dual in ports A and B	14
Flow restrictor		DGMFN	Single or dual port, meter-in or meter-out	17
Further information: Mounting bolts, subplates and manifold blocks Hydraulic fluids Filtration requirements Temperature limits Pressure drop at other viscosities Types H and K adjusters Warranty and repair Ordering procedure				20

DGMC-3-41
DGMC2-3-41

General Description

These two-stage adjustable pressure relief valves limit the maximum pressure in the line(s) controlled by the integral relief valve elements.

Pressure adjustment options of control knob (with or without keylock) or screw/locknut design are available. The two-stage operation is basically identical to long-established balanced piston valves, described in detail in Danfoss Industrial hydraulics manual.

Typical Section

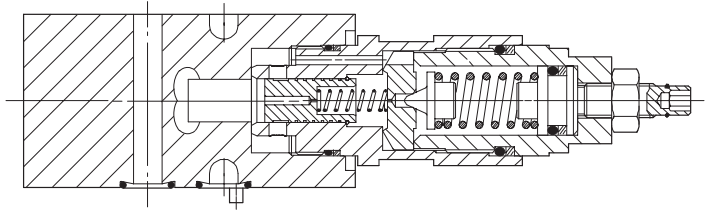

Model Codes

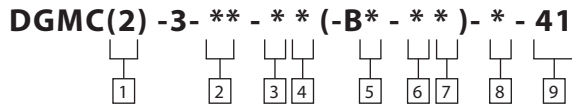

1 Type
2 – Dual relief function
Omit for single relief function

2 First function
Single relief, or first line of dual models

Code	Pressure limited in	Discharge into	Usage
PT	P	T	Single only
AB	A	B	Single, or dual with BA
BA	B	A	Single only
AT	A	T	Single, or dual with BT
BT	B	T	Single only

3 Pressure adjustment range, first function
A – 3-50 bar (45-725 psi)
B – 3-100 bar (45-1450 psi)
C – 10-200 bar (145-2900 psi)
G – 50-315 bar (725-4500 psi)

4 Pressure adjustment/locking method, first function
H – Handknob
K – Micrometer with keylock
W – Screw and locknut

5 Second function
Second line of dual models

Code	Pressure limited in	Discharge into	Usage
BA	B	A	Dual with AB
BT	B	T	Dual with AT

Omit for single line models

6 Pressure adjustment range, second function
Options as in **3**

7 Pressure adjustment/locking method, second function
Options as in **4**

8 Gauge port: option on AT and PT single models only
B – G1/4" 1/4 BSPF
S – SAE 4 (7/16"-20 UNF-2B)
Blank – No gauge

9 Design number, 41 series
Subject to change. Installation dimensions unchanged for design numbers 40 to 49 inclusive.

Functional Symbols



For simplicity these two-stage valves are represented as single-stage models

DGMC-3-PT-41

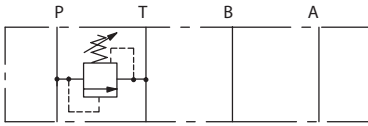

DGMC2-3-AT-**-BT-41

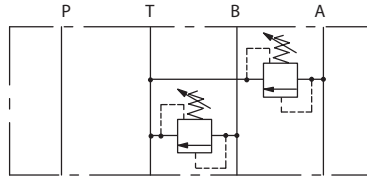

DGMC-3-BA-41

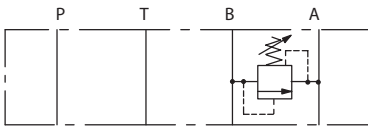

DGMC2-3-AB-**-BA-41

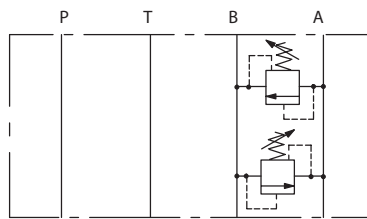

Operating Data

Maximum flow rate	60 L/min (16 USgpm)
Maximum operating pressure	315 bar (4500 psi)
Pressure drops	See graphs
Mounting position	Optional
Mass Approx.	DGMC- 1.3kg (2.9lb) DGMC2- 2.5kg (5.5lb)

Performance Data

Pressure override Typical performance for PT models at max. pressure settings with mineral oil at 21 cSt (102 SUS) and at 50°C (122 °F).

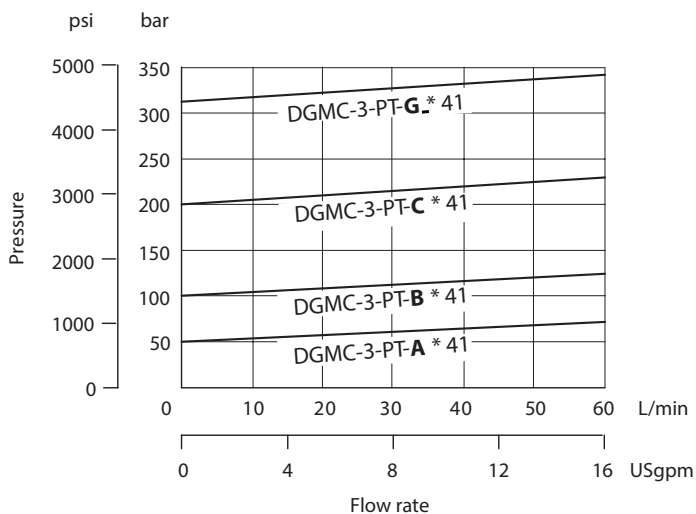

Installation Dimensions

in mm (inches)



DGMC(2)-3**-**(-B*-**-41

Models with type W adjuster

To adjust valve setting
slacken off locknut and turn
adjuster screw. ■

■ Turn clockwise to increase
pressure; counter-clockwise
to decrease pressure
Re-tighten locknut after
completing adjustment.

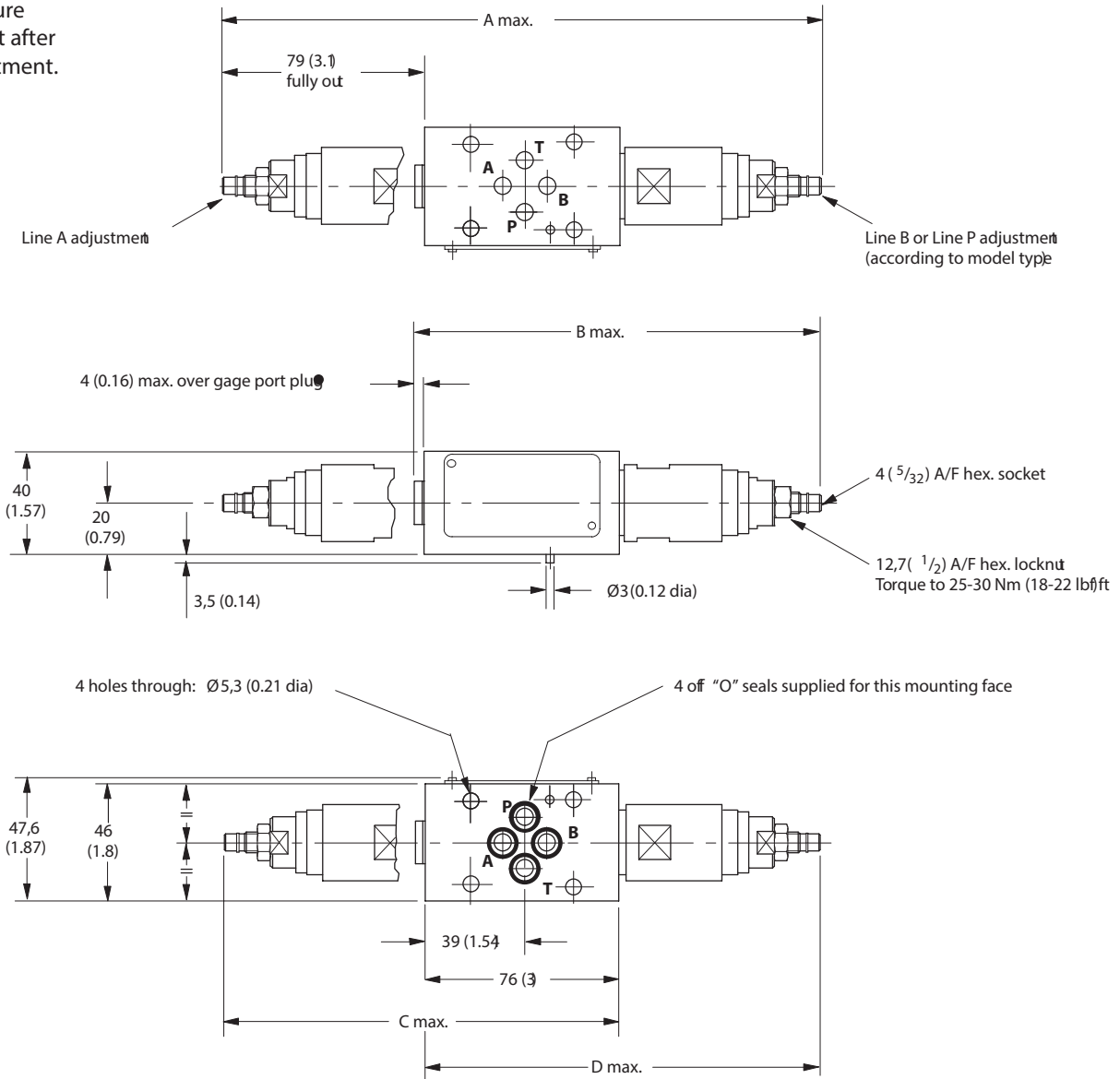
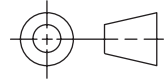

Model	A	B	C	D
DGMC-3-AT-*W-41	-	-	154 (6.1)	-
DGMC-3-BT-*W-41	-	-	-	156 (6.2)
DGMC-3-AT-*W-*-41	-	160 (6.3)	-	-
DGMC-3-PT-*W-41	-	-	-	156 (6.2)
DGMC-3-PT-*W-*-41	-	160 (6.3)	-	-
DGMC2-3-AT-*W-BT-*W-41	234 (9.2)	-	-	-

● For gage port thread options see model code

Installation Dimensions

in mm (inches)

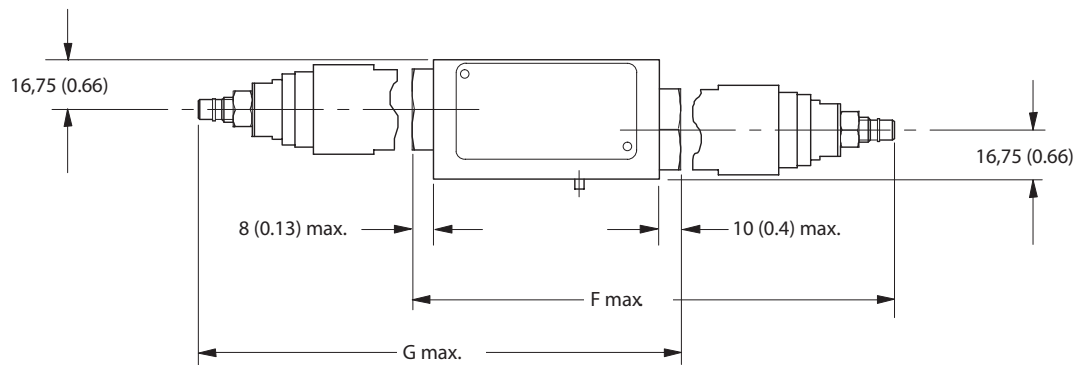
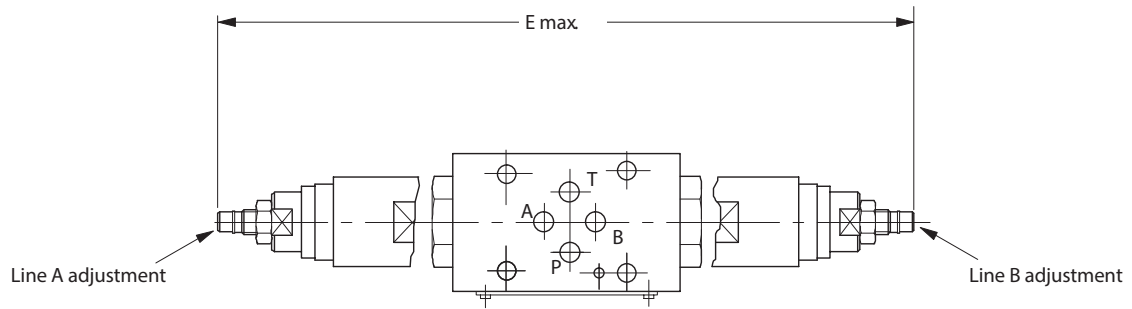

Model	E	F	G
DGMC-3-AB-*W-41	-	-	164 (6.5)
DGMC-3-BA-*W-*-41	-	164 (6.5)	-
DGMC2-3-AB-*W-BA-*W-41	234 (9.2)	-	-

DGMR(1)-3-40
DGMX*-3-40

General Description

These single-stage valves operate by the application of pressure on the end of the valve spool, acting against a spring which is loaded by means of the adjustment mechanism.

In the counterbalance and sequence valves the spool is offset by the spring such that flow cannot pass through the valve. When the force exerted by the pilot pressure on the spool end exceeds the force of the main spring, the spool is moved to allow flow through the valve.

In the pressure reducing valve the flow path is normally open and is closed as the pilot pressure exceeds the setting of the valve. Excessive pressure in the reduced-pressure line is prevented by a pressure relieving function.

Pressure adjustment options of control knob (with or without keylock) or screw/locknut design are available.

Typical Section

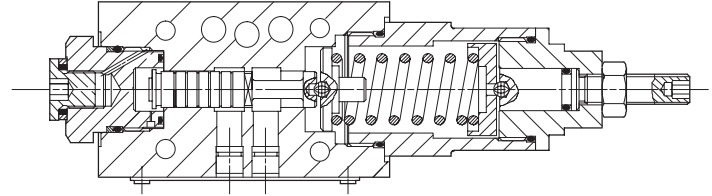

Model Code

DGM *(*) -3- ** (*) - * * - * - 40

┌
└
1

┌
└
2

┌
└
3

┌
└
4

┌
└
5

┌
└
6

┌
└
7

1 Type

- R** – Counterbalance function
- R1** – Sequence function
- X1** – Pressure reducing, underlapped
- X2** – Pressure reducing, overlapped
- X3** – Pressure reducing, overlapped, low leakage

2 Function ports

- For DGMR only:**
- TA** – Counterbalance control function in “T” port, controlled by pressure in “A” port
- For DGMR1 only:**
- PP** – Sequence control in “P” port, controlled by

- pressure in “P” port
- For DGMX only:**
- PA** – Pressure reducing function in line P, piloted from A
 - PB** – Pressure reducing function in line P, piloted from B
 - PP** – Pressure reducing function in line P, piloted from P

3 Adjuster location

- Option on DGMX only
- L** – Adjuster at “A”-port end of valve
 - Blank** – Adjuster at “B”-port end of valve

4 Pressure adjustment range

- For DGMX only:**
- Y** – 1,40-7,0 bar (21-101 psi)
 - R** – 1,40-45,0 bar (21-652 psi)
- For DGMR and DGMX:**
- A** – 3-30 bar (43.5-435 psi)
 - B** – 3,5-70 bar (51-1000 psi)
 - C** – 10-140 bar (145-2000 psi)
 - F** – 20-250 bar (290-3625 psi)

5 Pressure adjustment/locking method

- H** – Handknob
- K** – Micrometer with keylock
- W** – Screw and locknut

6 Gauge port

- B** – G1/8” (1/8 BSPF)
- S** – SAE 4(7/16”-20 UNF-2B)

7 Design number, 40 series

Subject to change.
Installation dimensions unchanged for design numbers 40 to 49 inclusive.

DGMR-3-TA

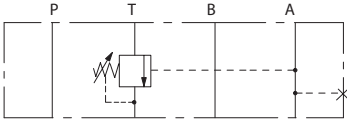

DGMX*-3-PB

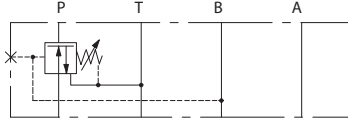

DGMX*-3-PA

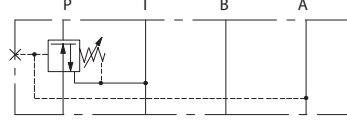

DGMR1-3-PP

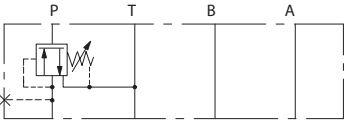

DGMX*-3-PP

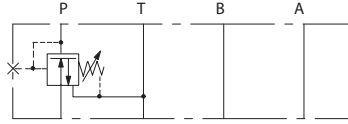

Operating Data

Maximum flow rate	60 L/min (16 USgpm)
Maximum operating pressure	315 bar (4500 psi)
Pressure drops	See graphs
Mounting position	Optional
Mass Approx.	DGMR*- 1.3kg (2.9lb) DGMX*- 1.3kg (2.9lb)

Performance Data

Typical performance with mineral oil at 21 cSt (102 SUS) and at 50 °C (122 °F).

DGMX*-3-P*

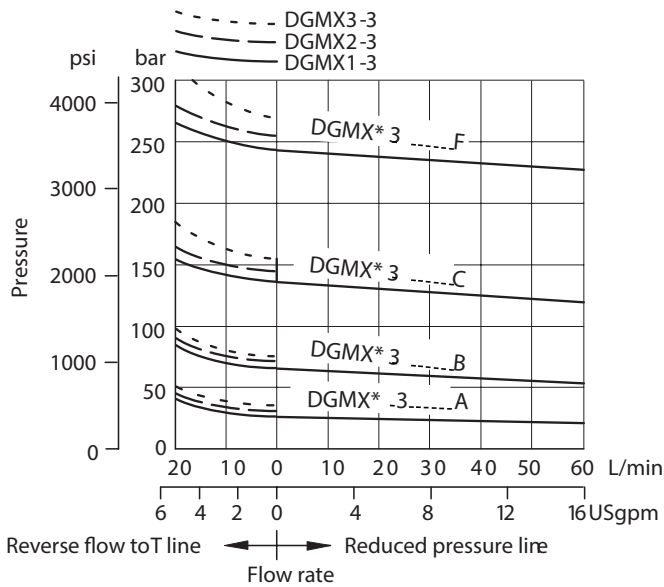

DGMR1-3-PP

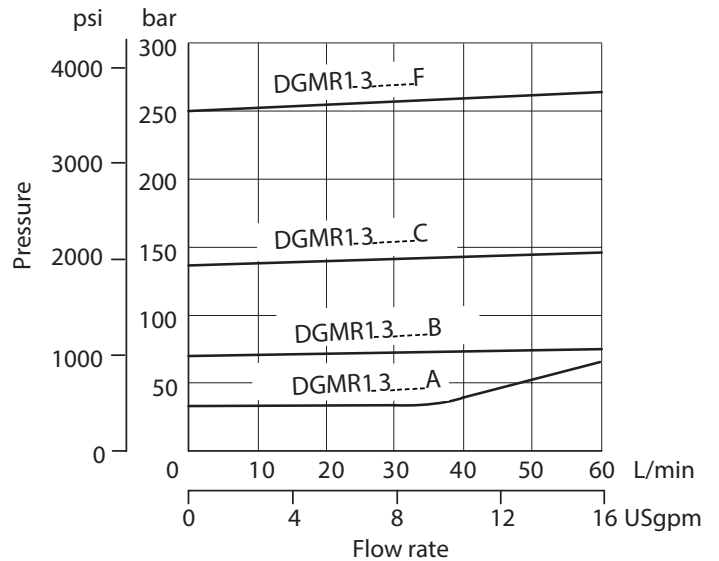

Performance Data

(contd...)



DGMX*-3-P*

Low Pressure/Flow Rate Minimum Performance

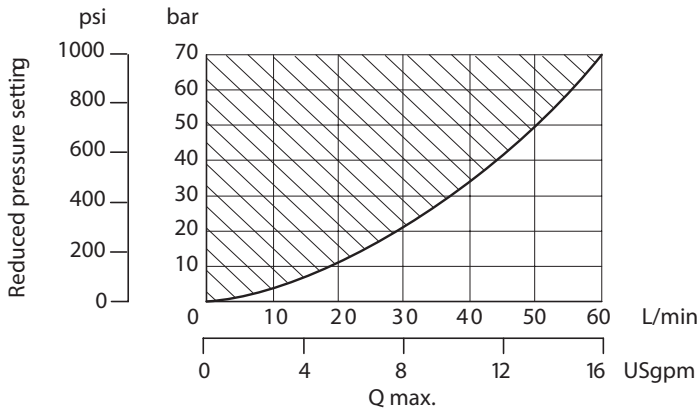

Effect of Back-Pressure

The effective reduced pressure is equal to the valve adjustment setting plus any back-pressure in line T

Dead Head Leakage

Typical leakage flow at 250 bar inlet pressure from reduced pressure line into T at "Dead Head" condition (i.e. No flow required at the reduced pressure outlet.)

This leakage flow must be provided at the inlet line P in order to maintain the reduced outlet pressure.

DGMX1-3 = 1600
DGMX2-3 = 400
DGMX3-3 = 80

Installation Dimensions

in mm (inches)

DGMR-3-TA-**-*-40

DGMR1-3-PP-**-*-40

DGMX(*)-3-P*(L)-**-*-40

Models with type W adjuster

To adjust valve setting slacken off locknut and turn adjuster screw. ■

■ Turn clockw to increase pressure; counter-clockwise to decrease pressure.

Re-tighten locknut after completing adjustment. DGMX2-3-**-*L models have adjuster and end cap/gage port locations interchanged from positions shown.

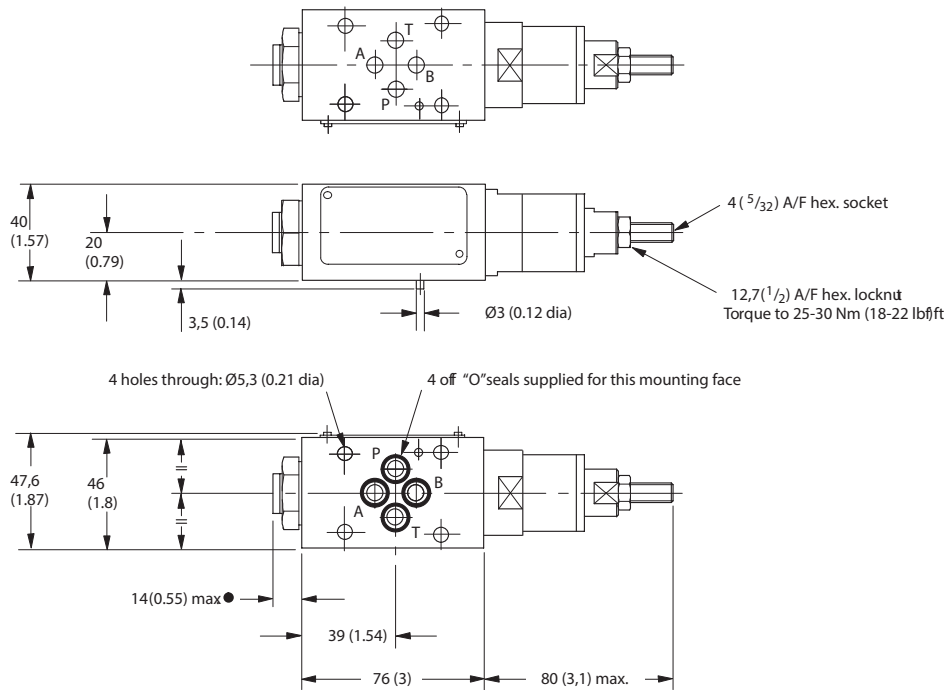
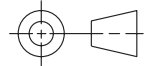

● For gage port thread options see model code
(pressure plug fitted)

DGMDC-3-41

Typical Section

General Description

These valves allow free flow in one direction in the line in which the check valve element(s) is (are) located; flow in the opposite direction is not possible.

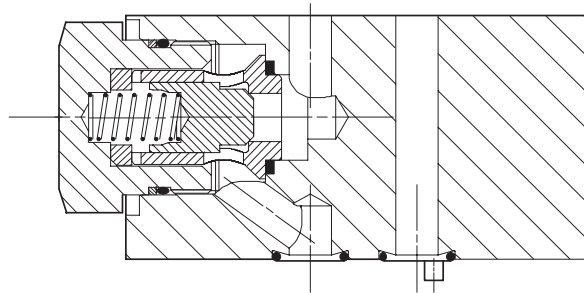

Model Code

DGMDC -3- * - * * (-* *) - 41

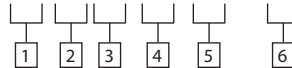

1 Direction of flow

X – Free flow away from actuator
Y – Free flow towards actuator

2 Check location

A – A line
B – B line
P – P line with free flow towards actuator (X)
T – T line with free flow away from actuator(Y)

3 Check valve opening/ cracking pressure

K – 1 bar (14.5 psi)
M – 2,5 bar (36 psi)
N – 5 bar (72 psi)

4 Check location (second element of dual model)

Only available as model type DGMDC-3-Y-A*-B*-4*
B – B line

5 Check valve opening/ cracking pressure (second function of dual model)

Options as in **3**

6 Design number, 40 series

Subject to change. Installation dimensions unchanged for design numbers 40 to 49 inclusive.

Functional Symbols

DGMDC-3-X-A*

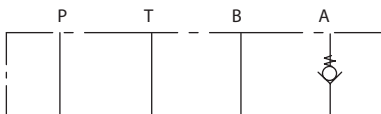

DGMDC-3-YA*

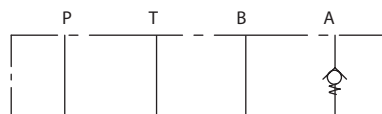

DGMDC-3-X-B*

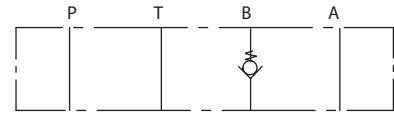

DGMDC-3-YB*

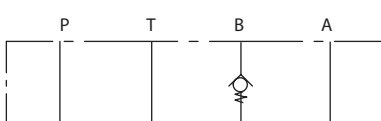

DGMDC-3-YP*

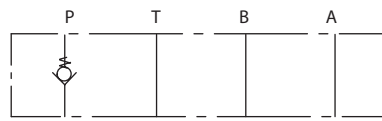

DGMDC-3-X-T*

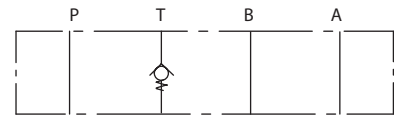

DGMDC-3-YA*-B*

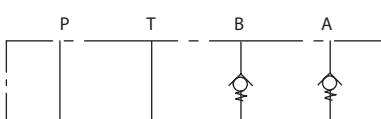

Maximum flow rate	60 L/min (16 USgpm)
Maximum operating pressure	315 bar (4500 psi)
Pressure drops	See graphs
Mounting position	Optional
Mass approximate	1 kg (2.2 lb)

Performance Characteristics

Typical performance with mineral oil at 21 cSt (102 SUS) and at 50°C(122°F) ●

Pressure drop: free flow through check valve

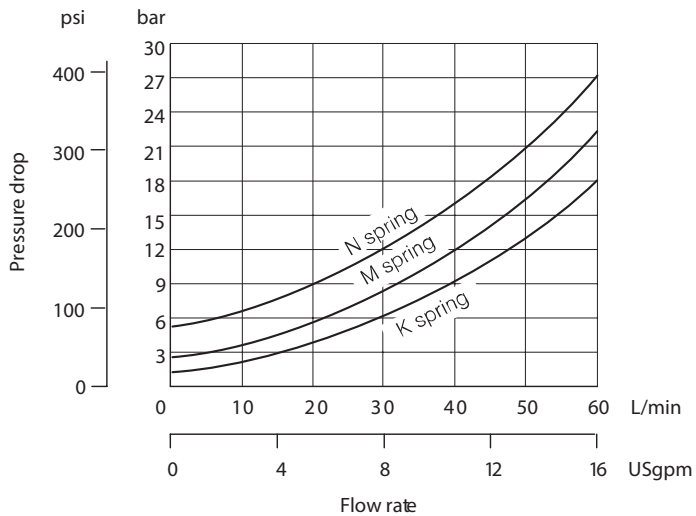

● For other viscosities, see "Further Information".

Internal Leakage Across Closed Check Valve

Less than 0,25 ml/min (0.015 in³/min) at 250 bar (3625 psi)

Installation Dimensions in mm (inches)

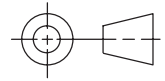

DGMDC-3-Y-A*-B*-41

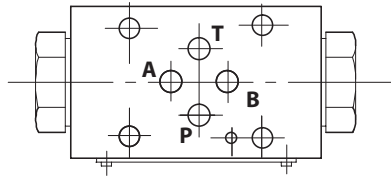

DGMDC-3-X-A*-41
DGMDC-3-X-T*-41
DGMDC-3-Y-A*-41
DGMDC-3-Y-P*-41

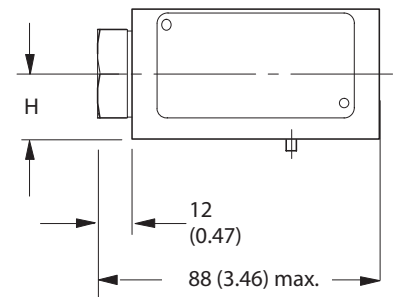
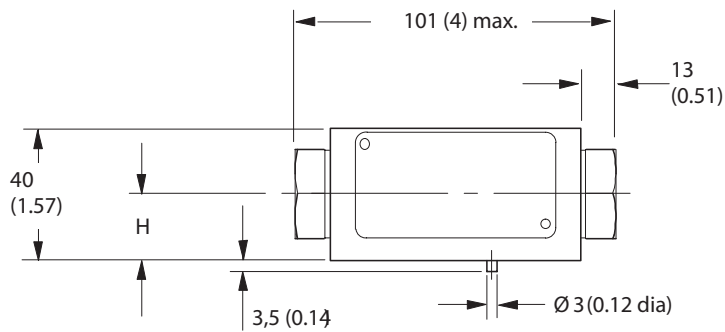
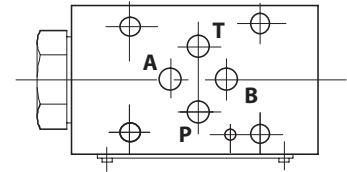

4 holes through $\varnothing 5,3$ (0.21 dia)

4 off "O" seals supplied for this mounting face

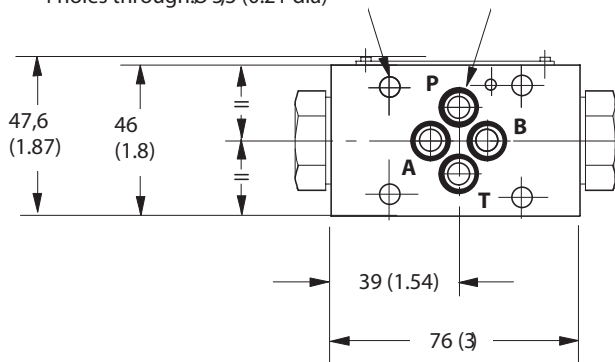

DGMDC-3-X-B*-41
DGMDC-3-Y-B*-41

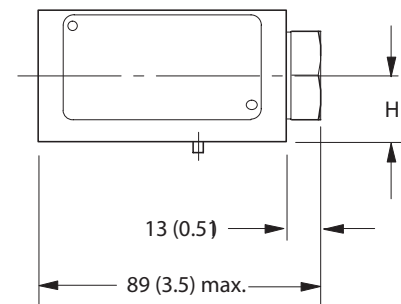

ModelType	H
DGMDC-3-X-A*-41	
DGMDC-3-X-B*-41	16,75
DGMDC-3-Y-P*-41	(0.66)
DGMDC-3-X-T*-41	
DGMDC-3-Y-A*-41	23,25
DGMDC-3-Y-B*-41	(0.92)
DGMDC-3-Y-A*-B*-41	

DGMPC-3-41

General Description

These valves provide pilot operated check functions in one or both service lines (A or B), the operating pilot supply coming from the opposite service line. Thus with pressure in one service line the check valve in the other service line will be open (subject to system/actuator pressures being correct for the valve area ratios).

A 3:1 area ratio of pilot piston to check valve seat is supplemented by an optional 10:1 decompression feature.

Typical Section

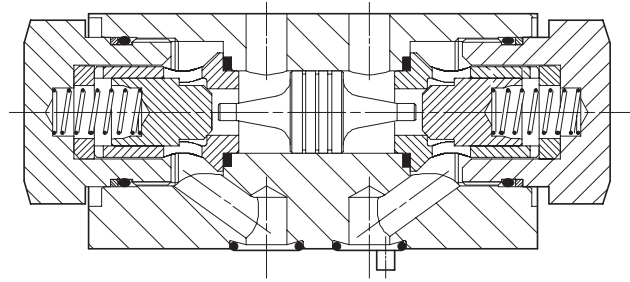

Model Code

DGMPC -3- (D)** * [-(D)** *] - 41

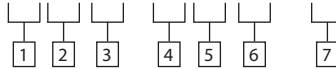

1 Decompression feature

D – 10:1 decompression ratio
Omit if not required

2 Function

AB – Check in line A, pilot operated from line B
D – Check in line B, pilot operated from line A (single check model only)

3 Check valve opening/cracking pressure

K – 1 bar (14.5 psi)
M – 2,5 bar (36 psi)
N – 5 bar (72 psi)

4 Decompression feature (second function of dual models)

As in 1
Omit for single line models, and if not required for dual models

Note: "D" must be specified here, for dual models, if called for in

5 Second function of dual models

BA – Check in line B, pilot operated from line A
Omit for single line models

6 Check valve opening/cracking pressure (second function of dual models)

Options as in 3
Omit for single line models

7 Design number, 41 series

Subject to change. Installation dimensions unchanged for design numbers 40 to 49 inclusive.

Functional Symbols

DGMPC-3-(D)AB*-(D)BA*

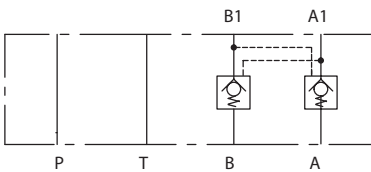

DGMPC-3-(D)AB*

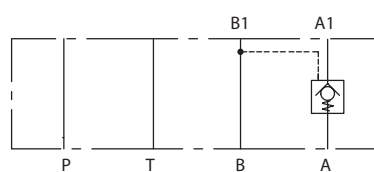

DGMPC-3-(D)BA*

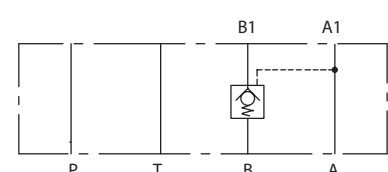

Maximum flow rate	60 L/min (16 USgpm)
Maximum operating pressure	315 bar (4500 psi)
Pressure drops	See graphs
Mounting position	Optional
Mass approximate	0.8 kg (1.81 lb)

Performance Data

Pressure Drop Data

Typical performance with mineral oil at 21 cSt (102 SUS) and at 50°C(122°F)

Pressure drop: flow path A1 to A or B1 to B (no pilot-pressure operation)

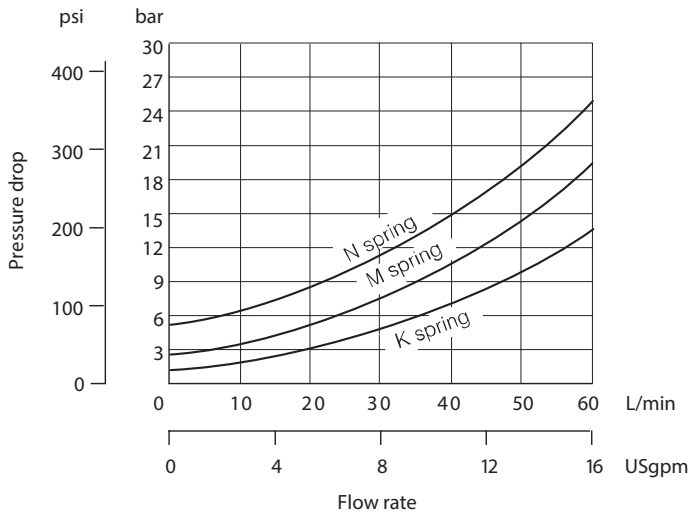

Pressure drop: flow path A to A1, or B to B1 with check valve pilot-operated fully open

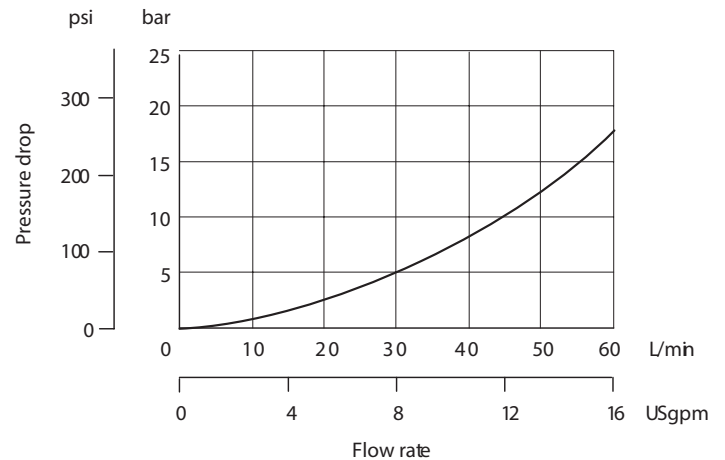

u For other viscosities, see "Further Information".

Pilot Pressures

Pilot area ratios:

Main check valve 3:1

Decompression poppet 10:1

Use applicable ratio and opening/cracking pressure to calculate pilot pressure to open valve element, applied to the following formulae:

To open valve or decompression poppet in line A:

$$\text{Pressure at B1} = \frac{p_A + p_C - p_{A1}}{\text{Area ratio factor}} + p_{A1}$$

To open valve or decompression poppet in line B:

$$\text{Pressure at A1} = \frac{p_B + p_C - p_{B1}}{\text{Area ratio factor}} + p_{B1}$$

Where:

p_A = Pressure at A

p_C = Cracking/opening pressure

p_{A1} = Pressure at A1

p_B = Pressure at B

p_{B1} = Pressure at B1

A = }
 B = } Service line location;
 A1 = } see functional symbols
 B1 = }

Leakage

Less than 0,25 ml/min (0.015 in³/min) at 250 bar (3625 psi).

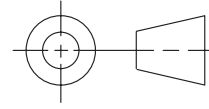

DGMPC-3-(D)AB*-(D)BA*-41

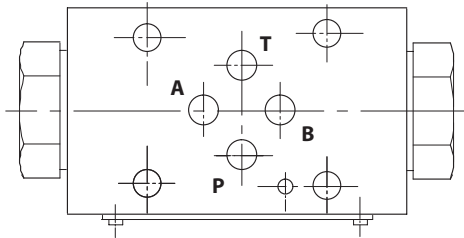

DGMPC-3-(D)AB*-41

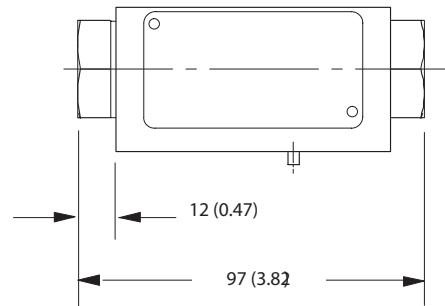
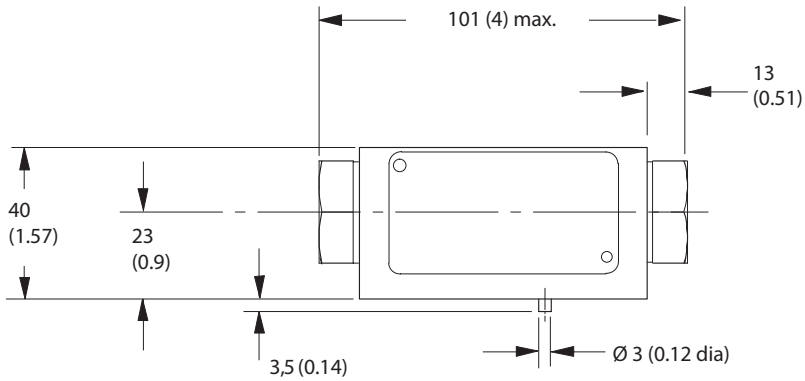
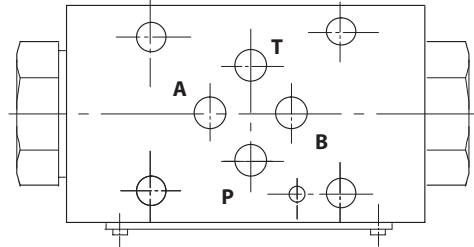

4 holes through: Ø 5,3 (0.21 dia)

4 off "O" seals supplied for this mounting face

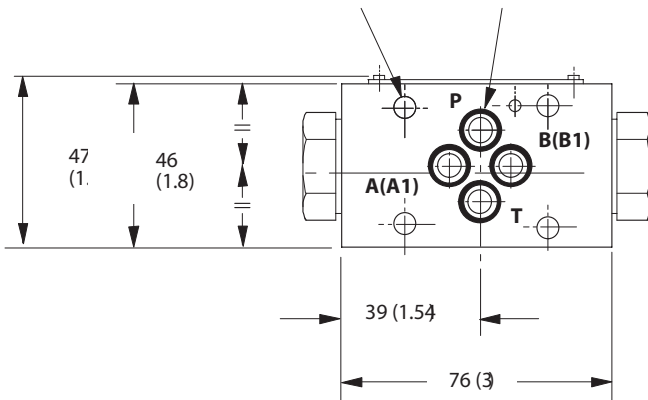

DGMPC-3-(D)BA*-41

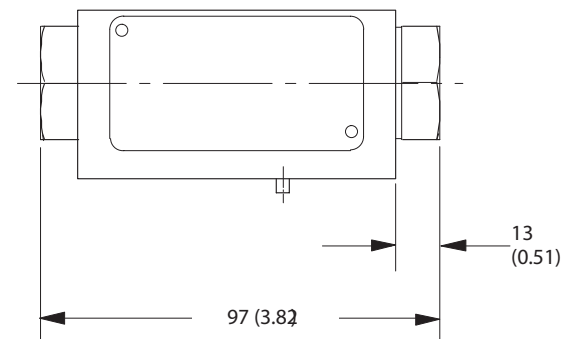

DGMFN-3-41

General Description

These valves regulate flow by means of an adjustable orifice which is not pressure compensated, and flow through the valve is entirely dependent upon pressure drop at any particular setting of the orifice.

Dual service-line models with an integral non-return valve around each control orifice provide for meter-in or meter-out control; single line versions of these are available.

For flow restriction in P or T lines (where reverse free flow is not required) models without check valves are available.

Adjustment options are either screw/locknut or handknob.

Typical Section

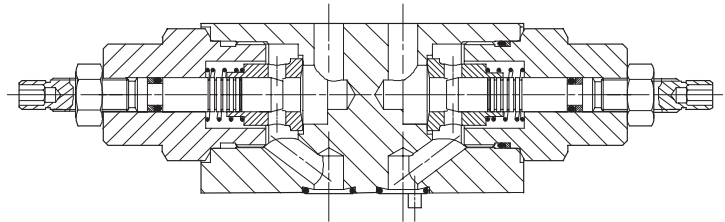

Model Code

DGMFN -3- * -* * * (-* * *) - 41

└─┬─┘
└─┬─┘
└─┬─┘
└─┬─┘
└─┬─┘
└─┬─┘
└─┬─┘
└─┬─┘

1
2
3
4
5
6
7
8

1 Direction of flow control (with respect to machine actuator)

- X** – Meter-in control, applicable to lines A and B
- Y** – Meter-out control, applicable to lines A and B
- Z** – Meter-in control, line P only and meter-out control, line T only.

2 Location of control function (single model or first line of dual model)

- P** – Line P (single model only)
- T** – Line T (single model only)
- A** – Line A (single model or first line of dual model)
- B** – Line B (single model only)

3 Type of control needle/orifice (single model or first line of dual model)

- 1** – Fine control
- 2** – Standard control

4 Adjuster type (single model or first line of dual model)

- H** – Handknob
- W** – Screw/locknut

5 Control in second line

- B** – Line B (use for dual models with "A" specified at **2**)
- Omit for single models

6 Type of control needle/orifice (second line of dual models)

- Options as in **3**
- Omit for single models

7 Adjuster type (second line of dual models)

- Options as in **4**
- Omit for single models

8 Design number, 41 series

- Subject to change. Installation dimensions unaltered for design numbers 40 to 49 inclusive.

DGMFN-3-X-A**-B**

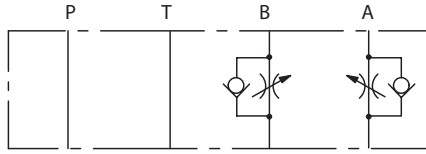

DGMFN-3-YA**-B**

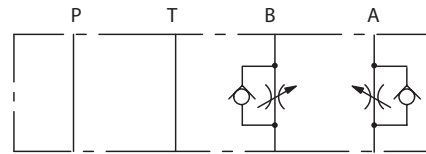

DGMFN-3-Z-P**

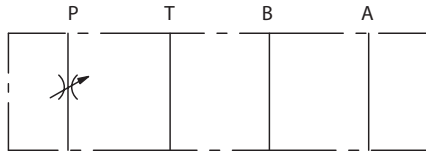

DGMFN-3-Z-T**

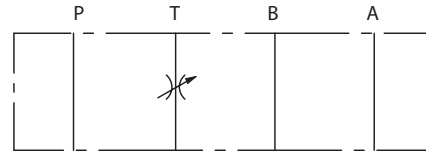

Operational Data

Maximum flow rate	60 L/min (16 USgpm)
Maximum operating pressure	315 bar (4500 psi)
Pressure drops	See graphs
Mounting position	Optional
Mass approximate	1.1 kg (2.2 lb)

Performance Characteristics

Pressure Drop

Typical performance with mineral oil at 21 cSt (102 SUS) and at 50° C (122° F)

Type "1" needle (see model codes and) 6

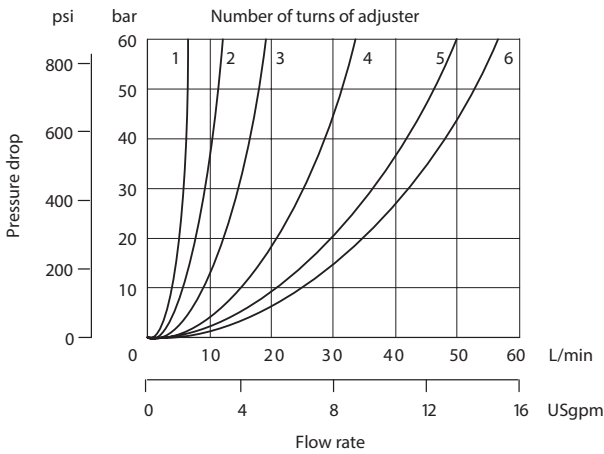

Type "2" needle (see model codes and) 6

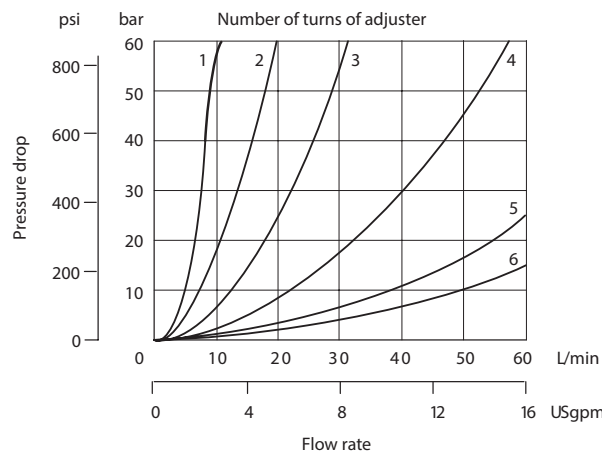

Free flow through check valve

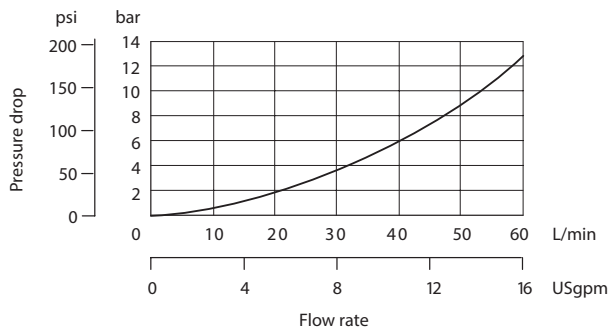

● For other viscosities see "Further Information".

Installation Dimensions in mm (inches)



DGMFN-3-X-*(-***)-41**
DGMFN-3-Y-*(-***)-41**
DGMFN-3-Z-*-41**

Models with type W adjuster

To adjust valve setting, slacken off locknut and turn screw ■
 Re-tighten locknut after completing adjustment.

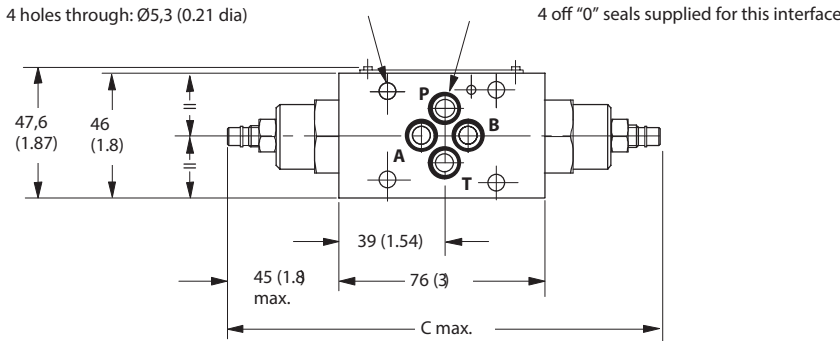
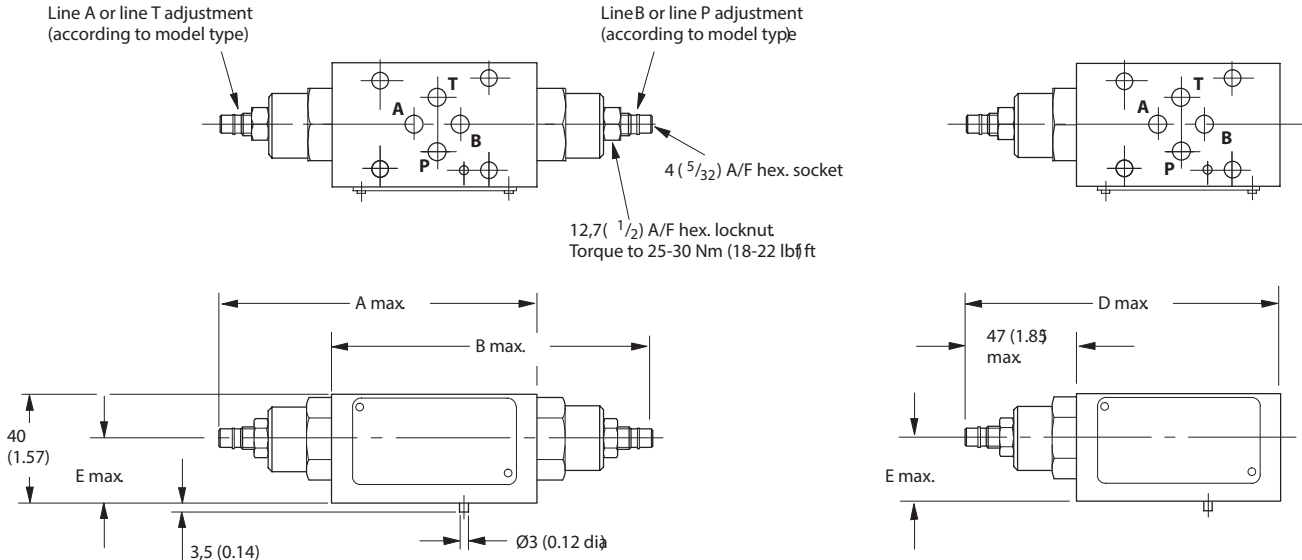
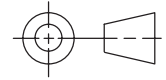

Type H adjuster

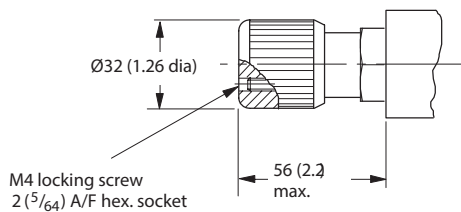

■ Turn clockwise to decrease flow (increase restriction);
 counter-clockwise to increase flow (reduce restriction).

Model	A	B	C	D	E
DGMFN-3-X-A*W-41	121 (4.76)	-	-	-	16,75 (0.7)
DGMFN-3-X-A*W-B*W-41	-	-	167 (6.6)	-	16,75 (0.7)
DGMFN-3-X-B*W-41	-	122 (4.8)	-	-	16,75 (0.7)
DGMFN-3-Y-A*W-41	121 (4.76)	-	-	-	23,25 (0.9)
DGMFN-3-Y-A*W-B*W-41	-	-	167 (6.6)	-	23,25 (0.9)
DGMFN-3-Y-B*W-41	-	122 (4.8)	-	-	23,25 (0.9)
DGMFN-3-Z-P*W-41	-	-	-	123 (4.8)	16,75 (0.7)
DGMFN-3-Z-T*W-41	-	-	-	123 (4.8)	23,25 (0.9)

Mounting Bolts, Subplates and Manifold Blocks

Mounting Bolts

The length of mounting bolt used to install a SystemStak assembly is dependent on the number of valves being used, plus the length needed for mounting other valves in the assembly, such as:

- solenoid operated, or other type of directional valve
- tapping plate
- blanking or crossover plate

Danfoss offers a large selection of bolt kits (one bolt kit for these SystemStak valves comprises 4 bolts) in metric and inch sizes as listed. To determine your needs, use the following guide for bolt length calculation.

Bolt Kit Selection

Metric: M5-6g		Inch: 10-24 UNC-3A	
Length (mm)	Danfoss bolt kit number	Length (in)	Danfoss bolt kit number
50	BKDG3699M	2.0	BKDG3698
60	BK466836M	2.375	BK466849
70	BK464125M	2.75	BK870017
80	BK466837M	3.125	BK466850
90	BK466838M	3.5	BK466851
100	BK466839M	3.937	BK466852
110	BK466840M	4.312	BK466853
120	BK466841M	4.75	BK466854
130	BK466842M	5.125	BK466855
140	BK466843M	5.5	BK466856
150	BK466844M	5.937	BK466857
160	BK466845M	6.312	BK466858
170	BK466846M	6.687	BK466859

Subplates and Manifold Blocks

See "Subplates and Auxiliary Connection Plates" catalog 2425.

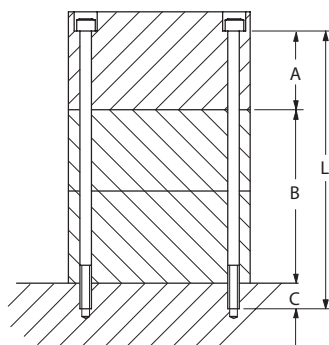

A = Bolt clamp length in directional valve, blanking plate, crossover plate, etc.

B = Height of intermediate valve stack, comprising Danfoss SystemStak valve(s) plus tapping plates, etc.

C = Depth of thread engagement in subplate/ manifold block: 8/10 mm (0.3/0.4), valid for: 315 bar (4500 psi) when using cast iron or steel subplates/manifold blocks, or 210 bar (3045 psi) when using Danfoss aluminium alloy manifold blocks.

L = Required bolt length; select from the table.

Notes

1. Bolts should be torqued to 7-9 Nm (63-80 lbf in) with threads lubricated.
2. If not using Danfoss bolt kits, bolts must be to Grade 12.9 (ISO 898) or better.

Pressure Drop at Other Viscosities

Published pressure drop data is valid for a fluid viscosity of 21 cSt (102 SUS). The graph shows the approximate percentage change in pressure drop for a range of other viscosities. To determine the approximate pressure drop for any given fluid viscosity, multiply the published data by the % factor for the required viscosity.

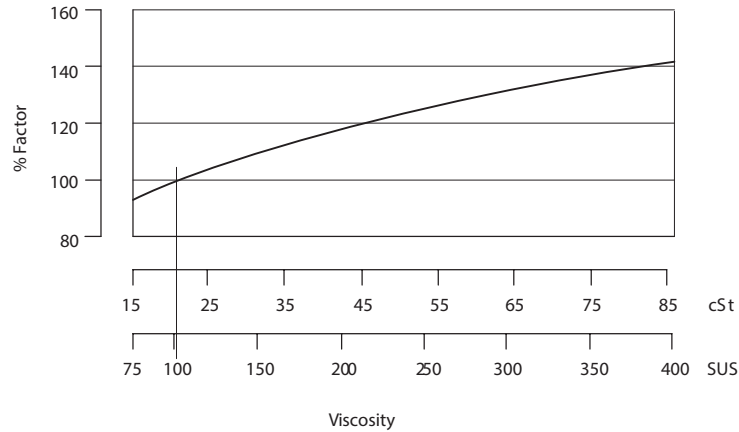

Type H Adjuster

To adjust valve setting, slacken M4 locking screw and rotate knob. Re-tighten locking screw after completing adjustment.

Available on
 DGMC-3
 DGMR-3
 DGMX-3

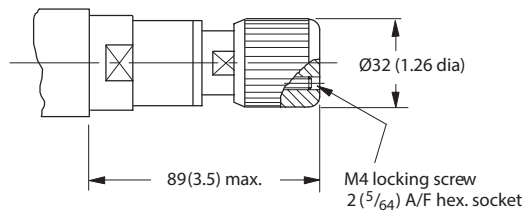

Type K Adjuster

Key must be inserted and turned to allow valve to be adjusted. When key is removed, adjustment mechanism can be freely turned without changing valve setting.

Available on
 DGMC-3
 DGMR-3
 DGMX-3

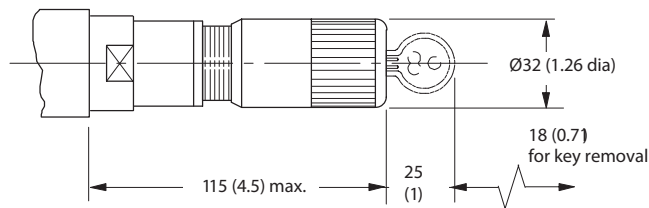

- Turn clockwise to increase pressure; counter-clockwise to decrease pressure

Products we offer:

- Cartridge valves
- DCV directional control valves
- Electric converters
- Electric machines
- Electric motors
- Gear motors
- Gear pumps
- Hydraulic integrated circuits (HICs)
- Hydrostatic motors
- Hydrostatic pumps
- Orbital motors
- PLUS+1® controllers
- PLUS+1® displays
- PLUS+1® joysticks and pedals
- PLUS+1® operator interfaces
- PLUS+1® sensors
- PLUS+1® software
- PLUS+1® software services, support and training
- Position controls and sensors
- PVG proportional valves
- Steering components and systems
- Telematics

Danfoss Power Solutions is a global manufacturer and supplier of high-quality hydraulic and electric components. We specialize in providing state-of-the-art technology and solutions that excel in the harsh operating conditions of the mobile off-highway market as well as the marine sector. Building on our extensive applications expertise, we work closely with you to ensure exceptional performance for a broad range of applications. We help you and other customers around the world speed up system development, reduce costs and bring vehicles and vessels to market faster.

Danfoss Power Solutions – your strongest partner in mobile hydraulics and mobile electrification.

Go to www.danfoss.com for further product information.

We offer you expert worldwide support for ensuring the best possible solutions for outstanding performance. And with an extensive network of Global Service Partners, we also provide you with comprehensive global service for all of our components.

Local address:

Hydro-Gear

www.hydro-gear.com

Daikin-Sauer-Danfoss

www.daikin-sauer-danfoss.com

**Danfoss
Power Solutions (US) Company**
2800 East 13th Street
Ames, IA 50010, USA
Phone: +1 515 239 6000

**Danfoss
Power Solutions GmbH & Co. OHG**
Krokamp 35
D-24539 Neumünster, Germany
Phone: +49 4321 871 0

**Danfoss
Power Solutions ApS**
Nordborgvej 81
DK-6430 Nordborg, Denmark
Phone: +45 7488 2222

**Danfoss
Power Solutions Trading
(Shanghai) Co., Ltd.**
Building #22, No. 1000 Jin Hai Rd
Jin Qiao, Pudong New District
Shanghai, China 201206
Phone: +86 21 2080 6201