

# Operating manual

## Wärtsilä JOVYREC D600 G120/10

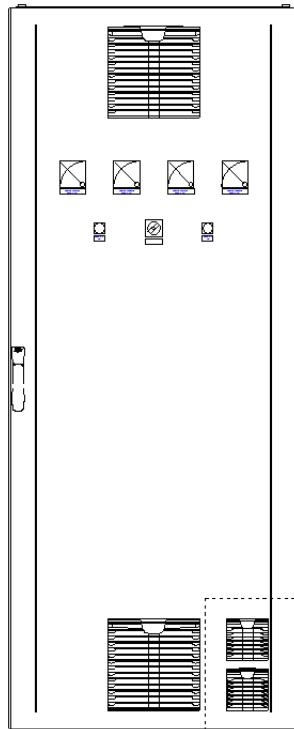

# 150254\_10\_BA



Wärtsilä JOVYATLAS EUROATLAS GmbH  
Fennenweg 4, 26844 Jemgum, Germany  
[www.jovyatlas.de](http://www.jovyatlas.de)

Tel. +49 (0)4958 9394 - 0  
Fax. +49 (0)4958 9394 - 10

Rev.	Date	Name	Change
0	24.05.2019	J. Schulte	First Edition
1			
2			
3			
4			
5			
6			
7			
8			
9			
10			

## Important notes

### Please read these instructions carefully

These instructions contain specifications concerning safety, installation and work procedures that will help you put our product to optimal use. They must be read carefully before beginning assembly and installation of the product. They must be accessible to both the product's assembler and operator.

### Please keep these instructions in a safe place

They contain important specifications and notes concerning use of the product as well as notes concerning questions and problems.

### Validity

Our goods and services are subject to the general terms of delivery for products of the electronics industry as well as our general sales conditions. We reserve the right to make changes to these instructions – in particular as regards the technical data, operating instructions and the weights and dimensions – at any time. These instructions correspond to the product's technical version at the time of publication. Their contents are not part of any contract but are for information purposes only.

Wärtsilä JOVYATLAS EUROATLAS GmbH reserves the right to make substantive and technical changes regarding the content of these instructions without prior notification. Wärtsilä JOVYATLAS EUROATLAS GmbH cannot be held liable for any errors or inaccuracies in these instructions, as there is no obligation to provide regular updates.

### Complaints

Complaints must be submitted to the manufacturer at the latest eight days after delivery of the product.

### Copyright

Any disclosure, reproduction and/or copying of these instructions, by electronic or mechanical means, in whole or in part, requires the express prior written consent of Wärtsilä JOVYATLAS EUROATLAS GmbH.

Copyright Wärtsilä JOVYATLAS EUROATLAS GmbH. All rights reserved.

## Table of Contents

1	Technical Data	4
2	Safety Regulations	5
2.1	Important Instructions and Explanations	5
2.2	Safety Notes / Precautions	5
2.3	Electrical Safety Precautions	5
2.4	Handling of Elelctrostatic Discharge Sensitive Assemblies	6
2.5	General Information	6
2.6	Accident Prevention Regulations	6
2.7	Danger Entailed During Maintenance and Repair Work	6
2.8	Fire Hazard	7
2.9	Qualified Personnel	7
2.10	Safety Awareness	7
2.11	Application	7
2.12	Liability	8
2.13	Regulations	8
3	Description	8
3.1	General information	8
3.2	Function specification of the rectifier	8
3.3	Specification of the rectifier	9
3.4	Battery undervoltage monitoring	9
3.5	Supply voltage failure	9
3.6	Isolation monitoring	10
3.7	Status circuit breaker load output	10
4	Transport, Storage and Erection	10
4.1	General	10
4.2	Visual control	10
4.3	Packaging	10
4.4	Transport	10
4.5	Site Conditions	12
4.6	Floor Mounting	12
4.7	Storage	12
4.8	Installation and Cabinet Interconnections	12
5	Putting into operation	13
6	Maintenance	14
6.1	Introduction	14
6.2	Preventive Maintenance	15
6.3	Troubleshooting	15
7	Spare Parts and Customer Service	16
8	Drawings & data sheets	16

## 1 Technical Data

Mains supply (X1)	
Voltage	: 3 x 600VAC $\pm$ 10%
Frequency	: 50Hz $\pm$ 5%
Rated current	: 3 x 5A
Output	
Nominal Output Voltage	: 136,2VDC $\pm$ 1% (2,27V per cell)
Ripple	: 5%RMS
Current	: 10A $\pm$ 2% limited

General	
Operating mode	: Continuous operation
Protective system	: IP 54
Ambient temperature	: 0°C...+40°C
Noise level	: <60dBA
Width x Height x Depth UPS	: 800mm x 2000mm x 600mm
Weight UPS	: Approximate 200kg
Varnishing	: RAL 7035

### Indicating- and operating elements

Voltmeter P1 0...150VDC	: Output voltage rectifier 1
Voltmeter P3 0...150VDC	: Output voltage rectifier 2
Ampere meter P2 0...15ADC	: Output current rectifier 1
Ampere meter P4 0...15ADC	: Output current rectifier 2

Rotary switch S1	: 1 - Rectifier 1 ON
	: 0 – OFF
	: 2 – Rectifier 2 ON
Rotary switch S2 (inside)	: Reset low discharge protection
Signal lamp H1	: Rectifier 1 ON
Signal lamp H2	: Rectifier 1 ON

### Remote indication

#### Potential free contacts for:

- Rectifier 1 fault
- Rectifier 2 fault
- Mains failure
- DC – overvoltage
- DC - undervoltage
- Insulation failure
- Fuse failure Distribution

## 2 Safety Regulations

### 2.1 Important Instructions and Explanations

The instructions for operation and maintenance as well as the following safety regulations must be complied with to safeguard the safety of personnel as well as the function of the unit. All personnel in-stalling/dismantling, starting up, and servicing the unit must be familiar with and observe these safety regulations. Only qualified personnel may perform the described work with suitable and intact tools, equipment, test equipment and materials. Important instructions are highlighted by "CAUTION:", "ATTENTION:", "NOTE:" and indented text.



**CAUTION:**

This symbol identifies all working and operational procedures requiring absolute compliance to avoid any danger to personnel.



**ATTENTION:**

This symbol identifies all working and operational procedures requiring absolute compliance to prevent any damage, irreparable or otherwise, to the rectifier or its components.

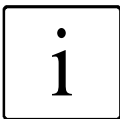

**NOTE:**

This symbol identifies technical requirements and additional information requiring the operator's attention.

### 2.2 Safety Notes / Precautions

Operation and maintenance procedures must be performed only by qualified personnel. The following rectifier operation and maintenance requirements must be observed at all times to assure maximum safety and performance.

Operate, service, and maintain the units as described in this manual.

Thoroughly understand unit and system operation and functions.

Understand all controls, indicators, and operating limits.

Before operating the rectifier, learn the significance of possible malfunctions and be prepared to take appropriate action if one occurs.

Understand and observe the following safety notices and precautions.

### 2.3 Electrical Safety Precautions

The rectifier must be considered energized unless all sources of input power and batteries have been removed and circuits are checked for voltage by an independent voltmeter.

Capacitors can retain voltage for long periods of time. All capacitors should be discharged with an adequate device by qualified personnel before rectifier maintenance, troubleshooting or repair is performed.

When switches have been opened or fuses removed to de-energize a circuit for maintenance, the switches and fuses should be tagged out to prevent accidental closure or replacement.

To the fullest extent possible, all rectifier maintenance should be conducted with external power removed.

When it is absolutely necessary to work on energized equipment, the following precautions must be observed:

- Never ground test equipment to live buses.
- Insulate all surrounding circuitry not under inspection with sheet rubber or dry heavy weight paper.
- Stand only on rubber matting.
- Use one hand only and wear insulating rubber gloves.
- Wear safety glasses.
- Never work alone.
- Personnel qualified in CPR (cardiopulmonary resuscitation) should be readily available.

For personnel safety and equipment protection keep all access doors and panels securely fastened or locked at all times.

For personnel safety and equipment protection never remove a printed circuit board or fuse from an energized circuit.

Never override or bypass an interlock or safety device during operation.



**ATTENTION:**

The rectifier must be considered energized unless input isolation and output isolation switch is confirmed open.

## **2.4 Handling of Electrostatic Discharge Sensitive Assemblies**

Electrostatic discharge (ESD) precautions must be observed when trouble-shooting, handling, aligning, adjusting, removing, repairing, replacing, un-packing, or repackaging ESD sensitive items. The following items are considered ESD sensitive:

All printed wiring board assemblies.

All parts, assemblies, and equipment marked ESD sensitive.

Internal and external cable connectors when one end is still attached to an ESD sensitive item.

Drawers or panels when open, disconnected, or removed from the top assembly.

## **2.5 General Information**

The following general instructions are given as a reminder for personnel trained in ESD prevention. These ESD instructions do not represent a complete list of precautionary measures which must be observed to prevent ESD damage.

Only personnel trained in the use of ESD preventive devices, tools, and techniques are to handle ESD sensitive items.

Synthetic clothing is not to be worn when handling ESD sensitive items. Synthetic cloth is not to be used as cleaning rags, all cotton cloth is preferred.

A properly grounded ESD wrist strap which makes contact with bare skin is to be worn when handling ESD sensitive items.

ESD sensitive items will be placed only on properly grounded ESD protective matting when not installed in equipment.

ESD sensitive items are not to be transported without proper ESD protective coverings, packaging and markings.

Do not damage or discard materials used to package ESD sensitive items. The packing material can be re-used to return defective items.

Do not allow connector pins of ESD sensitive items to contact a non-ESD protected surface.

## **2.6 Accident Prevention Regulations**

Compliance with the accident prevention regulations valid in the country of application and the general safety regulations in accordance with IEC 364 is mandatory.

The following must be observed prior to any work on the rectifier:

- disconnect the power supply,
- secure against reactivation,
- verify that the unit is disconnected from the power supply,
- earth and short the circuit,
- cover or isolate any neighbouring power-supplied units.

## **2.7 Danger Entailed During Maintenance and Repair Work**



**CAUTION:**

The voltage applied to the rectifier can be fatal. Prior to start-up or maintenance work always disconnect the rectifier from the power supply and the batteries and ensure that the unit cannot be switched on. The capacitors must be discharged. Freestanding and movable components can enter the work area and cause injuries.



**ATTENTION:**

Considerable damage can be caused to equipment if unsuitable spare parts are used during repair work, if work is carried out by unauthorised personnel or the safety regulations are not observed.

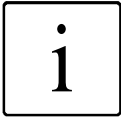

**NOTE:**

Only trained and qualified personnel may work on or around the rectifier while strictly observing the safety regulations.

## **2.8 Fire Hazard**

Structure of fireproof enclosures (EN 60950)

If the rectifier is installed in rooms with inflammable floors (e.g. textile, wood, PVC), a floor plate must also be installed. The assembler is responsible for proper installation.



**CAUTION:**

If smoke is detected or a fire breaks out, immediately disconnect the rectifier from the power supply and inform the maintenance personnel.

## **2.9 Qualified Personnel**

The rectifier may only be transported, installed, connected, started, serviced and operated by qualified personnel who are familiar with the pertinent safety and installation regulations. All work performed must be inspected by responsible experts.

The qualified personnel must be authorised to perform the work by the competent safety officer.

Qualified personnel is defined as personnel

- having completed training and gained experience in the respective field,
- familiar with the pertinent standards, rules and regulations and accident prevention regulations,
- having received instruction on the mode of operation and operating conditions of the rectifier.
- capable of recognising and preventing dangers.
- Regulations and definitions for qualified personnel are contained in DIN 57105/VDE 0105, Part 1.

## **2.10 Safety Awareness**

The personnel defined in upper chapter are responsible for safety and must ensure that only suitably qualified persons are permitted access to the safety area or to be in the proximity of the rectifier.

The following points must be observed:

- All working procedures are prohibited which are detrimental to the safety and operation of the rectifier in any way.
- The rectifier may only be operated in perfect working condition.
- Never remove or render inoperable any safety devices.

All necessary operational measures must be initiated prior to deactivation of any safety devices for maintenance, servicing or any other work on the unit.

Safety awareness also entails informing colleagues of any unsuitable behaviour and reporting any detected faults to the respective authority or person.

## **2.11 Application**

The rectifier may only be used for power supply with the maximum permissible connected loads in accordance with these operating instructions in the described mode of installation and operating mode. The device may only be used for this intended purpose. It is not permitted to make any unauthorised modifications to the rectifier or to use any spare parts and replacement parts not approved by JOVYATLAS GmbH or to use the device for any other purpose.

The person responsible for the installation must ensure that:

- safety instructions and operating instructions are readily available and are complied with,
- operating conditions and technical data are observed,
- safety devices are employed,
- the prescribed maintenance work is performed,
- maintenance personnel is informed or that the device is shut down immediately in the event of abnormal voltages or noises, high temperatures, vibration or any similar effects in order to detect the cause.

These operating instructions contain all information required by qualified personnel for operation of the rectifier. Additional information for unqualified personnel and for the use of the rectifier in non-industrial applications is not included in these operating instructions.

The warranty obligations of the manufacturer are only applicable when these operating instructions are complied with.

## **2.12 Liability**

No liability is accepted if the rectifier is used for applications not intended by the manufacturer. Any necessary measures for prevention of injury or damage to equipment is the responsibility of the operator or user. In the event of any claims in connection with the rectifier please contact us quoting:

- the type designation,
- works number,
- reason for claim,
- period of use,
- ambient conditions,
- operating mode.

## **2.13 Regulations**

The rectifier devices comply with current DIN and VDE regulations. VBG4 is met on the basis of compliance with the regulation DIN EN 50274.

The CE sign on the device confirms the conformance to the basic EC regulations for -72/23 EEC - Low voltage and for -89/336 EEC - Electromagnetic compatibility, if the installation and commissioning instructions described in the operating manual are observed!

## **3 Description**

The 120V DC-supply essentially consists of two combined charging-/power rectifiers, explained in the following. The supply outputs are de-coupled by power diodes.

### **3.1 General information**

The unit complies with the valid DIN- and VDE-stipulations.

Each rectifying unit have been designed to supply power to DC loads with a 60-cell lead battery in parallel operation readiness.

Each rectifier is suited to supply power to the DC-load in continuous battery power supply. The rectifiers essentially consists of a radio interference suppression filter, as well as miscellaneous alarm and control circuits.

The battery is charged with one of both charging-/power rectifiers (in de-pendent of switch-position S1: 1 – Rectifier 1 ON / 2 – Rectifier 2 ON. In case of rectifier failure the second rectifier can take over the load supply and battery charging. Should both rectifiers fail, the battery will take over the task of supplying power without interruption.

### **3.2 Function specification of the rectifier**

The rectifier is connected to the power supply by terminal rail X1 (L1,L2,L3,PE).

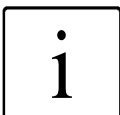

NOTE:

Please ensure that the phase-sequence rotates in a clockwise direction!



The power-converter transformer T1 is fed in via the mains. The transformer T1 supplies the adapted voltage for the switching power supply. Furthermore, insulating the primary and secondary windings results in a galvanic disconnection between the input and the output.

The rectifiers A1 and A2 transform the AC-voltage to an DC-Voltage and supplying the load and charging the batteries.

### **3.3 Specification of the rectifier**

The control unit is designed as a switching power supply. Including the voltage adaption, current limiting, Alarm LED and EMI filters. The manual is attached to this manual.

#### **3.3.1 Monitoring unit**

The printed wiring board monitors the following faults:

- Rectifier failure,
- rectifier is overheating,

All of the fault messages are generated as a collective alarm on the control circuit board. These signals are sent potential-free as a collective signal to the terminal rail X3.

The following fault and operating condition is made available for further processing. The fault signal result as follows:

- Rectifier 1 fault : X3.1...X3.2 open  
X3.2...X3.3 closed
- Rectifier 1 fault : X3.4...X3.5 open  
X3.5...X3.6 closed

When the facility is functioning properly the contact is according in the opposite state.

#### **3.4 Battery undervoltage monitoring**

An undervoltage monitoring facility has been installed for the battery. The PCB A6 monitors the voltage of the connected battery. The voltage-value is adjusted at approx. 99VDC.

The signal 'Battery undervoltage' is sent potential-free to the terminal rail X3. The following faults and operating conditions are made available for further processing. The fault signals result as follows:

- Battery undervoltage : X3.13...X3.14 open  
X3.14...X3.15 closed

When the facility is functioning properly the contacts are according in the opposite state.

#### **3.5 Supply voltage failure**

A phase failure relay is installed for monitoring the mains-supply of the rectifier. The assembly A5 monitors the input voltage for an phase sequence - and an phase failure. The supply voltage failure signal is sent potential-free to the terminal rail X3.

The following fault- and operating condition is made available for further processing. The fault signals result as follows:

- Mains fault : X3.7...X3.8 open  
X3.8...X3.9 closed

When the facility is functioning properly the contacts are according in the opposite state.

### 3.6 Isolation monitoring

The DC-voltage will be monitored continuously by the earth fault monitoring device A9. The earth fault failure signal is sent potential-free to the terminal rail X3.

The following faults and operating conditions are made available for further processing. The fault signals result as follows:

- Earth fault : X3.16...X3.17 open  
X3.17...X3.18 closed

### 3.7 Status circuit breaker load output

The circuit breakers of the distribution panel will be monitored of switched off position and fuse failure. The circuit breaker failure signal will be sent potential-free to the terminal rail X3.

The following faults and operating conditions are made available for further processing. The fault signals result as follows:

- Fault ACB load output : X3.18...X3.19 open

## 4 Transport, Storage and Erection

### 4.1 General

This section contains guidelines for the installation of the rectifier including equipment unloading, placement, inspection, and interconnection. The concerning drawings are located in annex.

### 4.2 Visual control

Perform a thorough visual inspection of the rectifier prior to installation. Inspect all items for any shipping damage, finish defacement, assembly, and component damage. Ensure all plug in devices are firmly seated. Inspect all panel, assembly, and component markings for legibility. Notify the manufacturer immediately if any equipment damage or deficiency is found.

### 4.3 Packaging

The rectifier units are packed at the works to withstand both rail and road transport. The housing is secured to the pallet with taut bands. The unit is packed in plastic film to prevent any damage to the surface paint and protect the device against moisture.

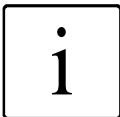

**NOTE:**

To prevent damage only remove the film immediately prior to installation.  
The taut bands can then be removed with a knife.

### 4.4 Transport

#### 4.4.1 Crane Transport (Option)



**CAUTION:**

Do not walk under suspended loads!  
Always wear protective clothing such as a helmet, safety shoes and gloves!  
Transport the unit with due care and observe the safety regulations!



**ATTENTION:**

Only transport the charging rectifier in an upright position!  
Never tilt or cant, always observe the centre of gravity!

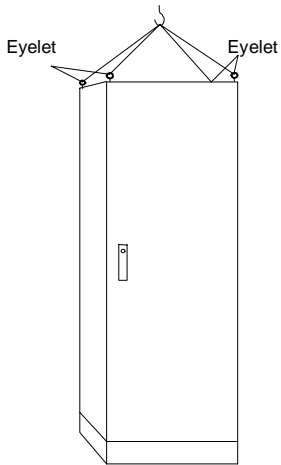

The length of the cables is calculated so that an angle of 45° is given between the cable and the top edge of the cabinet (DIN 580). The minimum load capacity of each cable must be  $\geq 0.5$  times the weight of the cabinet (DIN 580). The weight of each charging rectifier is contained in Chapter 'Technical Data'. One cable must be used for each eyelet.

Proceed as follows to transport the unit by crane:

- Check the four transport eyelets in the threaded bores on the top of the cabinet for fixed mounting.
- Hook in the four cables.
- Carefully lift the charging rectifier and transport the unit to its intended site.
- Carefully lower the charging rectifier without jolting the unit.
- Remove the cables and eyelets.

#### **4.4.2 Transporting the Unit with a Forklift and Lowlift Truck**



**ATTENTION:**

Prior to transport always ensure that the transport devices used for the rectifier are designed for the respective load.

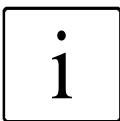

**NOTE:**

Transport with a forklift or lowlift truck should be avoided whenever possible, especially on construction sites and uneven ground.

Always transport by crane when possible!

Preparation:

- Leave the rectifier on the transport pallet.
- Remove the base covering.

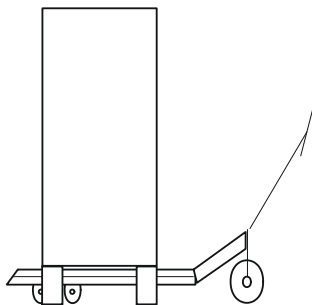

Transport with lowlift truck

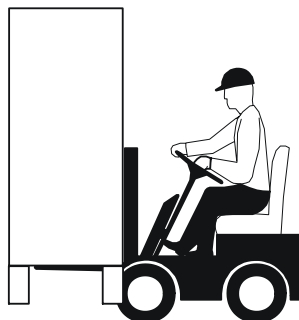

Transport with forklift truck



**ATTENTION:**  
Observe the centre of gravity!  
The lifting arms must be sufficiently long and sufficiently far apart.

Proceed as follows:

- Insert the lifting arms between the transport pallet and the rectifier.
- Carefully lift the rectifier and transport the unit to its intended location.
- Lower the rectifier carefully without jolting the unit.
- Retract the forklift or lowlift truck.
- Refit the base covering with the securing bolts.

#### **4.5 Site Conditions**

Suitable floor surfaces are:

- double floors,
- above cable ducts or
- directly on a level surface.

Ensure that the weight of the rectifier device does not exceed the maximum floor bearing capacity.

The site must also:

- be free from conductive dust,
- free from corrosive or acid fumes
- the intake air temperature must not exceed 45°C
- the ventilation openings on the rectifier should not be obstructed by any constructional features or other measures.

Rectifier devices are suitable for installation in confined spaces. It must be ensured that a 800mm space is provided in front of the device to ensure an escape route and 100mm above the unit to ensure unobstructed air venting.

#### **4.6 Floor Mounting**

Four bores are provided in the base frame of the rectifier for the securing bolts. The spacing and diameter of the bores are contained in the Dimensional drawing in annex.

Before securing the unit to the floor ensure that it is vertically aligned in order to compensate for any unevenness (e.g. using metal wedges).

#### **4.7 Storage**

Rectifier units may only be stored for a maximum period of six months in the original packaging in dry, ventilated rooms with a permanent roof. The permissible ambient temperature range is from -35°C to +70°C and a relative humidity of ≤ 95 % is mandatory.

If the device is stored for longer than six months the rectifier units must be provided with normal desiccants and welded into airtight plastic covering.

#### **4.8 Installation and Cabinet Interconnections**



**CAUTION:**  
Verify that all power has been removed.  
From external cables prior to installation. Secure and tag out external power sources where applicable.

#### 4.8.1 Installation

The rectifier has to be installed at the final destination as following:

Compare dimensional drawings in appendix.

Place the rectifier carefully at the planned location and fix it at the socle.

For maintenance the rectifier needs a distance of at least 80cm in front of the device.

The rectifier is cooled by air inlets in front door of the cabinet. For unhindered air-exchange these areas must be free.

The rectifier has to be installed in a dry and clean room with a sufficient air-exchange. If this is not guaranteed, the room has to be adequately air-conditioned.

For the installation dimensions see the diagrams in the appendix.

The rectifier is designed to be installed for wall mounting.

#### 4.8.2 Cabinet interconnections

The rectifier should be interconnected per drawing 'Terminal Board' in annex.

The suitable diameters of cables and the sizes of the fuses are to be de-signed with regard to the environmental temperature, the cable grouping and length of cables according to the local rules and according to VDE!



##### CAUTION:

Works on electrical equipment are to be done only by qualified personnel. The corresponding safety-rules has to be fulfilled. The marking of wires has to be done in accordance to DIN 40705, 02.80 and DIN EN 60445, 09.91!

- Connect rectifier mains supply to X1.
- The earth connection is made at terminal PE.
- The battery is internal wired!
- Connect the floating loads according to requirements to X2. The cable cross-sections for the output cables should be selected on the basis of the output currents.
- Connect signalisation lines to X3 according to requirements (refer to circuit- and terminal diagram in annex).

The following faults and operating conditions are made available for further processing:

- X3.1-X3.3 : Rectifier 1 fault
- X3.3-X3.6 : Rectifier 2 fault
- X3.7-X3.9 : Mains failure
- X3.10-X3.12 : DC-overvoltage
- X3.13-X3.15 : DC-undervoltage
- X3.16-X3.17 : Insulation failure
- X3.18-X3.19 : Output circuit breaker tripped

#### 4.8.3 General information

The wire diameters have to be calculated concretely considering the actual environmental conditions! At larger distances the permissible voltage drop, the surrounding temperature and the cable grouping have to be dimensioned according to VDE. Local rules for the protection earth-wires have to be considered.

### 5 Putting into operation

- Before switching on the rectifiers make sure, that the battery fuses F4 have been removed.
- Switch on rectifier 1 or rectifier 2 with the rotary-switch S1, the corresponding lamp H1 or H2 will light up.
- A value of 136,2V must be displayed by the corresponding voltmeter P1 or P3.
- Insert the battery fuses.

**ATTENTION:**

Only insert the battery fuses when the charging rectifier is in operation !

- Remove the battery fuses if the UPS-system is not to be used for long periods !
- When switching on again, proceed as described above.

Starting is thus concluded.

## **6 Maintenance**

### **6.1 Introduction**

This section provides information for routine preventive maintenance and general fault recognition guidelines for proper operation of the rectifier. Physical maintenance or troubleshooting must be performed only by personnel trained on the rectifier. Operating personnel not trained and instructed in the maintenance of rectifier equipment should limit their efforts to identifying the symptoms of a fault.



**ATTENTION:**

Before performing maintenance inside rectifier cabinet, shut down the unit!

## **6.2 Preventive Maintenance**

The continued monitoring of the operational status of any electronic equipment is essential for assuring system reliability. Operating personnel should be knowledgeable of all rectifier equipment and indicators. Records should be maintained for all rectifier preventive maintenance activities. The rectifier requires periodic preventive maintenance. The following procedures should be performed by personnel familiar with basic electronics and electrical theory who have been trained in rectifier operations.

1. Ensure all fans are operational and that adequate ventilation is available.
2. Check for any unusual noises or odors.
3. Check the operating- and display elements and verify that an alarm condition is not indicated.
4. Inspect, if present, the fan assembly air filter and replace if necessary.
5. The cooling ducts have to be cleaned regular.
6. The set values for the output voltage and the monitoring facility should be checked annually.
7. Shorted fuses should only be replaced with fuses of the same type (current value and triggering characteristics)!

## **6.3 Troubleshooting**

Troubleshooting is a logical, methodical process involving tests, measurements, observations, and deductive reasoning. It proceeds from a general recognition that a failure condition exists to a specific determination of the cause or causes of the failure and localization of the failure to one or more specific components.

Successful troubleshooting of all but the most obvious failures (e.g. blown fuses, defective fan, etc.) requires an in-depth technical background in electronics technology. Specifically, one needs a solid education, including dc and ac circuits, solid state devices, and digital electronics. In addition, a solid background in three phase power systems is also necessary.

Troubleshooting requires the use of a dual trace (or two channel) oscilloscope, a digital multimeter, a phase rotation meter and other electronic instruments. Any one lacking experience with these instruments or the above cited technical background should NOT attempt to troubleshoot the rectifier.

## 7 Spare Parts and Customer Service

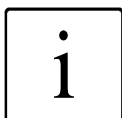

**NOTE:**

When ordering spare parts please always state the designation (position/component) and unit number.

We draw your attention to the fact that spare parts not supplied by us are not tested or approved. Installation of such spare parts can therefore have a detrimental effect on the operation and passive safety of the unit. We do not accept any liability for any resulting damage.

Our customer service department will be pleased to send you a complete spare part list for your rectifier upon request.

Please contact the following address in this case or if you should have any questions or suggestions.

# SERVICE-HOTLINE!

Phone : 04958 - 9394 - 30    Fax: 04958 - 9394 - 10

E-Mail: [service.jovyatlas.de@wartsila.com](mailto:service.jovyatlas.de@wartsila.com)    Internet: <http://www.jovyatlas.de>

## 8 Drawings & data sheets

- |   |                         |                      |
|---|-------------------------|----------------------|
| - | Circuit diagram         | 150254_10_ZG         |
| - | Battery data sheet      | JL205680             |
| - | Manual Rectifier module | Wärtsilä JOVYREC PME |





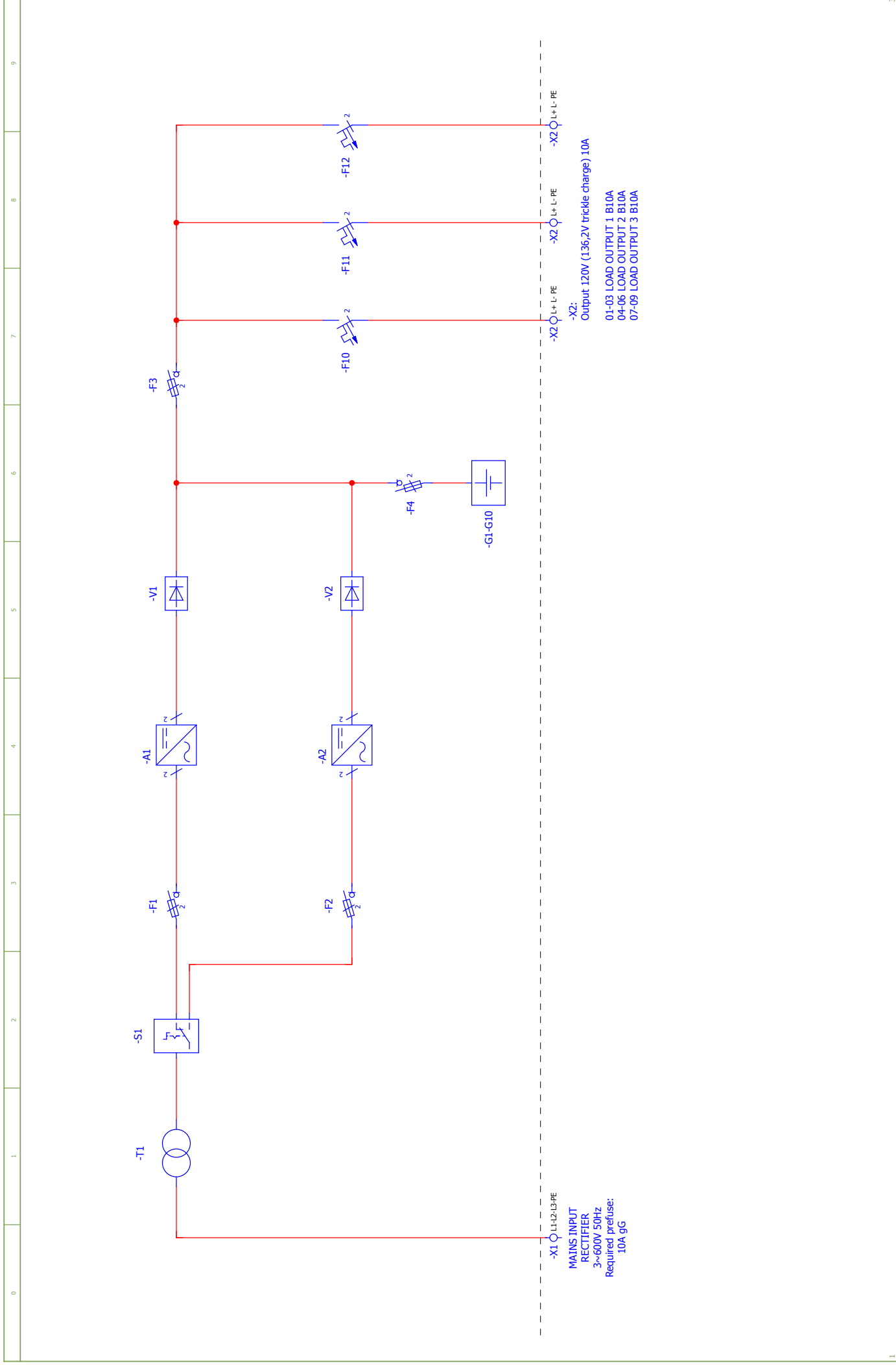

-X1 L1-L2-L3-PE  
**MAINS INPUT  
 RECTIFIER**  
 3~600V 50Hz  
 Required prefuse:  
 10A gG

-X2 L+ L- PE  
**Output 120V (136.2V trickle charge) 10A**  
 01-03 LOAD OUTPUT 1 B10A  
 04-06 LOAD OUTPUT 2 B10A  
 07-09 LOAD OUTPUT 3 B10A

Zustand: Revisions:		Datum: Date:		Name: Name:		Ungang: Origin:		Ersetzt durch: Substitution of:		Ersetzt durch: Substitution of:	
		24.05.2019		Hinrichsen & Vasey Operaciones		Hinchisem & Vasey Operaciones		Hinchisem & Vasey Operaciones		Hinchisem & Vasey Operaciones	
		J. Schulte		Calle Riquelme 550		Calle Riquelme 550		Calle Riquelme 550		Calle Riquelme 550	
		C. Fochleiter		Talcahuano, Concepcion		Talcahuano, Concepcion		Talcahuano, Concepcion		Talcahuano, Concepcion	
				CHILE		CHILE		CHILE		CHILE	
				Wartsila JOVYATLAS EUROATLAS GmbH		Wartsila JOVYATLAS EUROATLAS GmbH		Wartsila JOVYATLAS EUROATLAS GmbH		Wartsila JOVYATLAS EUROATLAS GmbH	
				Ferienweg 4, 28944 Jemgum, Germany		Ferienweg 4, 28944 Jemgum, Germany		Ferienweg 4, 28944 Jemgum, Germany		Ferienweg 4, 28944 Jemgum, Germany	
				www.jovyatlas.com		www.jovyatlas.com		www.jovyatlas.com		www.jovyatlas.com	
				Beschreibung / Description:		Beschreibung / Description:		Beschreibung / Description:		Beschreibung / Description:	
				Wartsila JOVYREC D600 G120/10		Wartsila JOVYREC D600 G120/10		Wartsila JOVYREC D600 G120/10		Wartsila JOVYREC D600 G120/10	
				Input: 3~600V 50Hz		Input: 3~600V 50Hz		Input: 3~600V 50Hz		Input: 3~600V 50Hz	
				Output: 136.2VDC (trickle charging)		Output: 136.2VDC (trickle charging)		Output: 136.2VDC (trickle charging)		Output: 136.2VDC (trickle charging)	
				Max. 10A		Max. 10A		Max. 10A		Max. 10A	
				Zeichnung Nr.: 150254_10_ZG		Zeichnung Nr.: 150254_10_ZG		Zeichnung Nr.: 150254_10_ZG		Zeichnung Nr.: 150254_10_ZG	
				Auftrags-Nr.: 150254 - 10,000		Auftrags-Nr.: 150254 - 10,000		Auftrags-Nr.: 150254 - 10,000		Auftrags-Nr.: 150254 - 10,000	
				Übersicht:		Übersicht:		Übersicht:		Übersicht:	
				Allgemeine Bezeichnung / General description:		Allgemeine Bezeichnung / General description:		Allgemeine Bezeichnung / General description:		Allgemeine Bezeichnung / General description:	
				Single line		Single line		Single line		Single line	
				=		=		=		=	
				+		+		+		+	
				Allgemeine Bezeichnung / General description:		Allgemeine Bezeichnung / General description:		Allgemeine Bezeichnung / General description:		Allgemeine Bezeichnung / General description:	
				DIN ISO 2768-m		DIN ISO 2768-m		DIN ISO 2768-m		DIN ISO 2768-m	
				Blatt: 2 von 6		Blatt: 2 von 6		Blatt: 2 von 6		Blatt: 2 von 6	
				Seite 10 protection robot ISO 2010		Seite 10 protection robot ISO 2010		Seite 10 protection robot ISO 2010		Seite 10 protection robot ISO 2010	

Front view

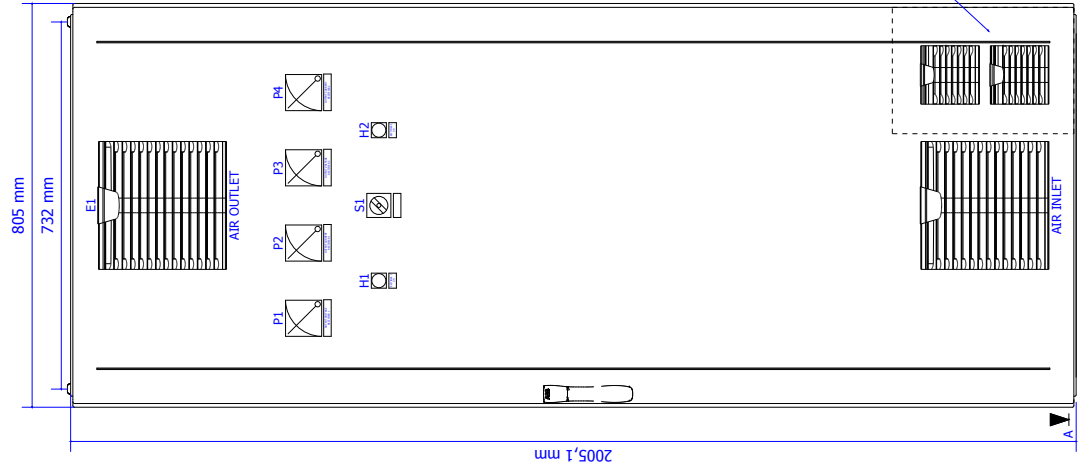

Side view

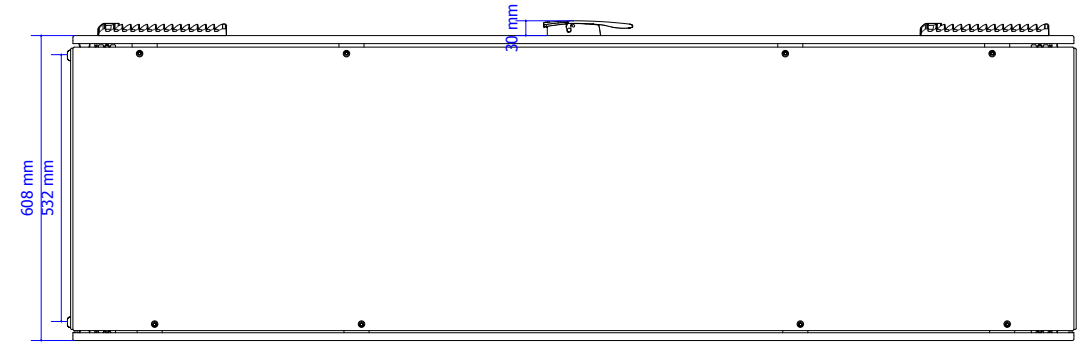

Cutaway view A-A (Foundation UPS-Cabinet)

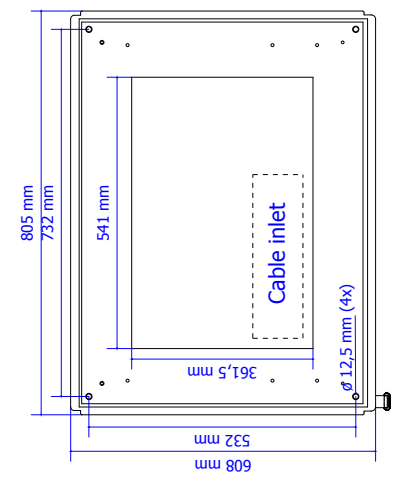

- P1 OUTPUT VOLTAGE RECTIFIER 1
- P2 OUTPUT CURRENT RECTIFIER 1
- P3 OUTPUT VOLTAGE RECTIFIER 2
- P4 OUTPUT CURRENT RECTIFIER 2
- S1 1 - RECTIFIER 1 ON  
0 - OFF
- H1 RECTIFIER 2 ON  
2 - RECTIFIER 1 ON
- H2 RECTIFIER 2 ON

CABINETS  
 MANUFACTURER: ABB  
 TYPE: BASED ON IS 2  
 VARNISHING: RAL 7035  
 PROTECTION DEGREE: IP 54  
 WEIGHT: approx. 200Kg

Zustand/Revision:		Datum/Date:		Name:		Ungering/Origin:		Ersetzt durch/ Substitution of:		Ersetzt durch/ Substitution of:	
c		24.05.2019		Hinrichsen & Vasey Operaciones		Munich: Genit:		Hinchisken & Vasey Operaciones		Wartsila JOVYATLAS EUROATLAS GmbH	
b		J. Schulte		Calle Riquelme 550		Wartsila JOVYREC D600 G120/10		Talakahuano, Concepcion		Dimension drawing	
a		C. Fochleiter		CHILE		Input: 3~600V 50Hz		CHILE		Drawing No.: 150254_10_ZG	
						Output: 136,2VDC (trickle charging)				Alignment tolerances: DIN ISO 2768-m	
						Max. 10A				Drawing No.: 150254_10_ZG	
										Order No.: -150254_-10,000	
										Sheet: 3 von 6	
										Page: 4	



\*X\*: Short circuit proofed wired

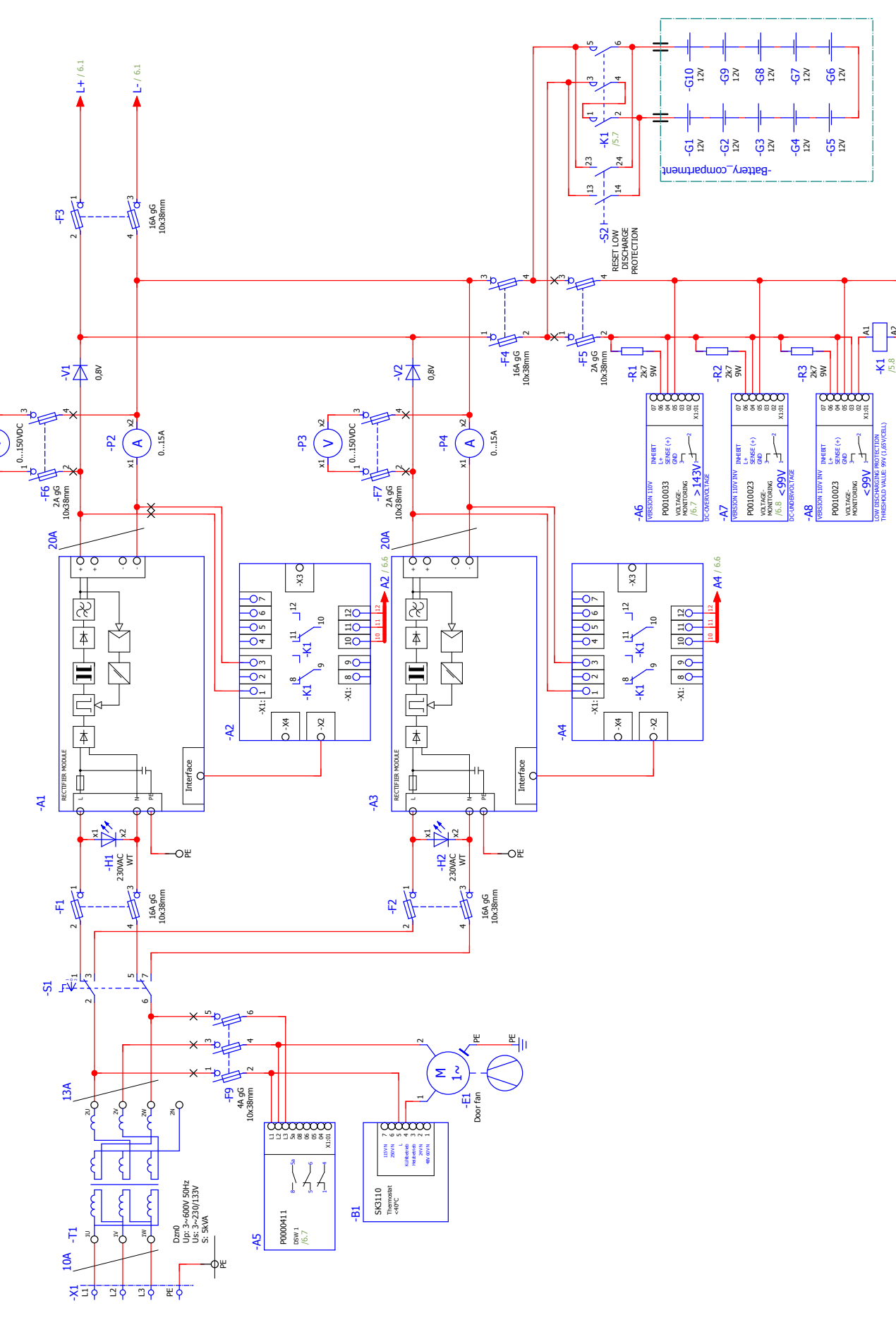

**MAINS INPUT  
RECTIFIER  
3~600V 50Hz  
Required prefuse:  
10A gG**

Dzr0  
Up: 3~600V 50Hz  
Us: 3~230/133V  
S: 5kVA

4	Date:		24.05.2019	Number:	Hinrichsen & Vasey Operaciones	Project description:	Algemeine Beschaltung / General description:
5	Name:		J. Schulte	Client:	Calle Riquelme 550	Circuit diagram	
6	Gen'de:		C. Fichtler	Location:	Talcahuano, Concepcion		
7	Checked:			Country:	CHILE		
8	Drawing no.:		150254_10_ZG	Order ref.:			
9	Drawing no.:		150254_10_ZG	Order ref.:			
10	Drawing no.:		150254_10_ZG	Order ref.:			
11	Drawing no.:		150254_10_ZG	Order ref.:			
12	Drawing no.:		150254_10_ZG	Order ref.:			
13	Drawing no.:		150254_10_ZG	Order ref.:			
14	Drawing no.:		150254_10_ZG	Order ref.:			
15	Drawing no.:		150254_10_ZG	Order ref.:			
16	Drawing no.:		150254_10_ZG	Order ref.:			
17	Drawing no.:		150254_10_ZG	Order ref.:			
18	Drawing no.:		150254_10_ZG	Order ref.:			
19	Drawing no.:		150254_10_ZG	Order ref.:			
20	Drawing no.:		150254_10_ZG	Order ref.:			



WARTSILA JOYVATLAS EUROATLAS GmbH  
Ferienweg 4, 26844 Jürgenum, Germany  
www.joyvatlas.com

Project description:  
Wartsila JOVREC D600 G120/10  
Input: 3~600V 50Hz  
Output: 136.2VDC (trickle charging)  
Max. 10A



# JL205680

## Specifications

Nominal Voltage		12 V
Capacity (25°C)	20HR(10.5V)	12Ah
	10HR(10.5V)	11Ah
	1HR(9.60V)	7.8Ah
Dimension	Length	151±1.5mm (5.94inch)
	Width	98±1mm (3.86inch)
	Height	95±1mm (3.74inch)
	Total Height	101±1mm (3.98inch)
Approx. Weight		3.6kg (7.94lbs)±5%
Terminal type		T2/T1
Internal resistance (Fully charged, 25°C)		Approx. 19mΩ
Capacity affected by temperature (20HR)	40°C	102%
	25°C	100%
	0°C	85%
	-15°C	65%
Self-discharge (25°C)	3 month	Remaining Capacity: 91%
	6 month	Remaining Capacity: 82%
	12 month	Remaining Capacity: 65%
Nominal operating temperature		25°C ± 3°C (77°F ± 5°F)
Operating temperature range	Discharge	-15°C ~ 50°C (5°F ~ 122°F)
	Charge	-10°C ~ 50°C (14°F ~ 122°F)
	Storage	-20°C ~ 50°C (-4°F ~ 122°F)
Float charging voltage(25°C)	13.60 to 13.80V Temperature compensation: -18mV/°C	
Cyclic charging voltage(25°C)	14.50 to 14.90V Temperature compensation: -30mV/°C	
Maximum charging current	3.6A	
Terminal material	Copper	
Maximum discharge current	180A(5 sec.)	
Designed floating life(20°C)	10~12years	



## Dimensions

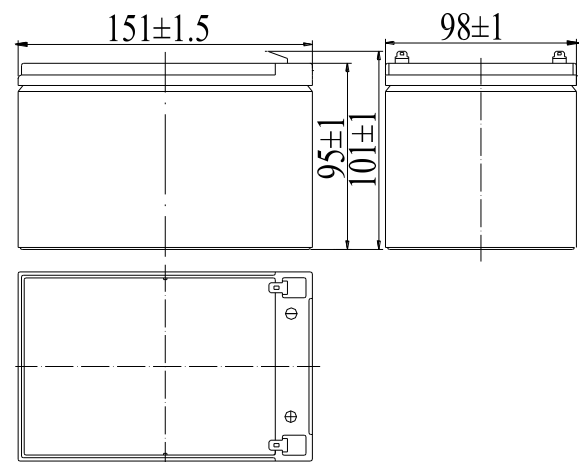

## Terminal

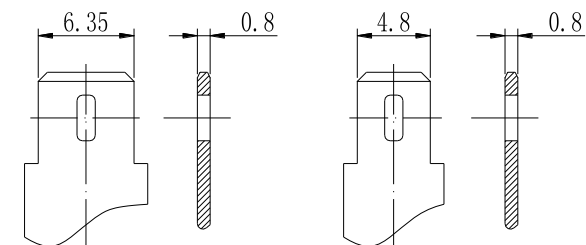

Terminal T2

Terminal T1

◆ Absorbent glass mat technology;

◆ Recognized by UL & CE;

◆ ABS container.

## Constant Current Discharge Characteristics (A, 25°C)

F.V/TIME	10min	15min	30min	60min	2h	3h	4h	5h	8h	10h	20h
9.60V	28.8	22.8	12.7	7.80	4.26	3.06	2.45	2.08	1.35	1.13	0.61
9.90V	27.9	22.3	12.5	7.68	4.24	3.04	2.43	2.07	1.34	1.13	0.61
10.2V	26.8	21.4	12.1	7.49	4.20	3.02	2.42	2.05	1.33	1.12	0.60
10.5V	25.6	20.7	11.8	7.34	4.14	3.00	2.40	2.04	1.32	1.12	0.60
10.8V	24.2	19.6	11.4	7.11	4.03	2.91	2.33	1.98	1.28	1.09	0.59

## Constant Power Discharge Characteristics (Watt, 25°C)

F.V/TIME	10min	15min	30min	60min	2h	3h	4h	5h	8h	10h	20h
9.60V	325	260	146	90.3	49.9	36.4	29.2	24.8	16.2	13.6	7.31
9.90V	315	254	143	89.0	49.6	36.1	29.0	24.7	16.1	13.5	7.28
10.2V	302	244	138	86.7	49.1	35.9	28.8	24.5	16.0	13.5	7.24
10.5V	289	236	135	85.0	48.4	35.6	28.6	24.4	15.8	13.4	7.20
10.8V	273	224	130	82.4	47.2	34.6	27.7	23.6	15.4	13.1	7.06

Note: The above characteristics data can be obtained within three charge/discharge cycles.

**Discharge Characteristics(25°C)**

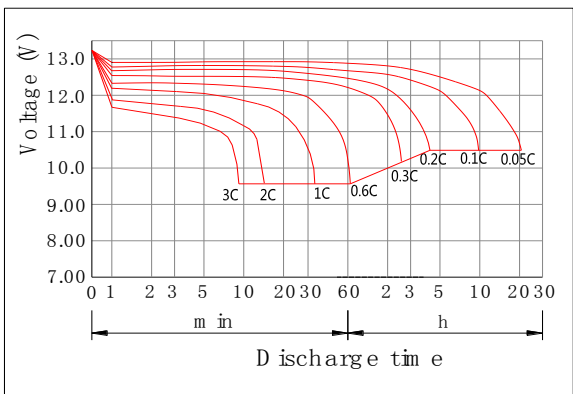

**Charging Characteristics(25°C)**

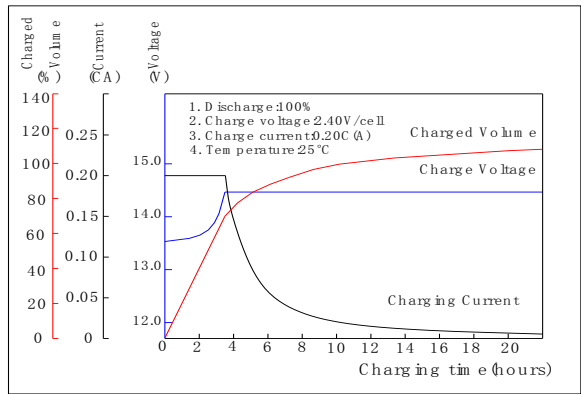

**Effect of Temperature on Capacity**

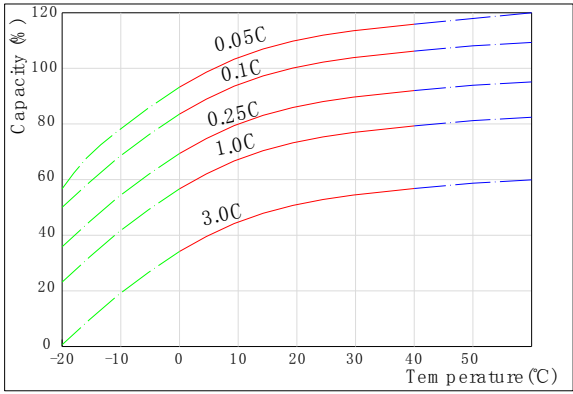

**Self-discharge Characteristics**

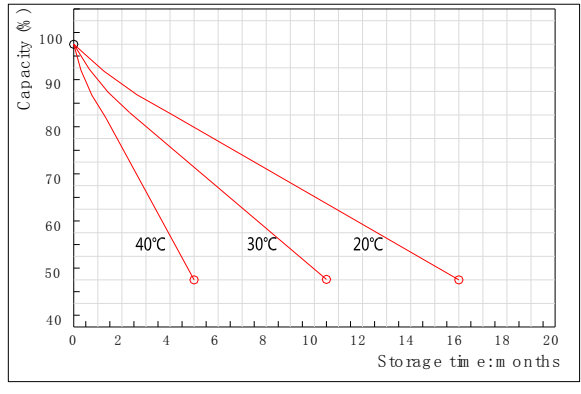

**The Relationship for Open Circuit Voltage and Residual Capacity (25°C)**

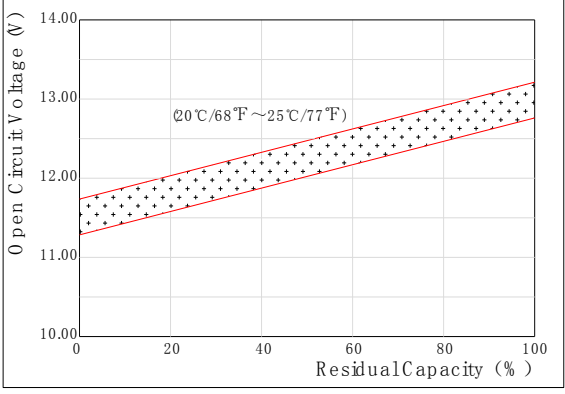

**The Relationship for Charging Voltage and Temperature**

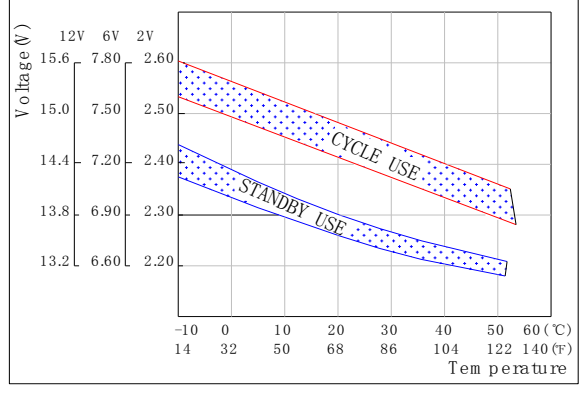

**Floating Life on Temperature**

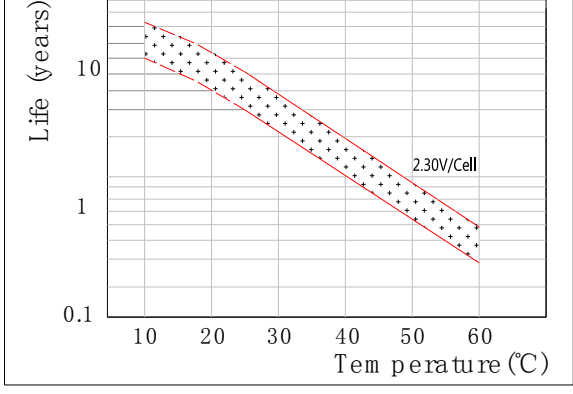

**Cycle Life on D.O.D(25°C)**

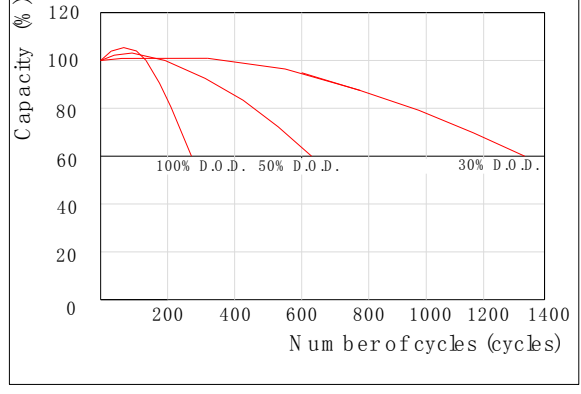



# Operating manual

# WÄRTSILÄ

# JOVYREC PME



## BAX 5675\_en



Wärsilä JOVYATLAS EUROATLAS GmbH  
Fennenweg 4, 26844 Jemgum, Germany  
[www.jovyatlas.de](http://www.jovyatlas.de)

Tel. +49 (0)4958 9394 - 0  
Fax. +49 (0)4958 9394 - 10

Index	Date	Name	Revision
0	18.09.2017	J.Schulte	First edition
1			
2			
3			
4			
5			
6			
7			
8			
9			
10			

## Important notes

### Please read these instructions carefully

These instructions contain specifications concerning safety, installation and work procedures that will help you put our product to optimal use. They must be read carefully before beginning assembly and installation of the product. They must be accessible to both the product's assembler and operator.

### Please keep these instructions in a safe place

They contain important specifications and notes concerning use of the product as well as notes concerning questions and problems.

### Validity

Our goods and services are subject to the general terms of delivery for products of the electronics industry as well as our general sales conditions. We reserve the right to make changes to these instructions – in particular as regards the technical data, operating instructions and the weights and dimensions – at any time. These instructions correspond to the product's technical version at the time of publication. Their contents are not part of any contract but are for information purposes only.

Wärtsilä JOVYATLAS EUROATLAS GmbH reserves the right to make substantive and technical changes regarding the content of these instructions without prior notification. Wärtsilä JOVYATLAS EUROATLAS GmbH cannot be held liable for any errors or inaccuracies in these instructions, as there is no obligation to provide regular updates.

### Complaints

Complaints must be submitted to the manufacturer at the latest eight days after delivery of the product.

### Copyright

Any disclosure, reproduction and/or copying of these instructions, by electronic or mechanical means, in whole or in part, requires the express prior written consent of Wärtsilä JOVYATLAS EUROATLAS GmbH.

Copyright Wärtsilä JOVYATLAS EUROATLAS GmbH. All rights reserved.

# Contents

<b>1</b>	<b>Notes on operating instructions to hand</b>	<b>4</b>
<b>2</b>	<b>General</b>	<b>4</b>
<b>3</b>	<b>General technical data</b>	<b>5</b>
<b>4</b>	<b>Mode of operation</b>	<b>6</b>
<b>5</b>	<b>Characteristic curve</b>	<b>6</b>
<b>6</b>	<b>Operation</b>	<b>7</b>
6.1	Circuit diagram of switching power supply	7
6.2	Electrical functional description of switching power	7
6.3	Reliable electrical disconnection	8
6.4	Input	8
6.5	Output	8
6.6	Parallel switching	8
6.7	LED-Display	9
6.8	Redundant system architecture	9
6.9	Interface settings	9

---

# 1 Notes on operating instructions to hand

## **CAUTION!**

Please read these operating instructions very carefully before installing and starting up the device.

The operating instructions are included as part of the scope of delivery of the device, i.e. they are made available without restriction to all persons commissioned with the startup, maintenance or operation of the device. The device may only be installed, commissioned, maintained and operated by qualified electrical engineering specialists. Country-specific accident prevention regulations of the respective end user in particular as well as the general guidelines in accordance with IEC 364 must be adhered to at all times!

The functional descriptions in the operating instructions correspond to the publication status. Technical or content related changes can be carried out at any time by the manufacturer without the need to issue an update or notification. There is no obligation to continuously update and adapt the operating instructions.

The devices fulfill the EN and VDE standards applicable at the time of publication. The CE symbol on the device confirms compliance with the 73/23 EEC Low Voltage and 89/339 EEC Electromagnetic Compatibility EU Framework Directives.

The devices are supplied exclusively in accordance with our delivery and sales conditions. The right to make changes to the technical data in these operating instructions as well as the associated data sheets is reserved at all times.

Complaints in relation to supplied goods should be submitted as quickly as possible following receipt of the goods and should be accompanied by the packing slip as well as the type designation, serial number and the objection.

All warranty claims of the customer lapse in the event of visible external interference (e.g. absence of or loose screw fittings, resoldering, loose boards, etc.) which indicate that the device has been opened inadmissibly.

The manufacturer accepts no liability in cases where the device is used for a purpose other than that intended by the manufacturer. Responsibility for measures required in such cases for avoiding injury to persons or damage to property is borne by the end user (see text above).

## 2 General

The PME switching power supply supplies a maximum output power of 2500W. The device was developed especially for the applications and requirements of the telecommunications market.

Typical applications include use as a mains supply or backup power supply with parallel switched battery. The good dynamic control properties are especially advantageous in this context in the event of input voltage changes and load surges.

The switching power supply operates on the basis of an IU characteristic curve as per DIN 41772/41773 combined with a constant power characteristic curve and represents a connection-ready unit for installation in various housing types. The device is equipped as standard with a LED display. The plug-in connectors for input and output as well as signalling are arranged on top.

### 3 General technical data

The technical data specified here applies for the entire device series.  
The device-specific values can be found in "Specific technical data".

<b>Mains power connection:</b>	1/N/PE 230V AC +15/-20% 45-66Hz
<b>Dynamic behavior:</b>	2 % with abrupt load changes between 90%-10%-90% I <sub>rated</sub> (transient time < 2ms at 1% U <sub>rated</sub> ).
<b>Short-circuit behavior:</b>	Short-circuit proof
<b>Switching on pattern:</b>	Softstart.
<b>Performance factor cos <math>\phi</math> :</b>	0.99 for P <sub>out</sub> = 100% P <sub>rated</sub> ; 0.97 for P <sub>out</sub> < 50% P <sub>rated</sub> ; 0.95 for P <sub>out</sub> < 25% P <sub>rated</sub> .
<b>Output ripple without battery:</b>	0.3% peak-to-peak for rated output voltage 24V to 220V
<b>Output ripple without battery frequency-weighted:</b>	24V – 1mV as per CCITT Standard 48 and 60V – 2mV as per CCITT Standard
<b>Characteristic curve:</b>	I <sub>U</sub> as per DIN41773
<b>Circuit:</b>	Primary synchronization based on principle of pulse width control.
<b>Clock frequency:</b>	65 kHz
<b>Reliable electrical disconnection:</b>	Up to 60V DC rated output voltage, protection from functional low voltage with reliable electrical disconnection as per EN60950. In excess of 60V DC rated voltage output, protection with reliable electrical disconnection as per EN60950.
<b>Surge category:</b>	2 (impulse withstand voltage 2 kV - 1.2/ 50 $\mu$ s).
<b>Rated insulation voltage of mains supply circuits:</b>	a) Air clearance 424V (peak value). b) Creepage distances in accordance with rated supply voltage (effective value).
<b>Noise level:</b>	£ 59 dB at one meter distance.
<b>Protection class:</b>	IP20 as per DIN 40050
<b>Cooling method:</b>	Self-cooling with temperature controlled fans
<b>Weight:</b>	5,5 kg
<b>Environmental conditions:</b>	a) Ambient temperature: -10°C to +40°C up to +55°C with power reduction. b) Relative humidity: 5% to 95% (at 40°C ambient temperature max. 50% relative humidity, at 28°C ambient temperature max. 95% relative humidity). c) Air pressure 86 kPa to 106 kPa. d) Degree of pollution 2
<b>Installation height:</b>	1000 meters above NN (sea level). Power reduction at greater heights.

## 4 Mode of operation

The mode of operation depends on the usage of the device.

The entire device current flows into the battery when batteries are charged without a DC consumer.

The rectifying device, battery and consumer are switched in parallel when charging batteries and supplying power to the DC consumers at the same time. The rectifying device supplies the consumers and keeps the battery fully charged (conservation charging) when the mains voltage is present. The battery only assists with supplying power when the load exceeds the rated device current. If the power fails, the battery takes over supplying power to the consumers without interruption. Once power has been restored, the consumers are again supplied by the device. The batteries are charged at the same time. The output current from the rectifying device is limited here to its rated current. The difference between the rated device current and the consumer current flows into the battery as charging current.

No batteries are connected if the DC consumers are supplied directly.

## 5 Characteristic curve

The voltage values below apply for PB cells and the values in brackets () for Bi-Cd cells.

The rectifying device operates with the IU characteristic curve as per DIN 41773. Unless specified otherwise in the technical data, the device supplies its rated current up to a battery voltage of 2.23 V/Z (1.4 V/Z) at a constant regulated level of within +/- 2 % (I characteristic curve). Once a level of 2.23 V/Z (1.4 V/Z) has been reached, the current flowing into the battery decreases constantly. The battery voltage is maintained at a constant level with a tolerance of +/- 1 % at this value (U characteristic curve / constant voltage).

The specified tolerances relate to the mains fluctuations of +15 to -20% and frequency changes of 45 – 66 Hz in a temperature range of between -10 and +40 degrees C.

The following options are possible:

- Manual heavy charging Uk2
- Automatic heavy charging
  - Voltage-controlled Lu or
  - Voltage and time-controlled Lt
- Manual transient charging with I characteristic curve.

### Typical output characteristic curve

Device-specific values can be found in the specific technical data.

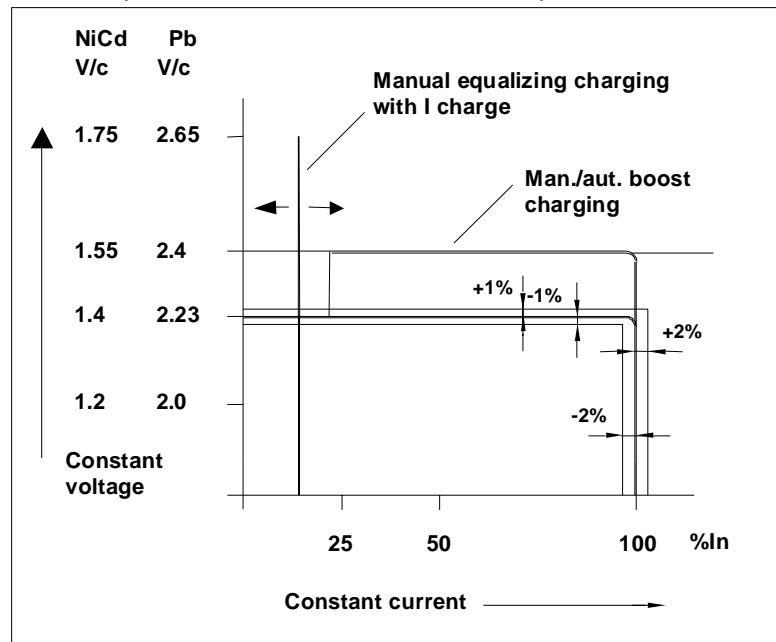

## 6 Operation

### 6.1 Circuit diagram of switching power supply

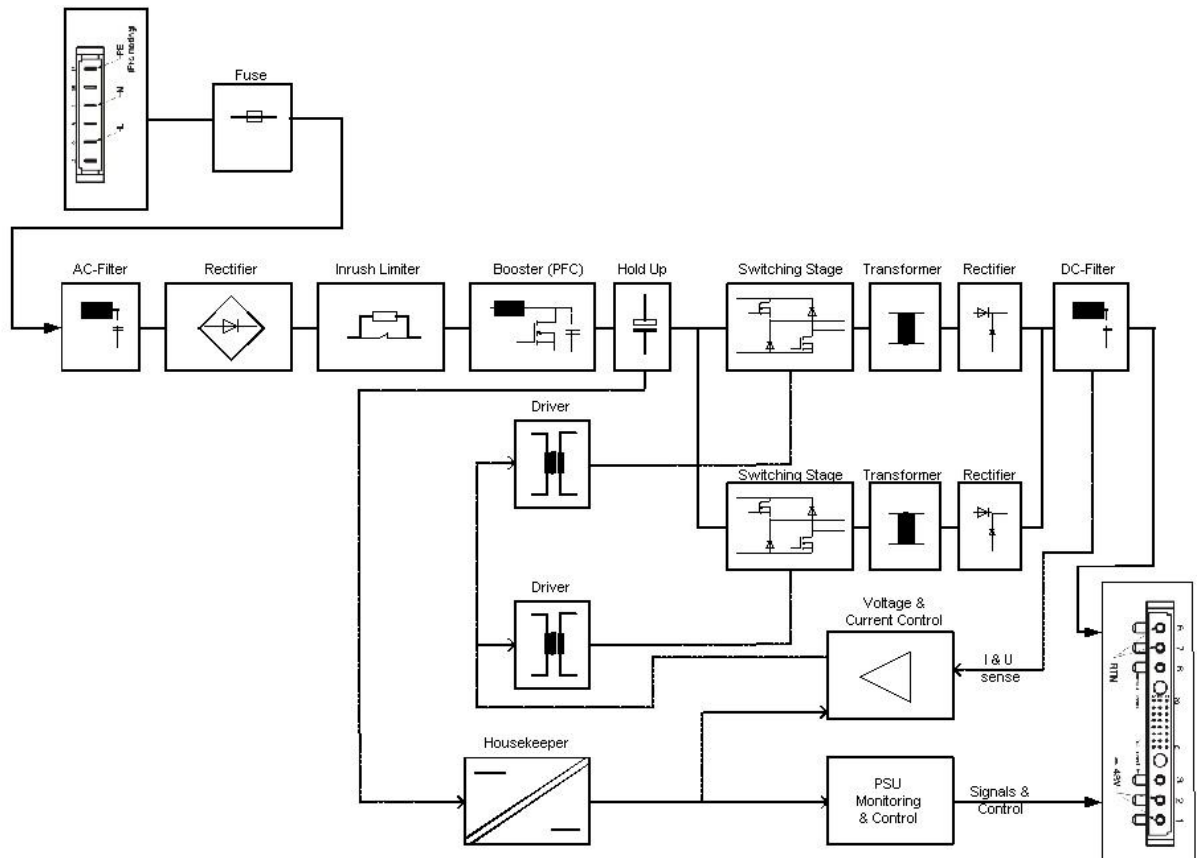

### 6.2 Electrical functional description of switching power

The switching power supply consists of the following main function blocks:

Mains filter for avoiding interspersions of high-frequency disturbances generated by the device into the mains power supply as well as for damping interfering voltages and voltage transients superimposed on the mains power supply.

Mains rectifier with synchronized boost converter (operating frequency 70 kHz) for converting the input voltage into a preregulated direct current of approx. 380V as well as for regulating the wave form of the input current (sinusoidal) and the power factor (> 0.99, as per EN 61000-3-2). Inrush current limiting is also performed based on series resistance with bypass relay.

Two transistor half bridges for converting the 380V DC to a pulse width regulated step-shaped AC voltage with a frequency of 65 kHz.

Two single-ended power converters for electrical isolation and impedance bridging on the secondary side.

Two rectifier levels with fast-switching power diodes and a common output, thereby frequency doubling to 130 kHz.

LC filter for smoothing the pulsating DC voltage at the rectifier output.

Output filter for avoiding interference voltages at the output voltage.

Auxiliary power supply for internal voltage supply to the primary and secondary controllers with electrical isolation.

Control process with electrical isolation through trigger transformer.

Control element with parameter setting, signaling, monitoring and display elements. Electrical isolation is performed by means of optocouplers.





## 6.7 LED-Display

If an error occurs, such as failure of the internal fan, the red LED lights up as well as a red LED on the interface.

(see Figure 7.9)

## 6.8 Redundant system architecture

The device is designed such that operation is only disrupted minimally if one of the device's main components fails unexpectedly.

If there is a fault in a switching power supply (PME), the affected PME disconnects from the common DC bus by means of an internal power relay so as not to impact the operation of any other PME's. Operation can be continued despite failure of a PME, but with reduced power.

## 6.9 Interface settings

