

V4NC

V4NC

- Characteristics
- wide variety of levers
 - peg mounting option
 - pre-wired option
 - sealed (IP6K7)
 - solder and faston terminals
 - PCB terminals

Rating 250 VAC, 5 A

Dimensions (mm) 20 × 10.3 × 6.4

- Actuator
- plunger
 - plain levers
 - roller levers
 - simulated roller levers

Approvals none



Preferred Range

Ordering Reference	Actuating Force (N)	Actuating Force (ozf)	Sealing	Operating pos.		Terminal	Circuit	Actuator	Contacts	Electrical rating
				(mm)	(in)					
V4NCT7	1.7	6.114	No symbol	8.40	0.331	Solder	CO	Plunger	Ag	250 VAC, 5 A
V4NCT7A1	0.8	2.877	No symbol	10.85	0.427	Solder	CO	Plain lever	Ag	250 VAC, 5 A
V4NCT7AR	0.8	2.877	No symbol	16.00	0.630	Solder	CO	Roller lever	Ag	250 VAC, 5 A
V4NCS	2.5	8.992	Sealed IP6K7	8.40	0.331	Cable 500 mm	CO	Plunger	Ag	250 VAC, 5 A
V4NCSA1	0.9	3.237	Sealed IP6K7	10.80	0.425	Cable 500 mm	CO	Plain lever	Ag	250 VAC, 5 A
V4NCSAR	0.9	3.237	Sealed IP6K7	15.90	0.626	Cable 500 mm	CO	Roller lever	Ag	250 VAC, 5 A

V4NC

Specifications

Housing	Glass fibre reinforced Polyamide (PA 6.6)
Plunger	Polyacetal POM/(PA 4.6)
Mechanism	Snap-action coil spring mechanism with stainless steel spring
Functions	Change-over, normally closed or normally open
Contacts	Fine Silver, Gold plate on silver, Gold alloy on silver palladium (crosspoint)
Terminals	Gold flashed
Temperature range °C	-40°C to +85°C/120°C
Mechanical life	5 × 10 ⁶ cycles minimum (impact free actuation) for the cowl 3 × 10 ⁶
Protection	IP40, IP6K7 (depend on type), Flux-proof terminal entries (for all types)
Mounting	Side mounting (moulded mounting pegs on request)
Actuators	Plain lever, cam follower, roller lever, simulated roller (cam follower) lever
Accessories	Lug mounting frame, clip-on terminals cover, insulating sheet

Circuit diagram

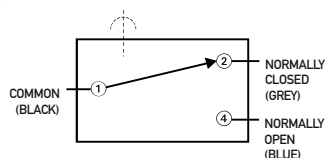

Dimensions

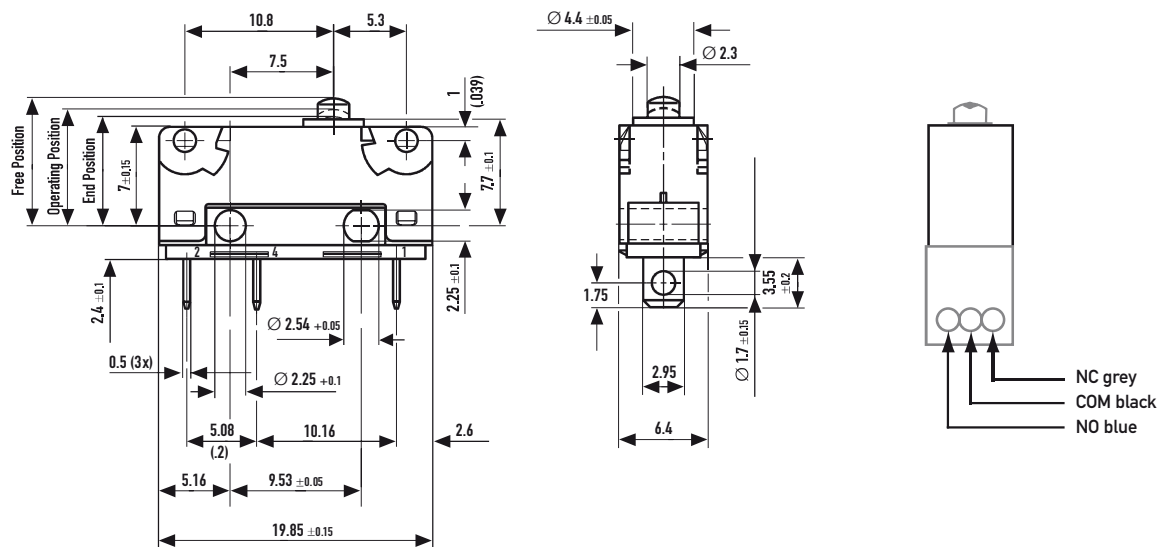

Prewired version with cable box

For type coding key please contact Saia

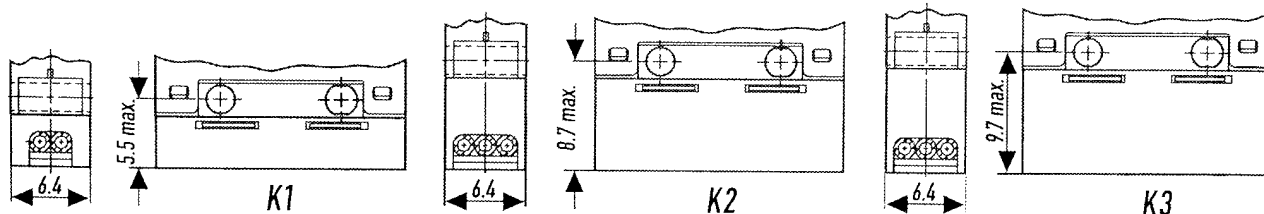

Standard cable FLRY 0.5 mm² with max. outside diameter 1.8 mm
Standard cable box is K2

V4NC

Operating Characteristics

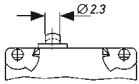
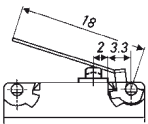
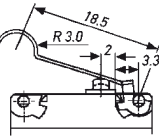
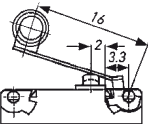
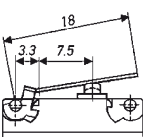
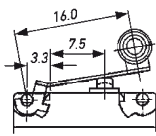
Actuator	Reference	Actuating Force Maximum		Release Force Minimum		Free Position Maximum		Operating Position		Movement Differential Maximum	
		(N)	(ozf)	(N)	(ozf)	(mm)	(in)	(mm)	(in)	(mm)	(in)
	V4NC..	1.7	6.114	0.3	1.079	9.2	0.362	8,4 ± 0.3	0.331 ± 0.012	0.1	0.004
	V4NCE..	1.7	6.114	0.3	1.079	9.7	0.382	8,9 ± 0.3	0.35 ± 0.012	0.1	0.004
	V4NCS..	2.5	8.992	0.5	1.798	9.2	0.362	8,4 ± 0.3	0.331 ± 0.012	0.1	0.004
	V4NCSE..	2.5	8.992	0.5	1.798	9.7	0.382	8,9 ± 0.3	0.35 ± 0.012	0.1	0.004
	V4NC..	0.8	2.877	0.07	0.251	13.4	0.527	10,85 ± 1.3	0.427 ± 0.051	0.4	0.016
	V4NCE..	0.8	2.877	0.07	0.251	14.8	0.582	12,4 ± 1.3	0.488 ± 0.051	0.4	0.016
	V4NCS..	0.9	3.237	0.1	0.359	13.4	0.527	10,8 ± 1.3	0.425 ± 0.051	0.4	0.016
	V4NCSE..	0.9	3.237	0.1	0.359	14.8	0.582	12,4 ± 1.3	0.488 ± 0.051	0.4	0.016
Width of lever 4.0mm/0.16 in											
	V4NC..	0.8	2.877	0.07	0.251	16.1	0.634	13,5 ± 1.3	0.531 ± 0.051	0.4	0.016
	V4NCE..	0.8	2.877	0.07	0.251	17.6	0.693	15,1 ± 1.3	0.594 ± 0.051	0.4	0.016
	V4NCS..	0.9	3.237	0.1	0.359	16.1	0.634	13,4 ± 1.3	0.527 ± 0.051	0.4	0.016
	V4NCSE..	0.9	3.237	0.1	0.359	17.6	0.693	15,1 ± 1.3	0.594 ± 0.051	0.4	0.016
Width of lever 4.0mm/0.16 in											
	V4NC..	0.8	2.877	0.07	0.251	18.1	0.712	16 ± 1.2	0.63 ± 0.047	0.4	0.016
	V4NCE..	0.8	2.877	0.07	0.251	19.2	0.756	17,3 ± 1.2	0.681 ± 0.047	0.4	0.016
	V4NCS..	0.9	3.237	0.1	0.359	18.1	0.712	15,9 ± 1.2	0.626 ± 0.047	0.4	0.016
	V4NCSE..	0.9	3.237	0.1	0.359	19.2	0.756	17,3 ± 1.2	0.681 ± 0.047	0.4	0.016
Width of lever 4.0mm/0.16 in											
	V4NC..	1.3	4.676	0.13	0.467	10.7	0.421	9,4 - ± 0.7	0.37 ± 0.027	0.2	0.008
	V4NCE..	1.3	4.676	0.13	0.467	11.5	0.453	10,2 ± 0.7	0.401 ± 0.027	0.2	0.008
	V4NCS..	1.8	6.474	0.2	0.719	10.7	0.421	9,3- ± 0.7	0.366 ± 0.027	0.2	0.008
	V4NCSE..	1.8	6.474	0.2	0.719	11.5	0.453	10,1 ± 0.7	0.397 ± 0.027	0.2	0.008
Width of lever 4.0mm/0.16 in											
	V4NC..	1.3	4.676	0.13	0.467	15.8	0.622	14,7 ± 0.6	0.579 ± 0.023	0.2	0.008
	V4NCE..	1.3	4.676	0.13	0.467	16.5	0.649	15,4 ± 0.6	0.606 ± 0.023	0.2	0.008
	V4NCS..	1.8	6.474	0.2	0.719	15.8	0.622	14,7 ± 0.6	0.579 ± 0.023	0.2	0.008
	V4NCSE..	1.8	6.474	0.2	0.719	16.5	0.649	15,4 ± 0.6	0.606 ± 0.023	0.2	0.008
Width of lever 4.0mm/0.16 in											

Operating characteristics shown above are specified from mounting hole centres.

Over travel: Flush with case. (7.8 mm min) The case should not be used as an end stop.

Subminiature

V4NC

Ordering Reference

Basic type	V4NC	Example: V4NC	E	T7	C2	A1	0	G
Actuating Force	No symbol, standard force							
Type of sealing	No symbol, unsealed, standard travel							
	E	Unsealed	with extended overtravel (0.5 mm)					
	S	Sealed IP6K7	standard travel					
	B	Sealed IP6K7	with extended overtravel (0.5 mm)					
Terminals	No symbol, pre-wired 500 mm with cable box (V4NCS/B only)							
	T7	Solder	2.95 × 0.5 × 3.55 long					
	T8	PCB	0.8 × 0.5 × 4.0 long					
	T9	Faston	2.8 × 0.5 × 9.5 long					
	T81	Formed PCB	0.8 × 0.5 × 3.8 long					
	T82	Formed PCB	0.8 × 0.5 × 3.8 long					
	T84	Short PCB	0.8 × 0.5 × 2.0 long					
	T85	Long PCB	0.8 × 0.5 × 6.85 long					
	T11	Welding/solder	2.95 × 0.5 × 3.55 long					
Circuit	No symbol, change-over							
	C2	Normally closed						
	C4	Normally open						
Actuators	No symbol, without lever							
	A1	Plain lever	18.0 mm					
	A2	Plain lever	25.0 mm					
	A3	Plain lever	32.0 mm					
	A7	Plain lever	60.0 mm					
	AC	Cam follower lever	18.5 mm (AC1)					
	AR	Roller lever	16.0 mm (AR1)					
	AP	Roller lever	17.9 mm (AR2)					
	PB	Push Button	(see specification PBA4/QA4)					
	QA	Push Button	(see specification PBA4/QA4)					
	Other actuators on special request							
Actuator Position	No symbol, without lever, or lever fitted at the end nearest to the Plunger							
	0	With lever fitted at end opposite to plunger						
Contact Material	No symbol, Ag							
	G	Gold plate on silver (GP)						
	X	Gold alloy on silver palladium crosspoint (AUX)						
	Other contact materials on special request							
Special Features	/ <input type="checkbox"/> <input type="checkbox"/> <input type="checkbox"/> <input type="checkbox"/> Saia specialise in customer specific solutions. Additional product variants are available or can be provided. If your requirements cannot be satisfied from the options listed, please contact www.saia-burgess.com or your local SB outlet.							

Subminiature